

**NOW! Tables - ships in 10 days**

**Boat Shape - Panel End Base - WoodPlus Laminates ONLY**

Description	Model Number	Depth	Length	Wgt	List Prices	
					WoodPlus	Standard
<b>36" wide, 18" wide base</b>	TB3672-PEB	36	72	130	<b>1785</b>	1938
	Top: 1 piece; Base: 2 PEB					
<b>48" wide, 24" wide base</b>	TB4896-PEB	48	96	206	<b>2273</b>	2440
	TB48120-PEB	48	120	250	<b>2804</b>	3038
Top: 1 piece; Base: 2 PEB.						

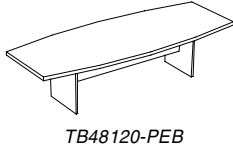

TB48120-PEB

**Boat Shape - Radius Cube Base - WoodPlus Laminates**

<b>48" wide</b>	TB4896-RC	48	96	344	<b>4030</b>	4230
<b>24" wide base</b>	TB48120-RC	48	120	424	<b>4336</b>	4570
	Top: 1 piece; Base: 2 RC.					

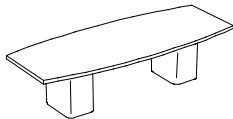

TB48120-RC

**Racetrack Shape - Half Cylinder Base - WoodPlus Laminates**

<b>36" wide, 18" wide base</b>	TR3672-HC	36	72	246	<b>2671</b>	2866
	Top: 1 piece; Base: 2 HC					
<b>42" wide, 18" wide base</b>	TR4296-HC	42	96	296	<b>3157</b>	3357
	Top: 1 piece; Base: 2 HC					
<b>48" wide, 24" wide base</b>	TR48120-HC	48	120	424	<b>3500</b>	3734
	Top: 1 piece; Base: 2 HC					

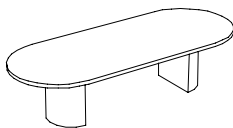

TR48120-HC

\* Conference tables on this page qualify for MAGNA NOW! 10 day shipping program. You must specify MAGNA NOW! on your purchase order. For large orders, please check with Customer Service since factory volume may affect leadtime.

**IMPORTANT:** Tables are standard with wood grain running length of table.

October 2007, Magna Design, Inc.

CMR-3

**Magna NOW! conference tables - available in 10 days\***

# Ordering Information - Quick Spec

## Order Examples with required Quick Spec information:

Qty	Model Number	Top Edge	Top Finish	Top Edge Finish	Vertical Finish	Vertical Edge Finish	Pull Number	Option 1	Option 2	Option 3
1	TR58120-ACE-HC	2100	WP23	W23	WP23					
2	TDE58216-RC	3200	WP41	W31	WP31					
1	STV8-3684-24	CL	WP61	W41	WP61	WP61	13	UPD	LHD	TVT-SH
1	ST8-2LF-3084-24-LOCK	CL	WP61	W41	WP61	WP61	13	UHD		
1	PDB-4872-WPE				WP41	WP41		PS		
1	CRL-MF-3430-RACK-WP2		WP2-61		WP2-88			UD	CA	
1	TT3672-CLEG	WPES	WP81	CP88						
2	TB-BE-46168-ACE-RC-WP2		CP2-28		WP2-71					

## Required Order information

Quantity required

Model Number as shown in Price Catalogs

Top Edge required (with few exceptions such as WP2 finish colors and Accessories)

Finish Colors: varies by product chosen

Pull Number (if there are drawers or doors, excluding ACT tables)

Options: as required

## Finish Colors, Pulls, Top Edges

### WoodPlus tops

WP-31 Medium Cherry  
 WP-71 Dark Cherry  
 WP-73 Cognac  
 WP-48 Sipp'g Seattle Java-1  
 WP-41 Natural Maple  
 WP-81 Fusion Maple  
 WP-45 Anigre  
 WP-23 Cordovan  
 WP-61 Pear  
 WP-04 Solar Oak

### WoodPlus verticals

All WoodPlus top colors plus  
 CP-76 Espresso  
 CP-98 Slate  
 CP-88 Black

### WoodPlus XTRA tops

WP-05 Rift Oak  
 WP-15 Midnight - 1,3  
 WP-33 Blossom Cherry - 2  
 WP-35 Golden Cherry - 3  
 WP-37 Mocha Cherry - 3  
 WP-67 Chocolate Pear - 3  
 WP-75 Chestnut

### WoodPlus XTRA verticals

- Hi-Brite table tops, worksurfaces All other surfaces are suede texture.
- Hi-Lustre table tops, worksurfaces All other surfaces are suede texture.
- No matching 3mm WPE edge

### WoodPlus2 tops only

CP2-28 Med Grey Speckle  
 CP2-38 Beige Speckle.

### WoodPlus2 tops and verticals

WP2-45 Anigre  
 WP2-71 Dark Cherry  
 WP2-81 Fusion Maple  
 WP2-31 Medium Cherry  
 WP2-41 Natural Maple  
 WP2-61 Pear

### WoodPlus2 verticals only

CP-76 Espresso  
 CP-98 Slate  
 CP-88 Black

### WoodPlus2 XTRA tops only

WP2-18 Shadow Oak  
 WP2-65 Beech  
 CP2-74 Platinum  
 CP2-78 Bronze  
 CP2-72 Shark Gray  
 CP2-80 Cashmere Fiber

Upcharge for XTRA WoodPlus and XTRA WoodPlus2 finishes is \$600 per finish per order.

For additional finishes please see the finish section on our website at <http://www.magnadesign.com> or contact Customer Service for details at 800-233-2304.

## All edges available on WoodPlus ACT and Conference tables

WoodPlus 3mm PVC Equations	Standard Wood Equations	Detailed Wood	2000 Wood	3000 Wood	WP2 Table, Credenza, Towers, Lecterns
<b>Modular 8</b> 	<b>Modular 8</b> 				

WPK or STDK 'reverse knife' edge is available with 3mm PVC (WPK) or 3mm wood (STDK) edge, see reverse knife edge pricing page.

For Modular tables, Credenzas, Towers, Lecterns

## Conference and Meeting Products - Table of Contents

<b>MAGNA NOW! tables - ship in 10 business days</b> .....	<b>3</b>
<b>How to order</b> .....	<b>4</b>
<b>General Information</b> .....	<b>7</b>
<b>Planning Information and Room Layouts</b> .....	<b>9</b>
<b>Specifications</b> .....	<b>15</b>
<b>Finishes</b> .....	<b>19</b>
<b>ACT Tables</b> .....	<b>21</b>

*Basic shape options:*

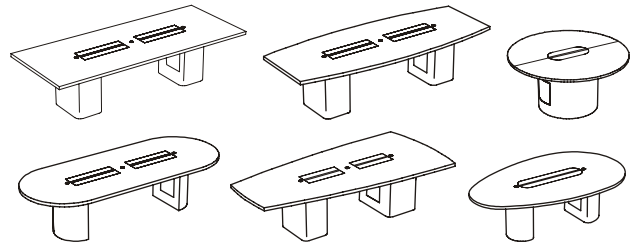

<b>MINI - ACT units and options</b> .....	<b>54</b>
<b>Conference Tables</b> .....	<b>59</b>

*Basic shape options:*

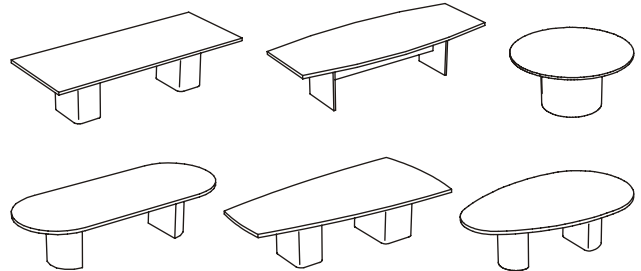

<b>Modular Conference tables</b> .....	<b>91</b>
<b>Modular Tables and Modular Assemblies</b> .....	<b>101</b>

*Basic top and base options:*

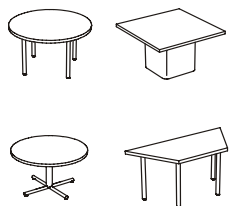

*Assemblies:*

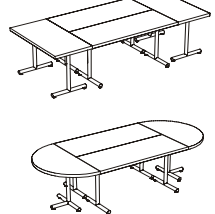

# Conference and Meeting Products - Table of Contents

Presentation Units, Marker Boards, Multimedia Lecterns ..... 115

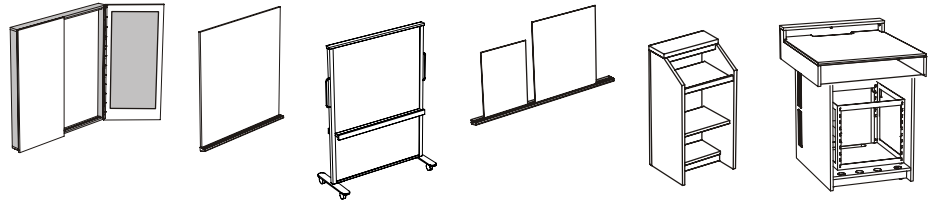

Credenzas & Occasional Tables ..... 123

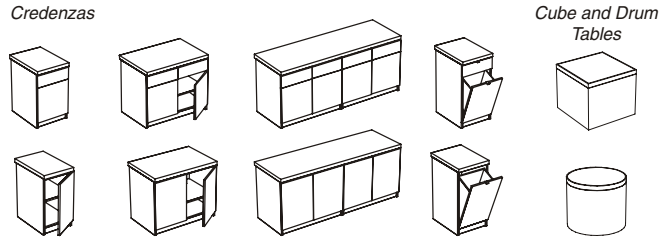

Storage Towers ..... 137

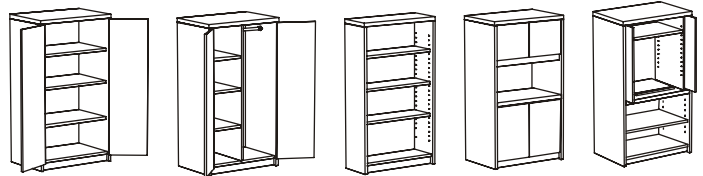

Mobile Units ..... 153

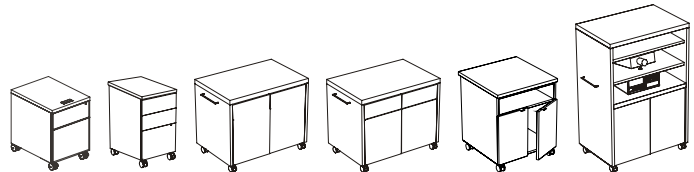

Index at back of price list ..... 157



## Pricing and Delivery Information

### PRICES:

Prices are subject to change without notice and the price list with the later date supersedes all previous price lists.

Prices do not include charges for cartoning, installation, or inside delivery.

Cartoning charges will be added to orders weighing under 250 lb.

### DELIVERY:

All prices include delivery outside the Zone 1 region.

Zone 1 includes Washington, Oregon, Alaska, Hawaii, and British Columbia. Prices in Zone 1 reflect Factory Will Call. Zone 1 dealer discounts are adjusted accordingly.

A freight surcharge will be added to Zone 2 orders totaling less than \$10,000 LIST. The freight surcharge will be 10% of NET invoice total.

A Fuel Surcharge will be added to all invoices that include delivery.

Please see our website <http://www.magnadesign.com> for current details.

Standard delivery will be made on a dock-to-dock basis or to a sidewalk. Should you have special requirements such as inside delivery or prior notification please contact Magna Design's traffic department. Special delivery requirements will be handled on an as-available basis and will likely result in additional charges.

All Shipments are FOB Magna Plant, Lynnwood, Washington.

## MAGNACAD INFORMATION



MagnaCad

The MagnaCad graphic drawing and presentation software package includes the complete symbol libraries for 2D layout drawings and 3D isometric illustrations. Magna product Symbol libraries are linked directly to specification and pricing information.

Product graphic and specification packages are available for use with 20-20's GIZA software, Data One's Design Express software and Project Matrix's Project Spec software. Software such as 20-20 GIZA, Design Express or Project Spec may be purchased directly from the software provider. Magna provides just the graphic and specification information for our product lines that can be used in these third party software products.

## LIFETIME LIMITED WARRANTY

Magna Design warrants that its conference room products are free from defects in design, material and workmanship under normal single shift use and with proper care and maintenance. This lifetime warranty will remain in effect commencing with the date of purchase from Magna Design but only so long as the original purchaser continues to own the product. This lifetime warranty applies to all product and components not excluded below:

WoodPlus2 finishes on products purchased January 2002 or later - **LIFETIME**

Drawer slides - **LIFETIME**

**LIFETIME for ALL PRODUCT and COMPONENTS**, not listed below

Healthcare products - **ten (10) years**

Electrical components and functional mechanisms, like keyboard trays - **five (5) years**

Wood finishes - **three (3) years.**

During the term of this Warranty, MAGNA DESIGN will repair or replace with the same or comparable product or part without charge any product or part that malfunctions or fails to conform to this Warranty. THIS REMEDY OF REPAIR OR REPLACEMENT IS PURCHASER'S SOLE AND EXCLUSIVE REMEDY WITH REGARD TO ANY PRODUCT DEFECT.

This Warranty does not apply to:

- Any damage caused during shipment.
- Any product installed or used other than in accordance with MAGNA DESIGN guidelines.
- Any product that has been repaired, altered, or modified by any person other than MAGNA DESIGN.
- Any attachment added to a product.
- Any fabric or upholstery material.
- Any part or material provided by Purchaser.
- Any damage caused by misuse, abuse, or negligence on the part of Purchaser or any third party.

THERE ARE NO OTHER WARRANTIES, EITHER EXPRESSED OR IMPLIED, INCLUDING ANY WARRANTY OF MERCHANTABILITY OR OF FITNESS FOR A PARTICULAR PURPOSE. UNDER NO CIRCUMSTANCES WILL MAGNA DESIGN BE LIABLE FOR ANY CONSEQUENTIAL OR INCIDENTAL DAMAGES ARISING FROM ANY PRODUCT DEFECT.

This warranty is in effect for products shipped on or after **May 1, 1998**.

## Terms and Conditions

### QUOTATIONS:

Price quotations on non-catalog or special orders will not be valid after thirty (30) days without written approval from Magna Design, Inc.

### CREDIT TERMS

Net thirty (30) days after invoice date upon credit approval.

### ORDERING :

When ordering, please include complete identification and description of the product being ordered using Magna specifications and terminology. All orders must be in writing.

### TELEPHONE ORDERS:

All telephone orders must be confirmed with a written purchase order.

### ACKNOWLEDGMENTS:

All orders when accepted will be acknowledged by mail indicating the terms and conditions by which the order was accepted and a description of the items being ordered. Orders will be completed and shipped in accordance with the information on the acknowledgment and the purchaser intent. If the acknowledged information is incorrect we must receive written instruction to change.

### CHANGE ORDERS:

Order entry will take place upon receipt of a purchase order from an authorized Magna Design dealer. Subsequent order changes will be subject to a minimum \$25 processing fee. Actual change order charges may be higher depending on the status of the job at the time a change is made.

### CANCELLATIONS:

A 15% minimum restocking charge will be applied on cancellations of standard products. Cancellations will not be accepted on special or custom products.

### CUSTOM OR SPECIALS:

A 50% deposit may be required on special or custom product orders. Returns or cancellations on special or custom products will not be accepted.

### RETURNED GOODS:

Returned merchandise will not be accepted for return without twenty (20) days prior written notice and written Returned Goods Authorization (RGA) from Magna. Returned goods will be subject to a minimum 15% restocking and refurbishing charge in addition to shipping costs. (See Warranty policy for defective goods.)

### LEAD TIMES:

To current accounts with approved credit, *enterable* orders will be made available (in standard finishes) within 2 to 6 weeks depending upon shipping program: Magna NOW! or Magna FLEX. All orders are subject to current inventories. Leadtimes may vary according to factory volume.

### DELIVERY:

Orders will be delivered in accordance with the delivery dates indicated on the order acknowledgment and partial shipments may be made unless the order instructions indicate that an order must be shipped complete.

### SHIPPING:

We reserve the right to use our own discretion in selecting routes and freight carriers. We will attempt to meet any special routing requirements that you may have but assume no liability for damages or costs incurred by our inability to do so.

### FUEL SURCHARGE:

Effective June 1, 2007, we implemented a fuel surcharge. Please contact customer service or visit our website for current information.

### STORAGE:

Storage charges will be charged on orders not accepted or picked up within five (5) days of acknowledged delivery dates unless we are notified thirty (30) days in advance. Storage will be charged at the rate of 2% for the first fifteen (15) days delay and 3% for each fifteen (15) day period thereafter.

### FREIGHT CLAIMS:

Before signing a delivery receipt, make certain that goods are inspected for possible damage. If there is visual damage, record the extent of the damage on all copies of the bill of lading before signing. If there is no visual damage to goods that are cartoned or crated, we strongly suggest that the merchandise be unpacked and inspected immediately. If damages are discovered, save the packaging and contact the carrier immediately for inspection. Claims for damages should be filed with the delivering carrier and payment for the goods may not be withheld pending settlement of the carrier damage claims. Magna assumes no liability for freight damage or the workmanship or cost of repairs made by others without prior written authorization.

### SPECIFICATIONS:

All published dimensions and weights are approximate and we assume no liability for errors or inaccuracies in product literature. We reserve the right to modify or change product design and/or delete product models without prior notice.

### FINISHES:

We take great care in matching color and texture of materials in our product. However, it is impossible to guarantee exact matching in all cases.

# Planning Information and Room Layouts

## Family of Products

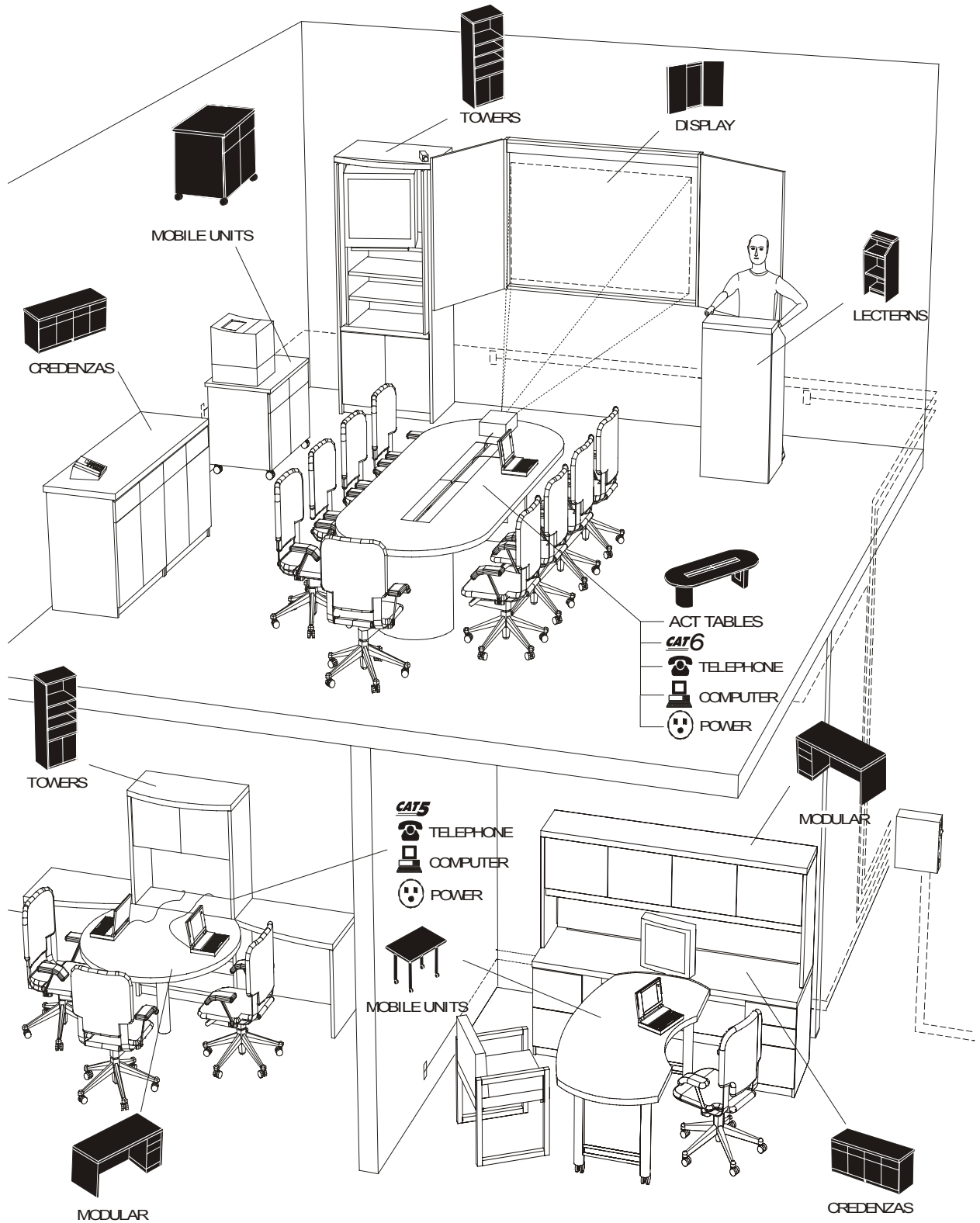

# Planning Information and Room Layouts

## Table edges

Applied Edge Profiles - not all edges available on all products

WoodPlus Edge Profiles - all are 3mm thick

**WPE**  
3 mm PVC

View of top section

3 mm

1 3/4" or 1 1/2" or 1 1/8"

Tops are 1 3/4" thick

**WPMS** WoodPlus Smooth

**WPMR** WoodPlus Reeded

**WPMN** WoodPlus Neo Classic

Tops are 1 1/2" thick

**WPFS** WoodPlus Smooth

**WFR** WoodPlus Reeded

**WPFN** WoodPlus Neo Classic

Tops are 1 1/8" thick

**WPES** WoodPlus Smooth

**WPER** WoodPlus Reeded

**WPEN** WoodPlus Neo Classic

Wood Edge Profiles - all are 3mm thick

**STD**  
3mm  
Hardwood

View of top section

3 mm

1 3/4" or 1 1/2" or 1 1/8"

Tops are 1 3/4" thick

**SWMS** Wood edge Smooth

**SWMR** Wood edge Reeded

**SWMN** Wood edge Neo Classic

Tops are 1 1/2" thick

**SWFS** Wood edge Smooth

**SWFR** Wood edge Reeded

**SWFN** Wood edge Neo Classic

Tops are 1 1/8" thick

**SWES** Wood edge Smooth

**SWER** Wood edge Reeded

**SWEN** Wood edge Neo Classic

Detailed Wood Edges - all are 3/8" thick

**DET**  
3/8"  
Hardwood

View of top section

3/8"

1 3/4"

**RE** Reeded

**RA** Radius

**BE** Beveled

**TR** Transitional

**CL** Classic

2000 Wood edge - all are 1 3/4" thick

**2000**  
3/4" to 2"  
Hardwood

Top section 2000 - 2004

3/4"

1 3/4"

**2000** **2001** **2002** **2003** **2004**

Top section 1000 - 1200

1 1/2"

1 3/4"

**1000** **1100** **1200**

Top section 2100 - 2200

2"

1 3/4"

**2200** **2100**

3000 Wood edge

**3000**  
3"  
Hardwood

**3200** 3" 1 3/4" **3200**

**3400** 3" 1 1/4" **3400**

## Reverse knife edge

# Planning Information and Room Layouts

## Knife Edge Information and Pricing

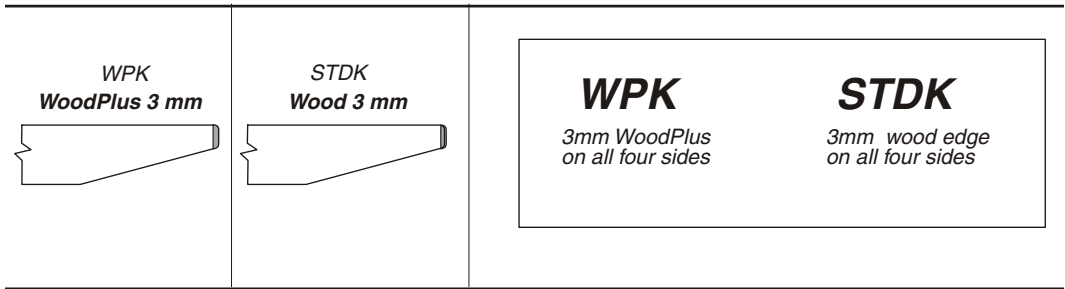

Upcharge for reverse knife edge. Specify either a 3mm WPK PVC edge or a 3mm STDK hardwood edge finish.

Table length or diameter	List Price	
round 58" or less	<b>542</b>	add to the WPE edge price
round 66" or 72"	<b>814</b>	add to the WPE edge price
table 60" long or less	<b>542</b>	add to the WPE edge price
table 72 long	<b>814</b>	add to the WPE edge price
table 84 long	<b>1037</b>	add to the WPE edge price
table 96 long	<b>1077</b>	add to the WPE edge price
table 120 long	<b>1257</b>	add to the WPE edge price
table 144 long	<b>1397</b>	add to the WPE edge price
table 150 long	<b>1397</b>	add to the WPE edge price
table 168 long	<b>1548</b>	add to the WPE edge price
table 180 long	<b>1548</b>	add to the WPE edge price
table 192 long	<b>1701</b>	add to the WPE edge price
table 216 long	<b>1701</b>	add to the WPE edge price
table 240 long	<b>1952</b>	add to the WPE edge price
table 288 long	<b>2388</b>	add to the WPE edge price
Kaizen table	<b>1610</b>	add to the WPE edge price
Wing table	<b>3472</b>	add to the WPE edge price

WoodPlus  
WPK edge

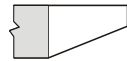

Hardwood  
STDK edge

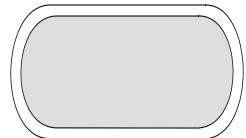
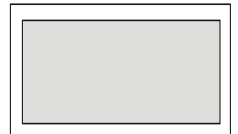
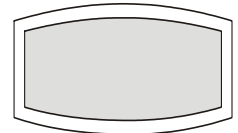
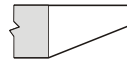

*Reverse Knife edge is on all sides of table top*

# Planning Information and Room Layouts

## Table Seating Capacity

### Standard Table Top Shapes and Sizes

Shape	Sizes	Seating Capacities
<b>Round or Square</b>	30D.....	2 Seats
	36D.....	2 or 3 Seats
	42D or 48D.....	4 Seats
	54D.....	5 Seats
	58D or 60D.....	5 or 6 Seats
	66D or 72D.....	6 Seats
<b>Egg</b>	5896.....	7 Seats
<b>Rectangular, Arrow</b>	4872.....	6 Seats
	4884.....	6 Seats
	4896.....	6-8 Seats
	48120.....	8-10 Seats
	48144.....	10-12 Seats
	48150.....	10-12 Seats
	48168.....	12 seats
	58120.....	10 Seats
	58144.....	12 Seats
	58150.....	12 Seats
	58168.....	12 Seats
	58180.....	12-14 Seats
	58192.....	14 Seats
	58216.....	16 Seats
	58240.....	18 Seats
58288.....	20-22 Seats	
<b>Boat</b>	4872.....	6 Seats
	4884.....	6 Seats
	4896.....	6-8 Seats
	48120.....	8-10 Seats
	48144.....	10-12 Seats
	48150.....	10-12 Seats
	48168.....	12 Seats
<b>Boat and Delta</b>	58120.....	8-10 Seats
	58144.....	10 Seats
	58150.....	10-12 seats
	58168.....	12 Seats
	58180.....	12-14 Seats
	58192.....	14 Seats
	58216.....	16 seats
	58240.....	18 Seats
	58288.....	20-22 Seats
	<b>Racetrack</b>	4872.....
4884.....		6 Seats
4896.....		6-8 Seats
48120.....		8-10 Seats
48144.....		8-12 Seats
48150.....		10 Seats
48168.....		10-12 Seats
58120.....		8-10 Seats
58144.....		8-10 Seats
58150.....		10-12 Seats
58168.....		10-12 Seats
58180.....		12-14 Seats
58192.....		12-14 Seats
58216.....		14-16 Seats
58240.....		16-18 Seats
58288.....	20-22 Seats	

### Examples

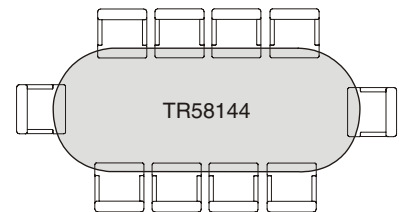
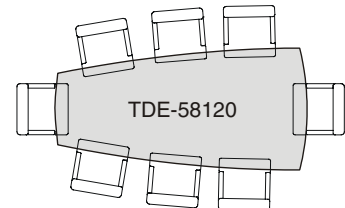
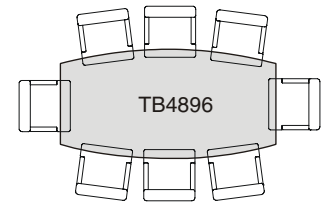
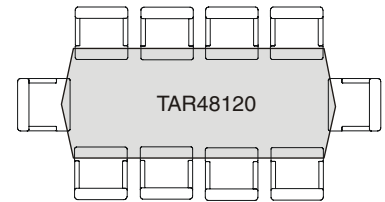
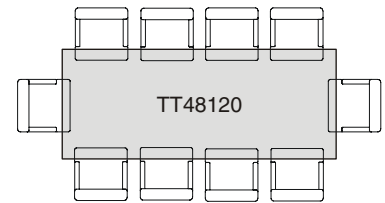
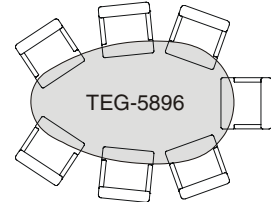
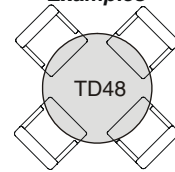

## Planning Information and Room Layouts

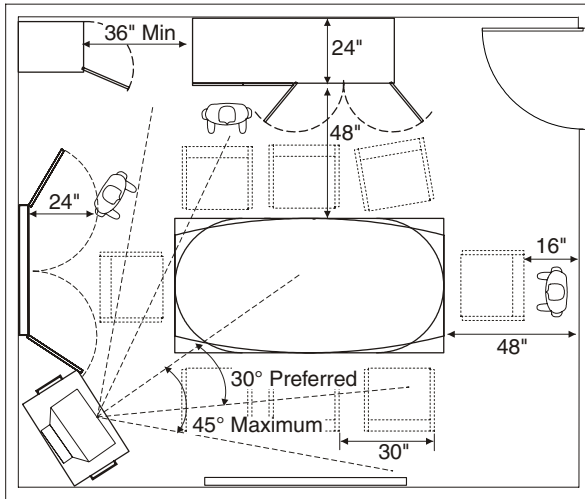

### Spacing

- ✦ Allow 48" between table and wall for minimum clearances
- ✦ Allow 60" between table and wall for primary aisle space
- ✦ Allow 24" to walk between chair and wall without turning sideways
- ✦ Allow 30" side to side per chair
- ✦ Allow 32" to 34" between table and back of chair to rise from chair
- ✦ Allow 38" to 40" between table and back of chair to rise from chair when confined by other sitters
- ✦ Allow 56" between table and visual display board with 24" doors (VDB4848)
- ✦ Allow 68" between table and visual display board with 36" doors (VDB4872)
- ✦ Allow 36" bending space to use under counter cabinets or lower shelves of bookcase
- ✦ Allow 72" between table and wall for 24" deep Storage Towers and Credenzas
- ✦ Allow 30" between table and back of chair to use Keyboard
- ✦ Allow 24" to 30" for standing and presenting material on wall
- ✦ TV or Monitor viewing preferred at 30° from center of screen; 45° maximum

### Definitions:

**Seating Capacity:** Chart below shows range from Comfortable Seating to Full Seating

**Suggested Room Size:** Allows 56" to walk between wall and chair back, 32" to rise from table and 24" to walk

**Minimum Room Size:** Allows minimum of 48" wall to table to walk sideways between wall and chair back.

<u>Table Size</u>	<u>Seating Capacity</u>	<u>Suggested Room Size</u>	<u>Minimum Room Size</u>
72" (6') Long X 48" Wide	4-6	15' 4" X 13' 4"	14' X 12'
84" (7') Long X 48" Wide	4-6	16' 4" X 13' 4"	15' X 12'
96" (8') Long X 48" Wide	6-8	17' 4" X 13' 4"	16" X 12'
120" (10') Long X 48" Wide	8-10	19' 4" X 13' 4"	18' X 12'
144" (12') Long X 48" Wide	10-12	21' 4" X 13' 4"	20' X 12'
150" (12.5') Long X 48" Wide	10-12	21' 10" X 13' 4"	21' X 12'
168" (14') Long X 48" Wide	12-14	23' 4" X 13' 4"	22' X 12'
120" (10') Long X 58" Wide	8-10	19' 4" X 14' 2"	18' X 12' 10"
144" (12') Long X 58" Wide	10-12	21' 4" X 14' 2"	20' X 12' 10"
150" (12.5') Long X 58" Wide	10-12	22' 4" X 14' 2"	21' X 12' 10"
168" (14') Long X 58" Wide	12-14	23' 4" X 14' 2"	22' X 12' 10"
180" (15') Long X 58" Wide	12-14	24' 4" X 14' 2"	23' X 12' 10"
192" (16') Long X 58" Wide	14-16	25' 4" X 14' 2"	24' X 12' 10"
240" (20') Long X 58" Wide	18-20	29' 4" X 14' 2"	28' X 12' 10"
288" (24') Long X 58" Wide	22-24	33' 4" X 14' 2"	32' X 12' 10"

# Planning Information and Room Layouts

## Conference Room Typicals

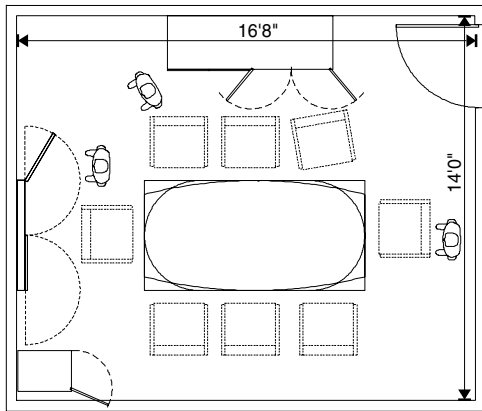

48" x 96" (8') Conference Table  
Seating for 6 to 8  
Minimum Room: 16'0" x 12'0"  
Preferred Room: 17'4" x 13'4"

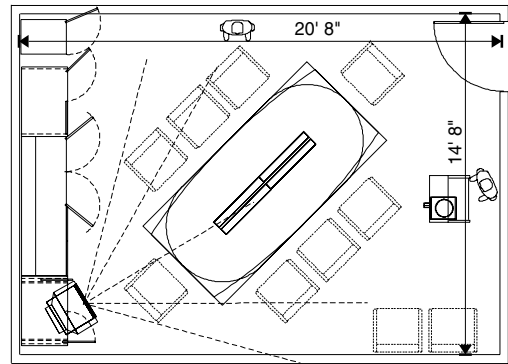

58" x 120" (10') ACT table  
Seating for 8 to 10  
Minimum Room: 18'0" x 12'10"  
Preferred Room: 19'4" x 14'2"

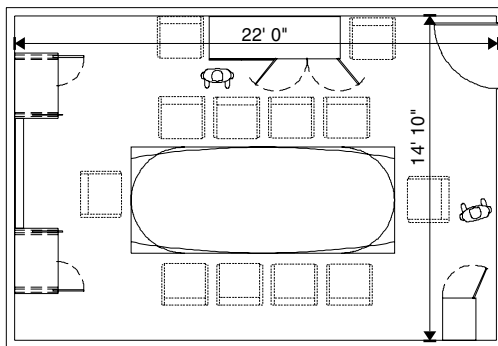

58" x 144" (12') Conference table  
Seating for 10 to 12  
Minimum Room: 20'0" x 12'10"  
Preferred Room: 21'4" x 14'2"

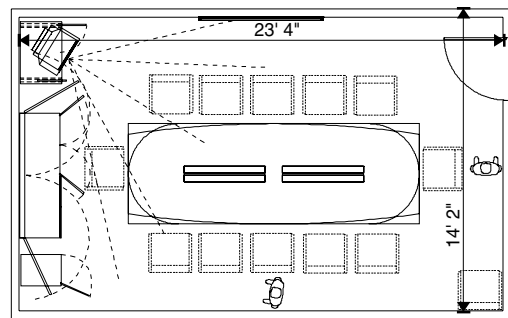

58" x 168" (14') ACT table  
Seating for 10 to 12  
Minimum Room: 22'0" x 12'10"  
Preferred Room: 23'4" x 14'2"

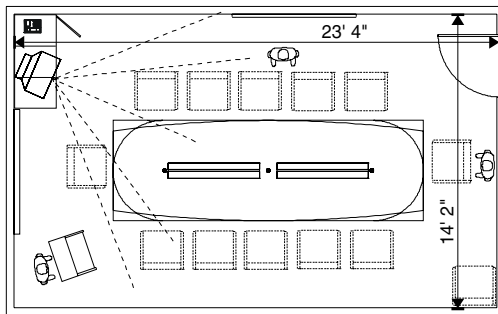

58" x 180" (15') ACT table  
Seating for 12 to 14  
Minimum Room: 23'0" x 12'10"  
Preferred Room: 24'4" x 14'2"

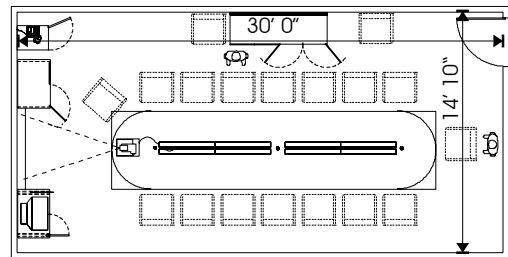

58" x 240" (20') Act Table  
Seating for 16 to 18  
Minimum Room: 28'0" x 12'10"  
Preferred Room: 29'4" x 14'2"



## Specifications - ACT and Kaizen WoodPlus Tables

### Product Overview

ACT Technology Tables and Kaizen Articulating Technology Tables accommodate power, voice and data needs through a center utility bay accessed beneath hinged doors in the top surface. The utility bay is easily customized to fit a client's needs. ACT and Kaizen tables are code sensitive with the ability to hard-wire connections to building sources. A qualified electrician is required. Tables are available in laminate with a variety of edge details including PVC, and various hardwood edges. Tables bases are laminate Radius Cube and Half Cylinder. All tables are shipped RTA (ready to assemble).

### SPECIFICATION HIGHLIGHTS

#### Laminate

All laminate components are available in Magna WoodPlus, WoodPlus XTRA, and ColorPlus finishes as well as many standard Pionite or WilsonArt laminates.

#### Hardwood Edge Banding

All hardwood edge material is select grade and is available in standard finishes. Lyptus wood is available for all hardwood edges on medium to dark finish colors. Lyptus grain pattern is similar to mahogany grain pattern.

#### Table Tops

All table tops use a three ply balanced construction which consists of an industrial board core surfaced with standard high-pressure laminate with plastic backing sheet .

Table top sections are tite-jointed together. Standard edges of PVC or hardwood are available per the Price List. Microphone grommets are available as options on the ACT and KAIZEN tables.

Leatherlam table tops are available, because of material considerations, please contact customer.

#### Special Top Laminates

Special Top Laminates are available on ACT tables. Please contact Customer Service for availability and upcharge.

#### Table Top Grain Direction

All wood grain laminate table tops have grain running along the length of the table.

#### Table top sections

Tables 120" (10') and shorter are built with one (1) piece tops.

Tables 144" (12') up to 240" (20') are built with two (2) piece tops.

144" (12') length tops can be built in one piece;

Tables over 240" (20') to 288" (24') are built with three (3) piece tops.

Leatherlam top: maximum length is 96" (8'), maximum width is 48" (4').

#### Table top End Grain Match

For multiple piece Laminate woodgrain tops (grain along the length of the table), the end grains will match as closely as possible.

#### Table Top Inlays

Table tops have optional inlays available that are set between the top laminate and the edge material. Inlays are available in Black PVC, Brushed Brass and Satin Chrome at 3mm wide (approximately 1/8") and require the use of the Detailed Wood, 2000 Wood or 3000 Wood edge.

#### Table Top Hinged Doors

Top hinged doors with 180° hinges allow access to utility bay. Doors are standard with 3mm edge and are available in all WoodPlus, WoodPlus XTRA, and ColorPlus finishes. These table top hinged door most often match the top finish color. Black brush grommet is standard full length of doors.

#### Utility Bay

Center Utility Bay is black laminate, and standard with wire manager and electrical outlets on each side of bay.

Wire manager is equipped with Faceplate Bezels and blank inserts; quantities based on size. Bezels and inserts are by PASS and SEYMOUR, available through electrical distributors nation-wide. Each bezel may house from 1 to 2 jacks and/or connectors depending on client specifications or requirements.

On the web, go to PASS and SEYMOUR website at [www.passandseymour.com/](http://www.passandseymour.com/) or check our webpage on inserts at [www.magnadesign.com/inserts.html](http://www.magnadesign.com/inserts.html).

Electrical outlets (15 AMP on a 20 AMP circuit) are installed on both sides of the bay; quantities based on size. All outlets are standard with two hardwired power entries (one for each side of bay) located at one end of the table. For power connection in the center table base, please see options.

Kaizen tables are powered only at the center base.  
Power and data remain connected even when table is reconfigured.

Please see ACT table overview pages for quantities and locations of electricals outlets and bezels.

#### Inserts for faceplate bezels

Bezels and inserts are by PASS and SEYMOUR, available through electrical distributors nation-wide. Each bezel may house from 1 to 2 jacks and/or connectors depending on client specifications or requirements.

On the web, go to PASS and SEYMOUR website at [www.passandseymour.com/](http://www.passandseymour.com/) or check our webpage on inserts at [www.magnadesign.com/inserts.html](http://www.magnadesign.com/inserts.html).

#### Table Bases

All Half Cylinder and Radius Cube bases are available in standard laminate to match or complement table tops. Radius Cube bases at table ends are 2/3 cube. One power access door in one of the end bases is included. Larger tables have center supports – full cylinder for half cylinder bases and full radius cube for radius cube bases. Additional power access doors are available as options.

## Specifications – WoodPlus Conference Products

### Conference Tables, Modular Tables, Cube and Drum Tables

Table tops are available in laminate with a variety of edge details including PVC and various hardwood edges. A variety of table bases are shown ranging from metal pedestal bases to laminate conference table bases. All tables are shipped RTA (ready to assemble). Cube and drum tables are available in laminate with a selection of edge details.

### SPECIFICATION HIGHLIGHTS

#### Laminate

All laminate components are available in Magna WoodPlus / Colorplus finishes as well as the new XTRA WoodPlus finishes and many standard Pionite / Panolam and WilsonArt laminates.

#### Hardwood

All hardwood edge material is select grade and is available in standard finishes. Lyptus wood is available for all hardwood edges on medium to dark finish colors. Lyptus grain pattern is similar to mahogany grain pattern.

#### Table Tops

All table tops use a three ply balanced construction which consists of an industrial board core surfaced with standard high-pressure laminate with plastic backing sheet. Fixed table top sections are tite-jointed together. Standard edges of PVC or hardwood are available per the price list.

Leatherlam table tops are available, because of material considerations, please contact customer.

#### Table Top Grain Direction

All wood grain laminate table tops have grain running along the length of the table.

#### Table top sections

Tables 120" (10') and shorter are built with one (1) piece tops.

Tables 144" (12') up to 240" (20') are built with two (2) piece tops.

144" (12') length tops can be built in one piece;

Tables over 240" (20') to 288" (24') are built with three (3) piece tops.

Leatherlam top: maximum length is 96" (8'), maximum width is 48" (4').

#### Table Top End Grain Match

For multiple piece Laminate woodgrain tops (grain along the length of the table), the end grains will match as closely as possible.

#### Table Top Inlays

Table tops have optional inlays available that are set between the top laminate and the edge material. Inlays are available in Black PVC, Brushed Brass and Satin Chrome at 3mm wide (approximately 1/8") and require the use of the Detailed Wood, 2000 Wood or 3000 Wood edge.

#### Cylinder, Radius Cube and Panel End Bases

All cylinder, half cylinder, cube and panel end bases are available in standard laminate to match or complement table tops. All half cylinder, full cylinder and radius cube bases are standard with metal stretchers when needed. Laminate Panel End bases come standard with a 3mm edge. Panel end bases include a matching 3/4 height stretcher between all end panels.

#### Metal Table Bases

Metal bases with rigid construction in various configurations are used for Modular and Mobile tables. Metal bases include round column legs (COL), T-leg (TLEG), 4 prong pedestal (COLX), 3 prong pedestal (COLT), T-leg with 2 vertical columns (TLEG2) and C-leg with wiremanager (CLEG-WM). Bases are finished with Black or Silver Powder Coat.

#### Slide table bases

SLIDE table is available with two different bases. The 'EC' are available with levelers, casters or a combination of levelers and casters. Finish is Silver. The 'ARCT' base includes a flip top with single release handle, available in silver or black.

#### Cube and Drum Tables

All cube and drum tables are offered in laminate with 1 3/4" tops and PVC or solid hardwood edges. Detailed edges use solid hardwood edges on the top to match Modular 8.

#### Adjustable Glides

All table bases except Cube and Drum tables have adjustable glides.

#### Credenza Cabinets

Cabinet case is finished on all exposed surfaces with the cabinet back inset between the case tops and sides. All doors, cabinet case sides and back are 3/4" thick. Doors and cabinet sides and backs are constructed with vertical grain patterns or are solid ColorPlus finish. Credenza top with wood edge to match the conference room table wood edge is now available for all wood edges and inlays. Open credenza with single row of drawers is also available for use between storage towers.

#### Pulls

Pulls #10, #12, #13, #14, #15, #18 and #19 for drawer fronts, hinged doors, recycle bins.

Pull #21 is available at an upcharge per pull.

ACT and Kaizen table top doors and BHD Base Hinged Doors do not have pulls.

#### Locks

Locks are available on hinged doors as an option. Removable lock cylinders provide for keying alike or re-keying in the field.

## Specifications – ACT WoodPlus<sup>2</sup> Tables

### WoodPlus<sup>2</sup> Conference Product Specifications

#### Product Overview

WoodPlus<sup>2</sup> Conference products consist of ACT (ACessing Technology) Tables, Conference Tables and Conference Credenzas along with Presentation accessories including Visual Display boards and framed White Boards. WoodPlus<sup>2</sup> tables are a maximum of 46" wide and 168" long. Top shapes are Bow Ended Rectangle or Boat, Racetrack, Wedge and Egg. ACT Table bases are Half Cylinder, Radius Half Cylinder or Radius Cube bases. Credenzas are offered in Door Storage or Recycling configurations.

#### SPECIFICATION HIGHLIGHTS

All exposed surfaces shall be Magna WoodPlus<sup>2</sup> / ColorPlus<sup>2</sup> laminates. Standard finishes shall include WoodPlus<sup>2</sup> wood grain patterns, ColorPlus<sup>2</sup> speckle patterns and ColorPlus<sup>2</sup> solid colors as described in the finishes section. XTRA WoodPlus<sup>2</sup> / ColorPlus<sup>2</sup> finishes are also available as described in the finishes section.

#### WoodPlus<sup>2</sup> ACT Technology tables

ACT (Accessing Technology) Tables accommodate power, voice and data needs through a center utility bay accessed beneath hinged doors in the top surface. The utility bay is easily customized to fit a client's needs. ACT tables are also code sensitive with the ability to hard-wire connections to building sources (qualified electrician required). All tables are shipped RTA (ready to assemble).

#### Tops

All WoodPlus<sup>2</sup> tops are 1-1/8" thick with a formed edge. WoodPlus<sup>2</sup> top construction consists of a 48 LB MDF core surfaced with rigid thermoformed polymer-based decorative composite sheet and a balancing backer sheet. ACT table tops include microphone grommets; see Price Catalog for quantity per table size.

#### Table Top Grain Direction

WoodPlus<sup>2</sup> ACT and Conference tables are standard with grain running the length of the table.

#### Table Top End Grain Match

For multiple piece woodgrain tops, the end grains will match as closely as possible.

#### Edges

WoodPlus<sup>2</sup> / ColorPlus<sup>2</sup> horizontal and vertical surfaces come with rounded, soft edges that are a seamless and integrated part of the surface.

#### Table Top Hinged Doors

Top hinged doors with 180° hinges allow full access to utility bay and match the top finish. Doors have a formed integral edge. Brush grommet is standard full length of doors.

#### Utility Bay

Center Utility Bay is black laminate, and standard with wire manager and electrical outlets on each side of bay.

Wire manager is equipped with Faceplate Bezels and blank inserts; quantities based on size. Bezels and inserts are by PASS and SEYMOUR, available through electrical distributors nation-wide. Each bezel may house from 1 to 2 jacks and/or connectors depending on client specifications or requirements.

On the web, go to PASS and SEYMOUR website at [www.passandseymour.com/](http://www.passandseymour.com/) or check our webpage on inserts at [www.magnadesign.com/inserts.html](http://www.magnadesign.com/inserts.html).

Electrical outlets (15 AMP on a 20 AMP circuit) are installed on both sides of the bay; quantities based on size. All outlets are standard with two hardwired power entries (one for each side of bay) located at one end of the table. For power connection in the center table base, please see options.

Please see ACT table overview pages for quantities and locations of electricals outlets and face plate bezels.

Inserts for faceplate bezels

Bezels and inserts are by PASS and SEYMOUR, available through electrical distributors nation-wide. Each bezel may house from 1 to 2 jacks and/or connectors depending on client specifications or requirements.

On the web, go to PASS and SEYMOUR website at [www.passandseymour.com/](http://www.passandseymour.com/) or check our webpage on inserts at [www.magnadesign.com/inserts.html](http://www.magnadesign.com/inserts.html).

#### Half Cylinder and Radius Cube Table Bases

All half cylinder and radius cube bases are available in standard WoodPlus<sup>2</sup> woodgrain and ColorPlus<sup>2</sup> finishes. See finish section for available finishes. Radius Cube bases at table ends are 2/3 cube. Half Cylinder and Radius Cube bases have one power access door (hinged door in one of the bases at the table end). Larger tables have center supports – full cylinder for half cylinder bases and full radius cube for radius cube bases. Additional power access doors (hinged door in base at end of table) are available as options.

#### Adjustable Glides

All table bases have adjustable glides.

## Specifications – WoodPlus<sup>2</sup> Conference Products

### WoodPlus<sup>2</sup> Conference and Modular Tables

#### Tops

All WoodPlus2 tops are 1-1/8" thick with a formed edge. WoodPlus2 top construction consists of a 48 LB MDF core surfaced with rigid thermoformed polymer-based decorative composite sheet and a balancing backer sheet.

#### Table Top Grain Direction

WoodPlus2 ACT and Conference tables are standard with grain running the length of the table.

#### Edges

WoodPlus2 / ColorPlus2 horizontal and vertical surfaces come with rounded, soft edges that are a seamless and integrated part of the surface.

#### Cylinder, Half Cylinder and Radius Cube Table Bases

All cylinder, half cylinder and radius Cube bases are available in standard WoodPlus2 woodgrain or ColorPlus2 finishes. Metal stretchers are provided with half cylinder and radius cube bases as needed to support top. Larger tables have center supports – full cylinder for half cylinder bases and full radius cube for radius cube end bases. The radius cube end bases are 2/3 the 'length' of a center radius cube.

#### Slide table bases

SLIDE table is available with two different bases. The 'EC' are available with levelers, casters or a combination of levelers and casters. Finish is Silver. The 'ARCT' base includes a flip top with single release handle, available in silver or black.

#### COL Column bases

Metal base with columns uses rigid construction and is finished with Black or Silver Powder Coat.

#### Adjustable Glides

All table bases have adjustable glides.

#### Wire Management

Optional Grommets and wire managers are available. Finish is satin black.

### WoodPlus2 Credenzas

#### Tops

All WoodPlus2 tops are 1-1/8" thick with a formed edge. WoodPlus2 top construction consists of a 48 LB MDF core surfaced with rigid thermoformed polymer-based decorative composite sheet and a balancing backer sheet.

#### Edges

WoodPlus2 / ColorPlus2 horizontal and vertical surfaces come with rounded, soft edges that are a seamless and integrated part of the surface.

#### Credenza Cabinets

Cabinet case is finished on all exposed surfaces with the cabinet back inset between the case tops and sides. All doors, cabinet case sides and back are 3/4" thick. Vertical grain on the doors, drawer faces, backs and sides.

#### Pulls

Pulls #10, #12, #13, #14, #15, #18 and #19 are available at no extra charge. Pull #21 is available at an upcharge per pull.

#### Locks

Locks are available on hinged doors as an option. Removable lock cylinders provide for keying alike or re-keying in the field.

#### Finishes

WoodPlus2, XTRA WoodPlus2, ColorPlus2 and XTRA ColorPlus2 polymer finishes with formed edges.

WoodPlus2, XTRA WoodPlus2, ColorPlus2 and XTRA ColorPlus2 components are manufactured using thermoformed polymer based, decorative composite sheets in wood grain, speckle and solid patterns. The result is a seamless component; work surface, table top, drawer or door face with exceptional wear and appearance characteristics.

#### Cleaning and Care

WoodPlus2, XTRA WoodPlus2, ColorPlus2 and XTRA ColorPlus2 may be cleaned with mild cleaning agents that contain no bleach or bleach substitutes. Under no circumstances can acetone or polish remover be used to clean any of the surfaces. Using it will void the warranty on the product and can do considerable damage to the surface.

# Finishes - ACT Conference and Modular Table Finishes

## Table Top Finishes

## Table edge finishes

### WoodPlus and WoodPlus XTRA Finishes

#### WoodPlus Colors

WP-41 Natural Maple  
 WP-81 Fusion Maple  
 WP-45 Anigre  
 WP-04 Solar Oak  
 WP-61 Pear  
 WP-31 Medium Cherry  
 WP-71 Dark Cherry  
 WP-73 Cognac  
 WP-48 Sipping Seattle Java - 1  
 WP-23 Cordovan

#### WoodPlus XTRA colors

WP-05 Rift Oak  
 WP-15 Midnight - 1  
 WP-35 Golden Cherry  
 WP-33 Blossom Cherry - 2  
 WP-75 Chestnut  
 WP-37 Mocha Cherry  
 WP-67 Chocolate Pear

#### Upcharge of \$600 per XTRA finish per order

- 1 - Hi-Brite texture on table tops and worksurfaces  
All other surfaces are suede texture.
- 2 - Hi-Lustre texture on table tops and worksurfaces.  
All other surfaces are suede texture.

Additional finishes (about 100) from Pionite / Panolam line of woodgrain, solid and patterned laminates are available.

See our website for currently available finishes  
[www.magnadesign.com/products/finishes/finishes-added.htm](http://www.magnadesign.com/products/finishes/finishes-added.htm)

#### Edges:

- WoodPlus PVC edges in a complimentary or contrasting color
- Hardwood to match available for a one time charge of \$268 List

Leadtime is four to six weeks.

Please contact Customer Service at 800-233-2304 for details and pricing.

#### Leatherlam top finishes

Available in five standard Leatherlam finishes:  
 Caviar, Chocolate, Bordeaux, Cashmere, Oasis.  
 Minimum upcharge is \$860 per 4' x 8' top piece.  
 Contact customer service for actual upcharge required.

#### Special Top Laminates

WilsonArt standard laminates  
 Pionite standard laminates

Please check with customer service for acceptability of other special top laminates.  
 Upcharge for each special top laminate is \$150 per finish per order.

Special Top Laminates must meet the following criteria:  
 Dark solid colors, including Black,  
 NOT available for tops  
 Available in 5 x 12 sheets (horizontal grade)

and

available in 4 x 8 sheets (vertical grade).  
 Acceptable texture is suede or Hi-Brite.  
 Glossy, Chemsurf finishes are not acceptable.  
 Acceptable texture compatible with applied edges.

\*\*\*\*\*  
**ACT Table doors in special top laminate \$600 LIST**

#### 3 mm PVC , WoodPlus Edge

**1-3/4" thick tops: WPMS, WPMN, WPMR,**  
**1-1/8" thick tops: WPES, WPEN, WPER**

WP-41 Natural Maple  
 WP-81 Fusion Maple  
 WP-45 Anigre  
 WP-04 Solar Oak  
 WP-05 Rift Oak  
 WP-61 Pear  
 WP-33 Blossom Cherry  
 WP-73 Cognac  
 WP-48 Sipping Seattle Java  
 WP-75 Chestnut  
 WP-31 Medium Cherry  
 WP-71 Dark Cherry  
 WP-23 Cordovan  
 CP-88 Black

#### Finishes for Hardwood edges:

**1-3/4" thick tops: SWMS, SWMN, SWMR,**  
**1-1/8" thick tops: SWES, SWEN, SWER,**

**RA. BE. TR. RE. CL,**

**1000. 1100, 1200.**

**2000, 2001, 2002, 2003, 2004. 2100. 2200,**  
**3200, 3300, 3400 (as available)**

W-04 Solar Oak  
 W-15 Midnight  
 W-23 Cordovan  
 W-31 Medium Cherry  
 W-33 Blossom Cherry  
 W-35 Golden Cherry  
 W-41 Natural Maple  
 W-45 Anigre (color match only)  
 W-48 Sipping Seattle Java (color match only)  
 W-61 Pear  
 W-71 Dark Cherry  
 W-73 Cognac  
 W-75 Chestnut  
 W-81 Fusion Maple (color match only)

#### Lyptus Hardwood edges

Available for all wood edges listed above:  
 SWES, SWEN, SWER, SWMS, SWMN, SWMR,  
 RA. BE. TR. RE. CL,  
 1000. 1100, 1200.  
 2000, 2001, 2002, 2003, 2004. 2100. 2200,  
 3200, 3300, 3400 (as available)

Please use the price shown for the wood edge being ordered. No upcharge for Lyptus wood edge.  
 Grain is similar to a mahogany grain pattern.  
 Available in a medium to dark finish color.

Lyptus is a hardwood grown in sustainable forests which matures in about 15 years rather than the 70 or more years required for mahogany and other hardwoods. After harvesting, Lyptus regrows using the same roots and will be ready for harvesting in about 15 years.

\*\*\*\*\*

## Finishes - ACT Conference Modular Table Finishes

### Table Base

### Vertical finishes (other than Table Top)

**CYL (Cylinder), HC, RHC (Half Cylinder),  
RC (Radius Cube), PEB (Panel End Base)**

**Credenzas, Storage Towers,  
Video Towers, Mobile Units**

WP-04 Solar Oak  
 WP-05 Rift Oak (XTRA)  
 WP-15 Midnight - 1 (XTRA)  
 WP-23 Cordovan  
 WP-31 Medium Cherry  
 WP-33 Blossom Cherry - 2 (XTRA)  
 WP-35 Golden Cherry (XTRA)  
 WP-37 Mocha Cherry (XTRA)  
 WP-41 Natural Maple  
 WP-45 Anigre  
 WP-48 Sipping Seattle Java - 1 (XTRA)  
 WP-61 Pear  
 WP-67 Chocolate Pear (XTRA)  
 WP-71 Dark Cherry  
 WP-73 Cognac  
 WP-75 Chestnut (XTRA)  
 WP-81 Fusion Maple  
 CP-76 Espresso  
 CP-88 Black  
 CP-98 Slate

WP-04 Solar Oak  
 WP-05 Rift Oak (XTRA)  
 WP-15 Midnight (XTRA)  
 WP-23 Cordovan  
 WP-31 Medium Cherry  
 WP-33 Blossom Cherry - 2 (XTRA)  
 WP-35 Golden Cherry (XTRA)  
 WP-37 Mocha Cherry (XTRA)  
 WP-41 Natural Maple  
 WP-45 Anigre  
 WP-48 Sipping Seattle Java - 1 (XTRA)  
 WP-61 Pear  
 WP-67 Chocolate Pear (XTRA)  
 WP-71 Dark Cherry  
 WP-73 Cognac  
 WP-75 Chestnut (XTRA)  
 WP-81 Fusion Maple  
 CP-76 Espresso  
 CP-88 Black  
 CP-98 Slate

- 1 - Table tops have Hi-Brite texture while table bases have suede texture
- 2 - Table tops have Hi-Lustre texture while table bases have suede texture

- 1 - Panel End base finishes are suede texture

WilsonArt standard laminates  
 Pionite standard laminates

ONLY if Available as 'vertical grade' laminate

\*\*\*\*\*

---

### WoodPlus2 and WoodPlus2 XTRA Finishes

#### WoodPlus2 tops, doors, drawer faces

#### WoodPlus2 verticals

(other than doors, drawer faces)

WP2-23 Cordovan  
 WP2-31 Medium Cherry  
 WP2-41 Natural Maple  
 WP2-45 Anigre  
 WP2-61 Pear  
 WP2-71 Dark Cherry  
 WP2-81 Fusion Maple  
 CP2 -28 Med Grey Speckle  
 CP2-38 Beige Speckle.

WP2-23 Cordovan  
 WP2-31 Medium Cherry  
 WP2-41 Natural Maple  
 WP2-45 Anigre  
 WP2-61 Pear  
 WP2-71 Dark Cherry  
 WP2-81 Fusion Maple  
 CP2-76 Espresso  
 CP2-98 Slate  
 CP2-88 Black

#### WoodPlus2 XTRA tops only

WP2-18 Shadow Oak  
 WP2-65 Beech  
 CP2-72 Shark Gray  
 CP2-74 Platinum  
 CP2-78 Bronze  
 CP2-80 Cashmere Fiber

Upcharge of \$600 per XTRA finish per order

\*\*\*\*\*

---

#### Metal Bases

**COL, COLX, COLT, CLEG, TLEG, TLEG2**

Black or Silver Powder Coat

**Specifications subject to change without notice**

# ACT Table Overview

## Overview - ACT Tables

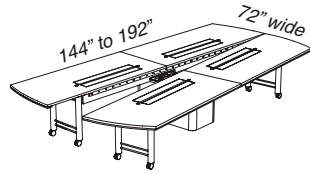

'ACT Kaizen articulating table," on page 34

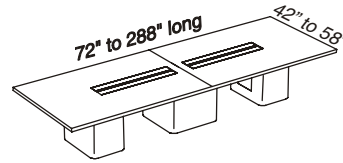

'Rectangular ACT - Radius Cube Base," on page 38

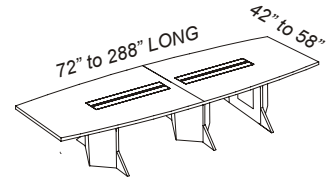

'Arrow ACT - Triangle Base," on page 37

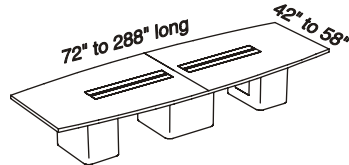

'Boat Shape ACT - Radius Cube Base," on page 40

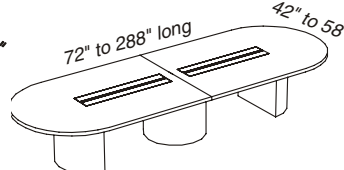

'Racetrack ACT - Half Cylinder Base," on page 42

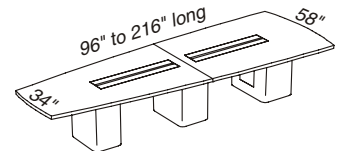

'Racetrack ACT - with Narrow Half Cylinder Base," on page 43

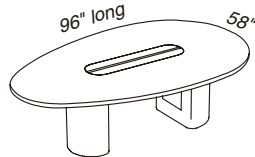

'Egg Shape ACT - Radius Half Cylinder Base," on page 44

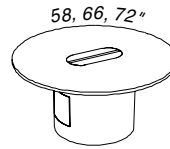

'Delta ACT - Radius Cube Base," on page 44

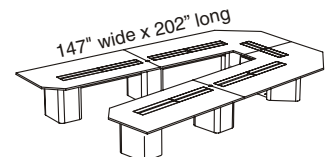

'ACT WING table," on page 46

## Overview - ACT WoodPlus2 Tables

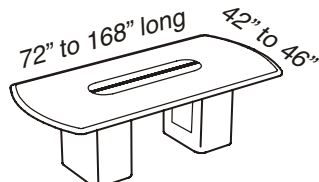

'ACT WoodPlus2 Boat Bow End with Radius Cube Base," on page 48

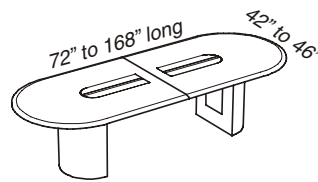

'ACT WoodPlus2 Racetrack with Half Cylinder Base," on page 49

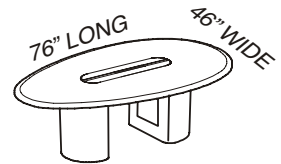

'ACT WoodPlus2 'Egg' with Radius Half Cylinder Base," on page 49

## Overview - ACT Base Hinged Door, Brush Grommet details

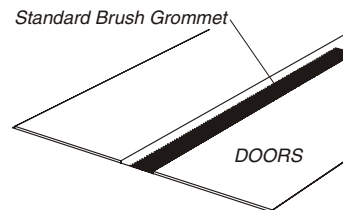
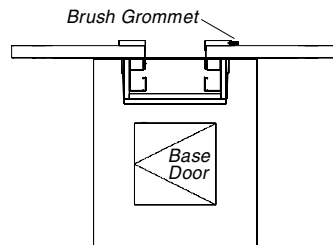

# ACT Table Overview

## Overview - ACT Table Shapes

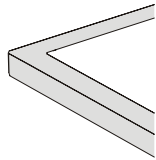

Standard eased Corner

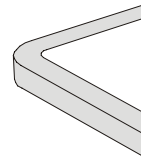

C3R -3" Radius Corner Option

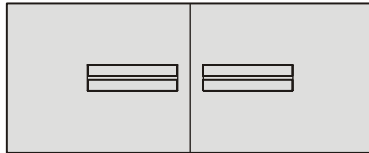

Rectangular - 58 x 150

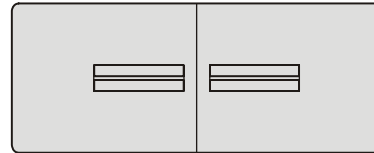

Rectangular - 58 x 150 with C3R

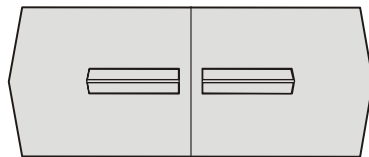

Arrow - 58 x 150

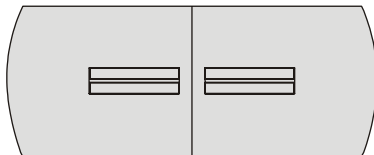

Rectangular with Bow End option - 58 x 150

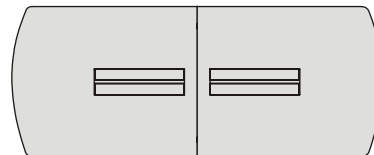

Rectangular Bow End & C3R - 58 x 150

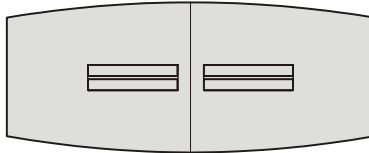

Boat Shape - 58 x 150

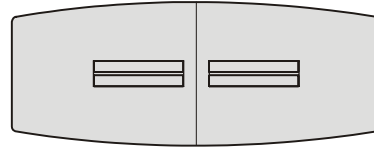

Boat Shape - 58 x 150 with C3R

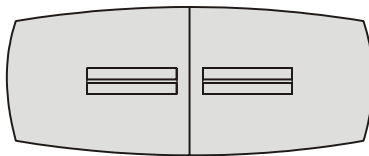

Boat Shape - 58 x 150 with Bow End Option

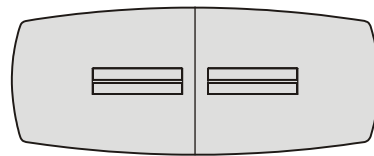

Bow End Boat Shape - 58 x 150 with C3R

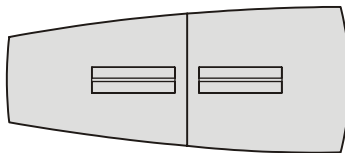

Delta Shape - 58 x 144

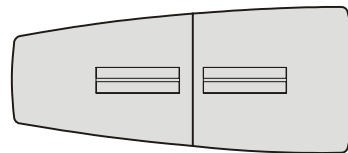

Delta Shape - 58 x 144 with C3R

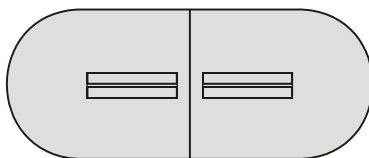

Racetrack Shape - 58 x 150

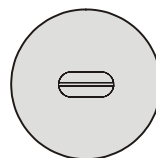

Round Shape - 58" diameter

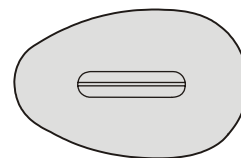

"Egg" Shape - 58 x 96



# ACT Table Overview

## Overview - ACT Top Door and Base Configurations

42" - 48" wide Tables

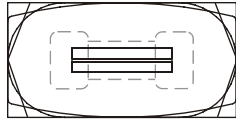

Table sizes: 42 and 48" wide  
72, 84 and 96" long  
Single pair of Access doors

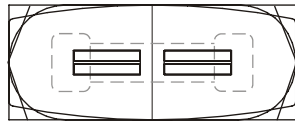

Table size: 42 and 48" wide and 120" long  
Two pair of Access doors

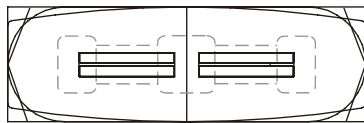

Table sizes: 42 and 48" wide 144 and 150" long  
Two pair of Access doors, and center base

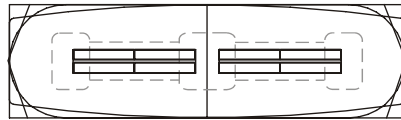

Table size: 42 and 48" wide and 168" long  
Four pair of Access doors, center base

58" Wide Tables

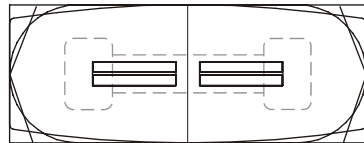

Table sizes: 58120, 58144 and 58150  
Two pair of Access doors

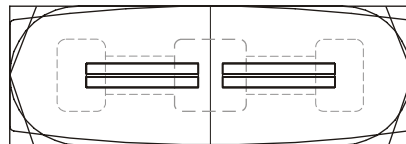

Table size: 58168  
Two pair of Access doors, and center base

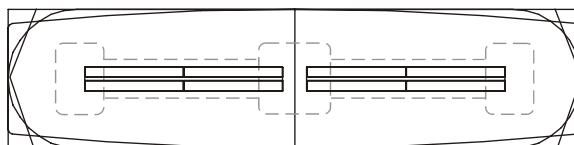

Table sizes: 58180, 58192, 58216 and 58240  
Four pair of Access doors, center base

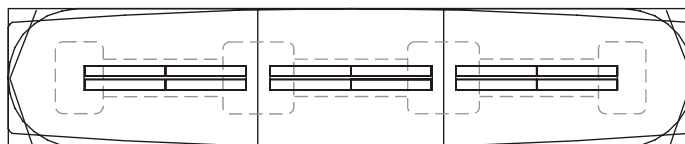

Table size: 58288  
Six pair of Access doors, two center bases

58" Wide Egg Shape Table

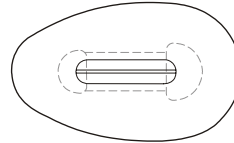

Table size: 5896  
Single pair of Access doors

58" Wide Delta Shape Tables

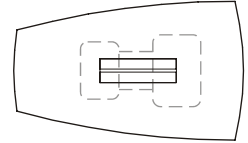

Table size: 5896 and 58120  
Single pair of Access doors

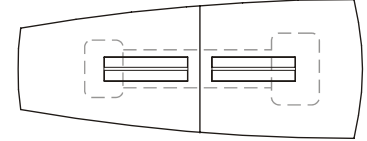

Table sizes: 58144 and 58150  
Two pair of Access doors

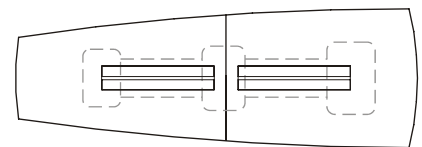

Table size: 58168  
Two pair of Access doors, Center base

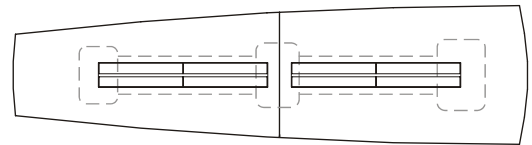

Table sizes: 58192 and 58216  
Four pair of Access doors, Center base

Round Tables

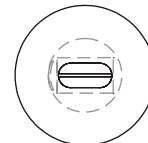

Table size: 58" diameter  
Single pair of Access doors

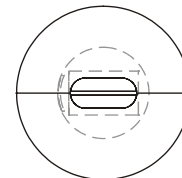

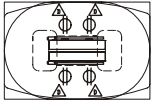
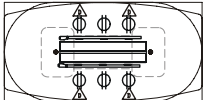
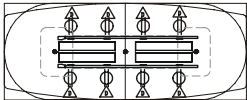
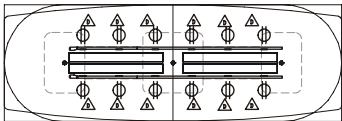
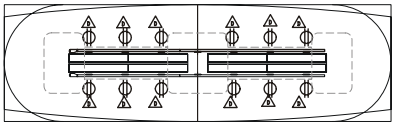
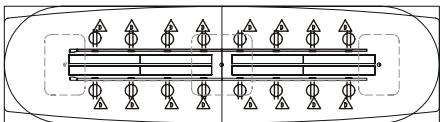
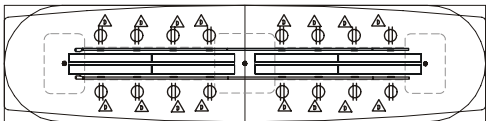
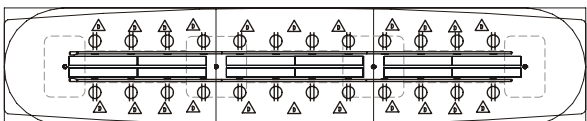
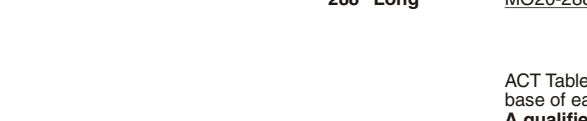

Table size: 66 and 72" diameter,  
2 piece top,  
Single pair of Access doors

# ACT Table Overview

## Overview - ACT Table MO20 Electrical Packages

	Description	Model Number	Duplexes	Outlets Total	Face Plate Bezels	Microphone Grommets	Seating Capacity
	<b>Electrical Package</b>						
	<b>58, 66 or 72" Round</b>	MO20-58D	2	4	2	None	5
		MO20-66D	4	8	4	None	6
		MO20-72D	4	8	4	None	6
	<b>72" Long Table</b>	MO20-72	4	8	4	None	6
	<b>84" Long</b>	MO20-84	4	8	4	None	6
	<b>96" Long</b>	MO20-96	6	12	4	2 - optional	6-8
	<b>120" Long</b>	MO20-120	8	16	8	3 - optional	8-10
	<b>144" Long</b>	MO20-144	8	16	8	3 - optional	8-10
	<b>150" Long</b>	MO20-150	8	16	8	3 - optional	8-10
	<b>168" Long</b>	MO20-168	12	24	12	3 - optional	10-12
	<b>180" Long</b>	MO20-180	12	24	12	3 - optional	10-12
	<b>192" Long</b>	MO20-192	12	24	12	3 - optional	12-14
	<b>216" Long</b>	MO20-216	16	32	16	3 - optional	14-16
	<b>240" Long</b>	MO20-240	16	32	16	3 - optional	16-18
	<b>288" Long</b>	MO20-288	24	48	20	4 - optional	20-22

ACT Tables are equipped with two Power Entry cables and a Base Hinged Door (BHD) at one end base of each table. For Delta or Egg table, the large end will be used.  
**A qualified electrician is required to hardwire the power cable to the floor connection.**

# ACT Table Overview

## Overview - ACT Table MO20 Electrical Details

### Electrical connection:

ACT Tables are equipped with two Power Entry cables and a Base Hinged Door (BHD) at one end of each table.

For Delta and Egg tables, the large end will be used

**A qualified electrician is required to hardwire the power cable to the floor connection.**

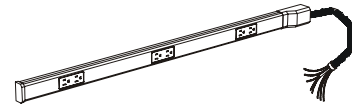

MO20-96 (for 96" long table) includes 2 each of unit shown- 3 duplex each side of utility bay and Hardwire (not plug-in) Power Entry

Table Size	Outlets	Faceplate Bezels
60 dia	2 duplex	2 bezels
72/84	4 duplex	4 bezels
96	6 duplex	4 bezels
120	8 duplex	8 bezels
144	8 duplex	8 bezels
150	8 duplex	8 bezels
168	12 duplex	8 bezels
180	12 duplex	12 bezels
192	12 duplex	12 bezels
216	16 duplex	16 bezels
240	16 duplex	16 bezels
288	24 duplex	20 bezels

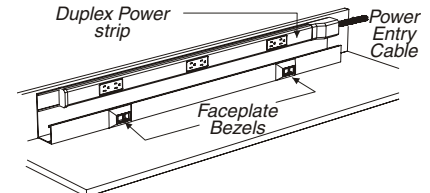

Complete electrical and data access assembly in utility bay (view of one side). Shipped with pigtail ready for hardwiring.

Each Bezel holds one 2A insert

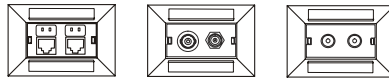

Bezels 2A with inserts

Faceplate Bezels are supplied with a BLANK 2A filler insert.

### Insert Information:

Inserts fit into the Bezel supplied with ACT tables, and are available from any national electrical supplier.

Pass and Seymour manufactures the Bezels used in our ACT tables.

ACT tables are shipped with Blank inserts.

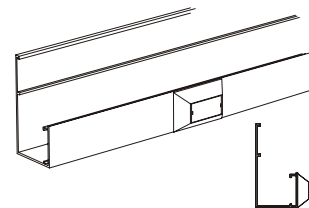

ACT Tables include Wire management and Faceplate Bezels with blank 2A inserts

## ACT Table Overview

### Optional Plug end electrical for ACT tables

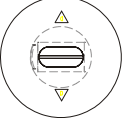
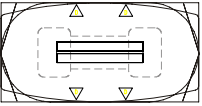
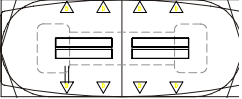
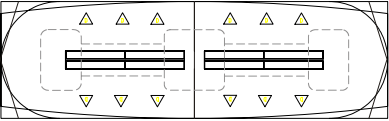
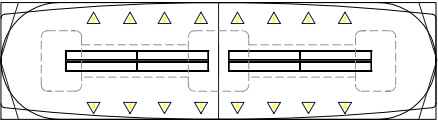
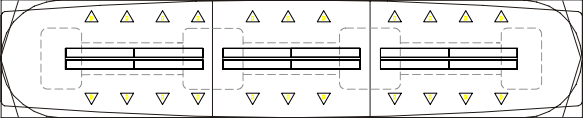
	Table length	Duplexes	Qty	Plug end model	List Price add	Notes
	58 dia	4	2	AC-PLUG-2-24	250	
	66 dia	4	2	AC-PLUG-2-24	250	
	72 dia	4	2	AC-PLUG-2-24	250	
	72	6	2	AC-PLUG-3-36	250	
	84	6	2	AC-PLUG-3-36	250	
	96	6	2	AC-PLUG-3-36	250	
	120	10	2	AC-PLUG-5-60	250	Includes 2nd BHD base hinged door, for one at each end of table, or includes BHD in center with access added to utility bay.
	144	12	4	AC-PLUG-3-36	645	
	150	12	4	AC-PLUG-3-36	645	
	168	12	4	AC-PLUG-3-36	645	Includes 2nd BHD base hinged door, for one at each end of table, or includes BHD in center with access added to utility bay.
	180	16	4	AC-PLUG-4-48	805	
	192	16	4	AC-PLUG-4-48	805	
	216	20	4	AC-PLUG-5-60	805	Includes 2nd BHD base hinged door, for one at each end of table, or includes BHD in center with access added to utility bay.
	240	24	4	AC-PLUG-6-72	945	
	288	24	6	AC-PLUG-4-48	1058	Includes 2nd BHD base hinged door, one at each base in the center of table and access from the utility bay to the center bases.

Plug end powerstrips are UL labeled, 15 Amp with 6' long cord.

AC-PLUG-2-24 has two outlets and is 24" long.

AC-PLUG-3-36 has three outlets and is 36" long.

AC-PLUG-4-48 has four outlets and is 48" long.

AC-PLUG-5-60 has five outlets and is 60" long.

AC-PLUG-6-72 has six outlets and is 72" long.

## ACT Table Overview

### Boat TB shaped top table base information

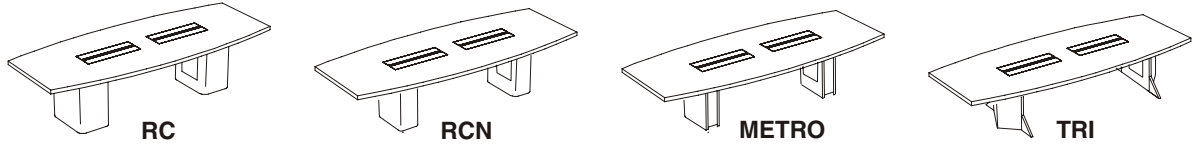

Wide	Long	(A)	RC base (C)				RCN base (C)				METRO base (C)				TRI base (C)			
			MLC	Qty	End	Center	IFE	Qty	End	Center	IFE	Qty	End	Center	IFE	Qty	End	Center
42	72	20	2	9x18		14	2	8x18		15	2	6x18		16	2	8x30		14
42	84	24	2	9x18		18	2	8x18		20	2	6x18		18	2	8x30		18
42	96	24	2	12x18		18	2	8x18		20	2	6x18		18	2	8x30		20
42	120	24	2	12x18		18	2	8x18		20	2	6x18		18	2	8x30		20
42	144	24	3	12x16	18x18	18	3	8x16	12x18	20	3	6x16	8x18	18	3	8x30	15x30	20
42	150	24	3	12x16	18x18	18	3	8x16	12x18	20	3	6x16	8x18	18	3	8x30	15x30	20
42	168	24	3	12x16	18x18	18	3	8x16	12x18	20	3	6x16	8x18	18	3	8x30	15x30	20
46	72	25	2	14x20		18	2	8x20		21	2	6x20		22	2	8x30		21
46	84	25	2	14x20		18	2	8x20		21	2	6x20		22	2	8x30		21
46	96	25	2	14x20		18	2	8x20		21	2	6x20		22	2	8x30		21
46	120	25	2	14x20		18	2	8x20		21	2	6x20		22	2	8x30		21
46	144	25	3	14x18	20x20	18	3	8x18	14x20	21	3	6x20	8x20	22	3	8x30	15x30	21
46	150	25	3	14x18	20x20	18	3	8x18	14x20	21	3	6x20	8x20	22	3	8x30	15x30	21
46	168	25	3	14x18	20x20	18	3	8x18	14x20	21	3	6x20	8x20	22	3	8x30	15x30	21
48	72	20	2	12x22		14	2	8x22		15	2	6x22		16	2	8x30		18
48	84	24	2	12x22		18	2	8x22		20	2	6x22		18	2	8x30		18
48	96	24	2	12x22		18	2	8x22		20	2	6x22		18	2	8x30		18
48	120	24	2	16x22		18	2	8x22		20	2	6x22		18	2	8x30		18
48	144	24	3	14x20	24x24	18	3	8x20	14x24	20	3	6x20	8x24	18	3	8x30	15x30	18
48	150	24	3	14x20	24x24	18	3	8x20	14x24	20	3	6x20	8x24	18	3	8x30	15x30	18
48	168	24	3	14x20	24x24	18	3	8x20	14x24	20	3	6x20	8x24	18	3	8x30	15x30	18
58	120	26	2	20x28		20	2	8x28		22	2	6x28		20	2	12x34		24
58	144	26	2	20x28		20	3	8x24	16x30	22	3	6x24	8x30	20	2	12x34		24
58	150	26	2	20x28		20	3	8x24	16x30	22	3	6x24	8x30	20	2	12x34		24
58	168	26	3	16x24	30x30	20	3	8x24	16x30	22	3	6x24	8x30	20	3	12x34	22x34	24
58	180	26	3	16x24	30x30	20	3	8x24	16x30	22	3	6x24	8x30	20	3	12x34	22x34	24
58	192	26	3	16x24	30x30	20	3	8x24	16x30	22	3	6x24	8x30	20	3	12x34	22x34	24
58	216	28	3	16x24	30x30	20	3	8x24	16x30	24	3	6x24	8x30	24	3	12x34	22x34	24
58	240	28	3	16x24	30x30	20	3	8x24	16x30	24	3	6x24	8x30	24	3	12x34	22x34	24
58	288	28(B)	4	16x24	30x30	20	4	8x24	16x30	24	4	6x24	8x30	24	4	12x34	22x34	24

(A) - MLC - center of the monument locaton is this distance from the end of the table

(B) - MLC - center base monument locaton is 104" or 8' 8" from the end of the table

(C) - IFE - Inset From End - how far is the base from the end of the table

Monument cutout for

RC Radius Cube and RCN Radius Cube Narrow bases is 6" less in each dimension. Exception for RC or RCN bases 8" or 9" long.

METRO bases at 6" wide is 3.75", at 8" wide is 5.75". For length, deduct 4" from the length of the base.

TRI end bases at 28 long, opening is 5" diameter, TRI center bases at 28" long, opening is 7".

TRI end bases at 34 long, opening is 7" diameter, TRI center bases at 34" long, opening is 7".

# ACT Table Overview

## Boat TB shaped top table base information

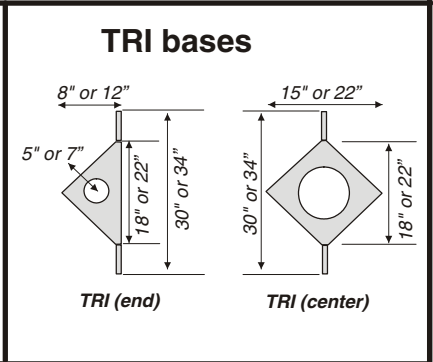
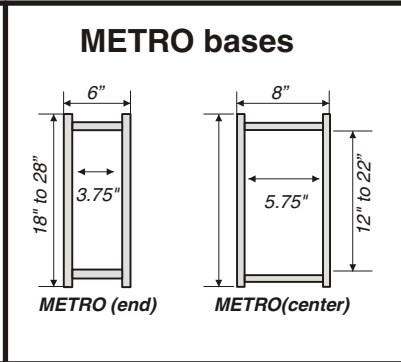
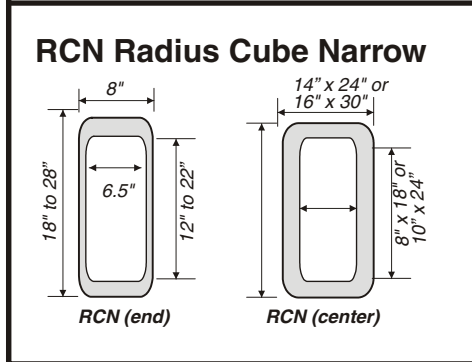
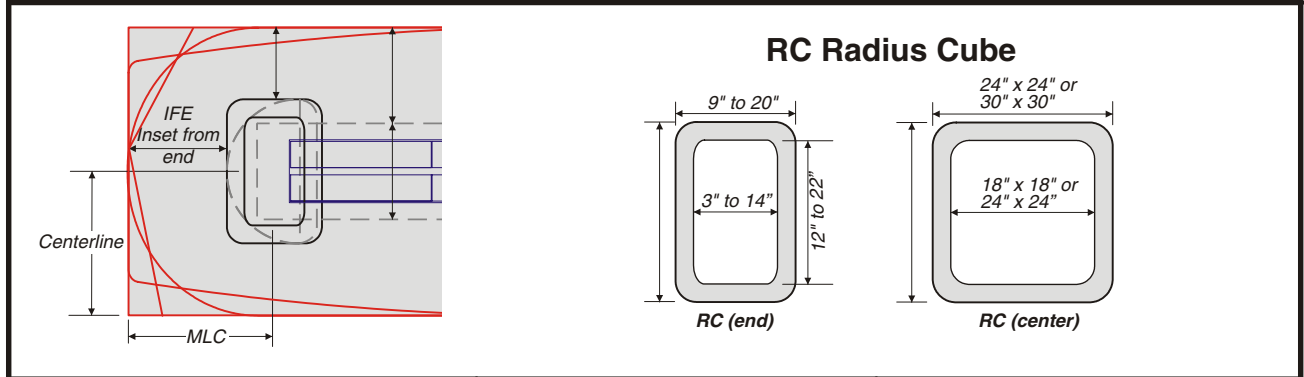
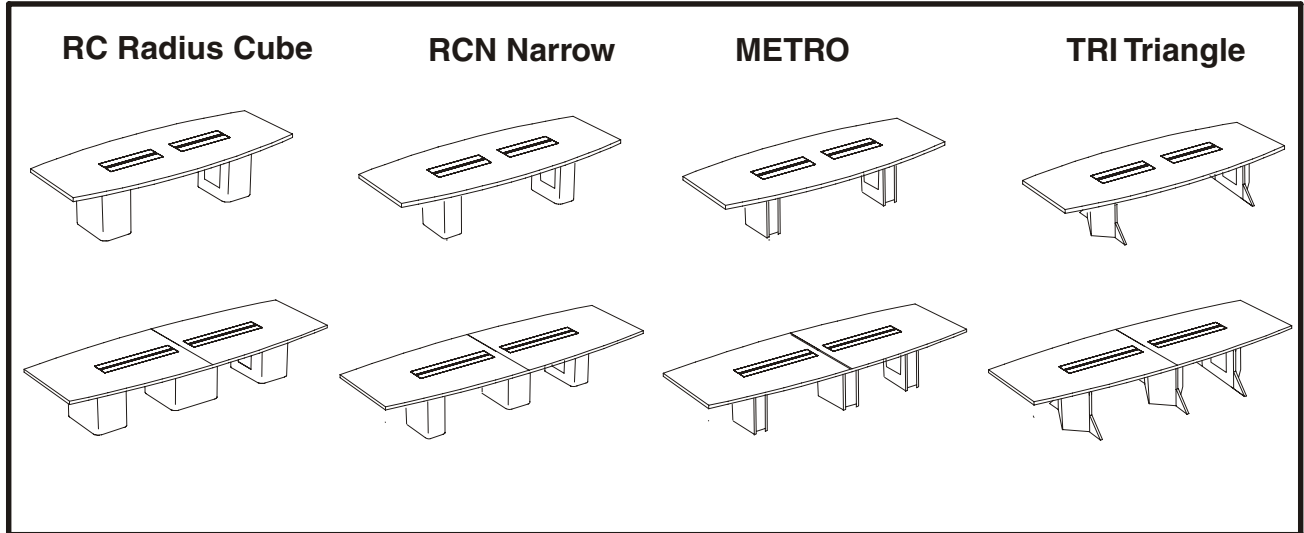

## ACT Table Overview

### Rectangle TT and Arrow TAR table base information

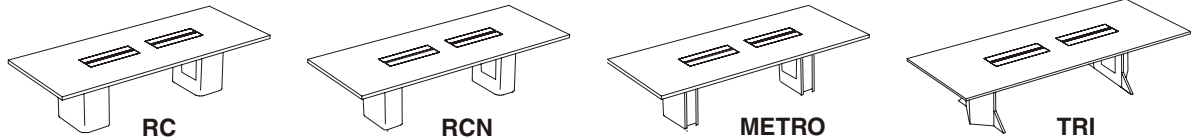

		(A)	RC base (C)				RCN base (C)				METRO base (C)				TRI base (C)			
Wide	Long	MLC	Qty	End	Center	IFE	Qty	End	Center	IFE	Qty	End	Center	IFE	Qty	End	Center	IFE
42	72	24	2	12x18		18	2	8x18		20	2	6x18		21	2	8x30		18
42	84	24	2	12x18		18	2	8x18		20	2	6x18		21	2	8x30		18
42	96	24	2	12x18		18	2	8x18		20	2	6x18		21	2	8x30		18
42	120	24	2	12x18		18	2	8x18		20	2	6x18		21	2	8x30		18
42	144	24	3	12x18	18x18	18	3	8x18	12x18	20	3	6x18	8x18	21	3	8x30	15x30	18
42	150	24	3	12x18	18x18	18	3	8x18	12x18	20	3	6x18	8x18	21	3	8x30	15x30	18
42	168	24	3	12x18	18x18	18	3	8x18	12x18	20	3	6x18	8x18	21	3	8x30	15x30	18
46	72	25	2	14x20		18	2	8x20		21	2	6x20		22	2	8x30		21
46	84	25	2	14x20		18	2	8x20		21	2	6x20		22	2	8x30		21
46	96	25	2	14x20		18	2	8x20		21	2	6x20		22	2	8x30		21
46	120	25	2	14x20		18	2	8x20		21	2	6x20		22	2	8x30		21
46	144	25	3	14x20	20x20	18	3	8x20	14x20	21	3	6x20	8x20	22	3	8x30	15x30	21
46	150	25	3	14x20	20x20	18	3	8x20	14x20	21	3	6x20	8x20	22	3	8x30	15x30	21
46	168	25	3	14x20	20x20	18	3	8x20	14x20	21	3	6x20	8x20	22	3	8x30	15x30	21
48	72	24	2	16x24		18	2	8x24		22	2	6x24		23	2	8x30		18
48	84	24	2	16x24		18	2	8x24		22	2	6x24		23	2	8x30		18
48	96	24	2	16x24		18	2	8x24		22	2	6x24		23	2	8x30		18
48	120	24	2	16x24		18	2	8x24		22	2	6x24		23	2	8x30		18
48	144	24	3	16x24	24x24	18	3	8x24	14x24	22	3	6x24	8x24	23	3	8x30	15x30	18
48	150	24	3	16x24	24x24	18	3	8x24	14x24	22	3	6x24	8x24	23	3	8x30	15x30	18
48	168	24	3	16x24	24x24	18	3	8x24	14x24	22	3	6x24	8x24	23	3	8x30	15x30	18
58	120	30	2	20x30		20	2	8x30		26	2	6x30		26	2	12x34		24
58	144	30	2	20x30		20	2	8x30		26	2	6x30		26	2	12x34		24
58	150	30	2	20x30		20	2	8x30		26	2	6x30		26	2	12x34		24
58	168	30	3	20x30	30x30	20	3	8x30	16x30	26	3	6x30	8x30	26	3	12x34	22x34	24
58	180	30	3	20x30	30x30	20	3	8x30	16x30	26	3	6x30	8x30	26	3	12x34	22x34	24
58	192	30	3	20x30	30x30	20	3	8x30	16x30	26	3	6x30	8x30	26	3	12x34	22x34	24
58	216	30	3	20x30	30x30	20	3	8x30	16x30	26	3	6x30	8x30	26	3	12x34	22x34	24
58	240	30	3	20x30	30x30	20	3	8x30	16x30	26	3	6x30	8x30	26	3	12x34	22x34	24
58	288	30(B)	4	20x30	30x30	20	4	8x30	16x30	26	4	6x30	8x30	26	4	12x34	22x34	24

(A) - MLC - center of the monument location is this distance from the end of the table

(B) - MLC - center base monument location is 104" or 8' 8" from the end of the table

(C) - IFE - Inset From End - how far is the base from the end of the table

#### Monument cutout for

RC Radius Cube and RCN Radius Cube Narrow bases is 6" less in each dimension. Exception for RC or RCN bases 8" or 9" long  
METRO bases at 6" wide is 3.75", at 8" wide is 5.75". For length, deduct 4" from the length of the base.

TRI end bases at 28 long, opening is 5" diameter, TRI center bases at 28" long, opening is 7".

TRI end bases at 34 long, opening is 7" diameter, TRI center bases at 34" long, opening is 7".

# ACT Table Overview

## Rectangle TT and Arrow TAR table base information

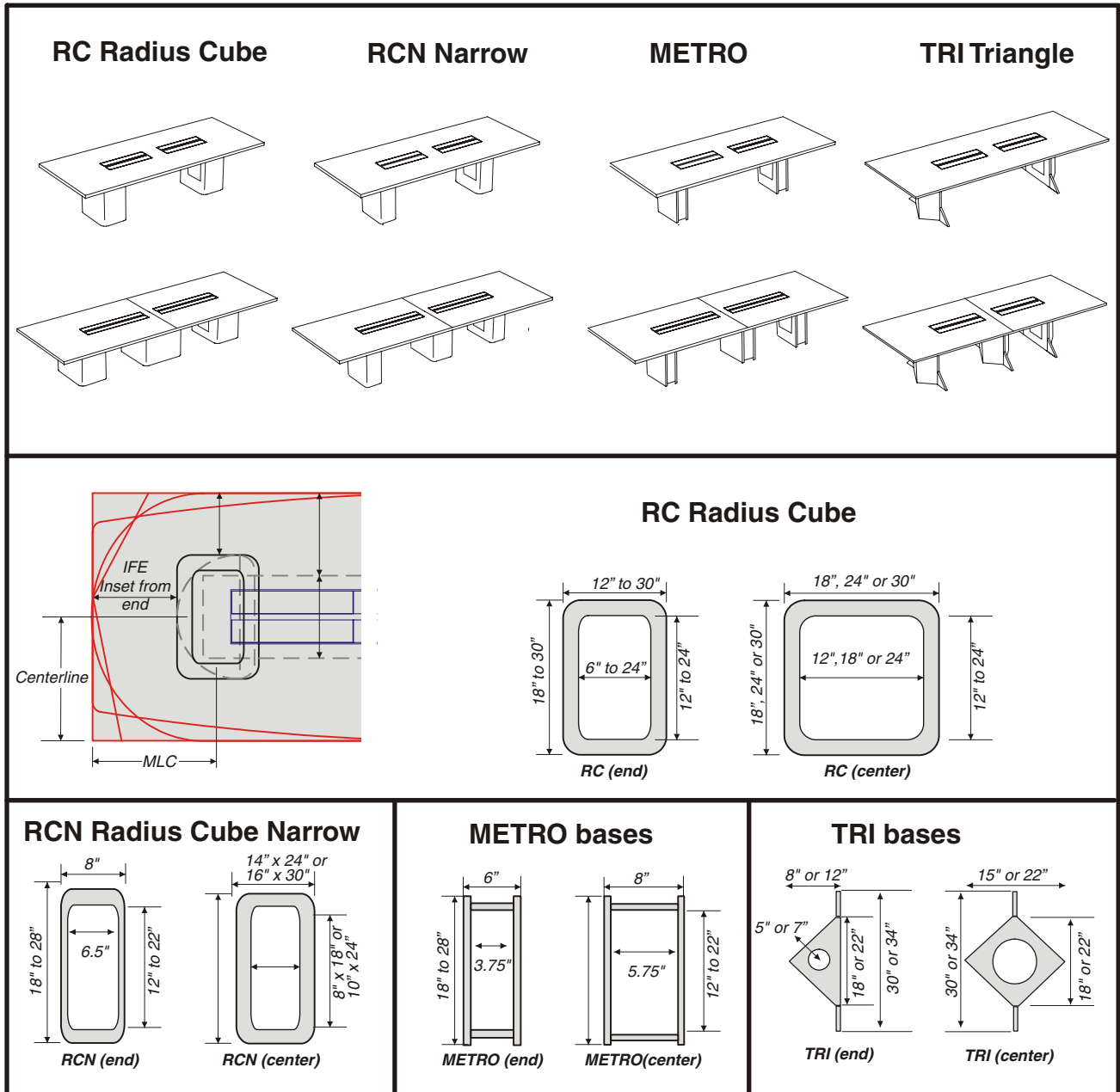



# ACT Table Overview

## Racetrack TR table base information

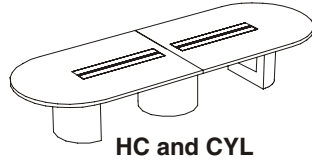
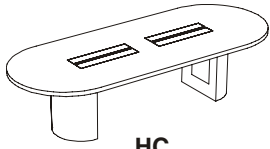

Wide	Long	(A) MLC	HC base			(C) IFE
			Qty	End	Center	
42	72	24	2	10x18		18
42	84	24	2	10x18		18
42	96	24	2	10x18		18
42	120	24	2	10x18		18
42	144	24	3	10x18	18x18	18
42	150	24	3	10x18	18x18	18
42	168	24	3	10x18	18x18	18
46	72	25	2	11x20		18
46	84	25	2	11x20		18
46	96	25	2	11x20		18
46	120	25	2	11x20		18
46	144	25	3	11x20	20x20	18
46	150	25	3	11x20	20x20	18
46	168	25	3	11x20	20x20	18
48	72	24	2	13x24		18
48	84	24	2	13x24		18
48	96	24	2	13x24		18
48	120	24	2	13x24		18
48	144	24	3	13x24	24x24	18
48	150	24	3	13x24	24x24	18
48	168	24	3	13x24	24x24	18
58	120	30	2	16x30		20
58	144	30	2	16x30		20
58	150	30	2	16x30		20
58	168	30	3	16x30	30x30	20
58	180	30	3	16x30	30x30	20
58	192	30	3	16x30	30x30	20
58	216	30	3	16x30	30x30	20
58	240	30	3	16x30	30x30	20
58	288	30(B)	4	16x30	30x30	20

**HC at ends, CYL in center**

**HC at ends**

**HC (end)**

**CYL in center**

**CYL (center)**

- (A) - MLC - center of the monument location is this distance from the end of the table
- (B) - MLC - center base monument location is 104" or 8' 8" from the end of the table
- (C) - IFE - Inset From End - how far is the base from the end of the table

**Monument cutout for**

HC Half Cylinder bases are 4" less in length and 6" less in width.

CYL Full Cylinder bases are 6" less in each dimension

# ACT Table Overview

## Delta TDE table base information

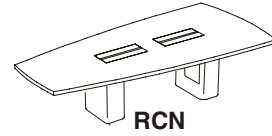
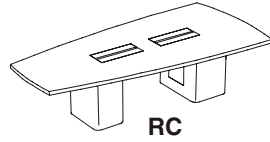

Wide	Long	MLC (A)		RC base (C)			RCN base (C)			RCN base (C)					
		Small	Big	Qty	Small	IFE	Big	IFE	Center	Qty	Small	IFE	Big	IFE	Center
58	96	35	28	2	14x20	28	20x30	18		2	8x20	31	16x30	20	
58	120	35	28	2	14x20	28	20x30	18		2	8x20	31	16x30	20	
58	144	35	28	2	14x20	28	20x30	18		2	8x20	31	16x30	20	
58	150	35	28	2	14x20	28	20x30	18		2	8x20	31	16x30	20	
58	168	35	28	3	14x20	28	20x30	18	30x30	3	8x20	31	16x30	20	16x30
58	180	35	28	3	14x20	28	20x30	18	30x30	3	8x20	31	16x30	20	16x30
58	192	35	28	3	14x20	28	20x30	18	30x30	3	8x20	31	16x30	20	16x30
58	216	35	28	3	14x20	28	20x30	18	30x30	3	8x20	31	16x30	20	16x30

(A) - MLC - center of the monument locaton from the end of the table - SMALL is the small end of the table, BIG is the big end of the table.

(C) - IFE - Inset From End - how far is the base from the end of the table

### Monument cutout for

RC Radius Cube and RCN Radius Cube Narrow bases is 6" less in each dimension. Exception for RC or RCN bases 8" or 9" long.

<p><b>RC Radius Cube</b>      <b>RCN Narrow</b></p>	<p><b>RC Radius Cube</b></p> <p>RC (small end)      RC (big end)</p>
	<p><b>RCN Radius Cube Narrow</b></p> <p>RCN (small end)      RCN (big end)</p>

## ACT Table Overview

### Round TD table base information

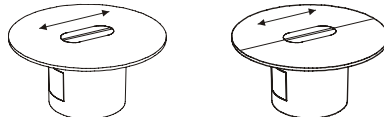

Diameter	(A)		CYL base		(C)
	MLC	Qty	Diameter	IFE	
58	29	1	30	14	
66	33	1	36	15	
72	36	1	36	18	

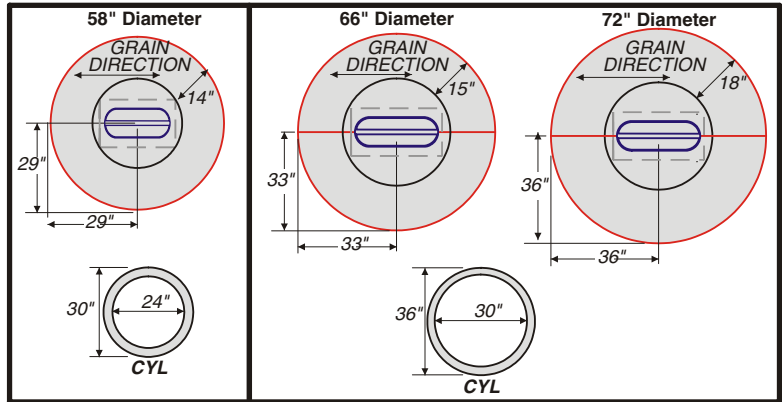

(A) - MLC - center of the monument locaton is this distance from the edge of the table

(C) - IFE - Inset From End - how far is the base from the edge of the table

Monument cutout for CYL Full Cylinder bases are 6" less in each dimension

### Egg shaped TEG table base information

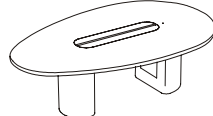

	(A)		RHC base			(C)
	MLC	Qty	Small	Big	IFE	
46	76		2	12x18	15x24	
58	96		2	12x16	17x28	

(A) - MLC - center of monument location shown in drawing to th e right.

(C) - IFE - Inset From End - shown in drawing o the right

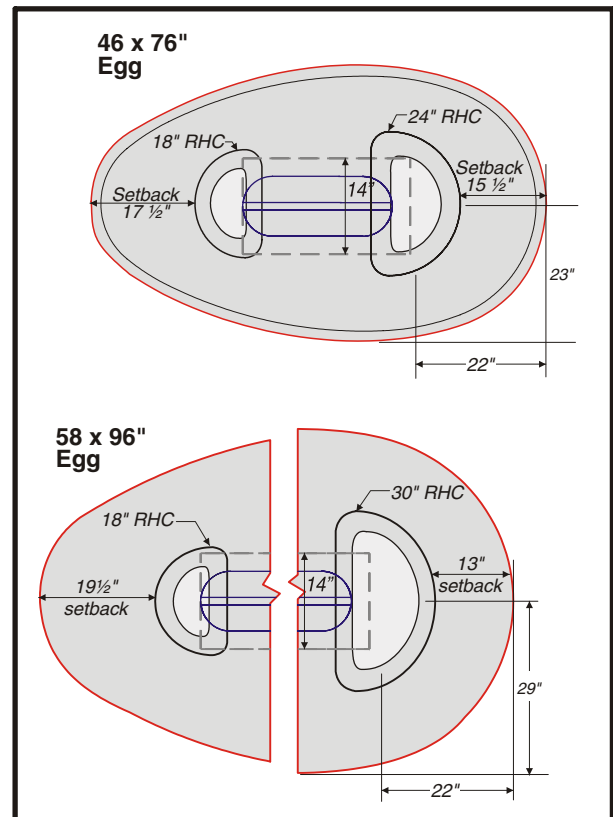

Monument cutout for RHC Radius Half Cylinder bases are 6" less in each dimension

# ACT Tables

## ACT Kaizen articulating table

Description	Model Number	Wgt	List Prices				
			WoodPlus	Standard	Detailed	2000	3000
<b>KAIZEN table</b>	TKZ-72144-AACE-RC	990	<b>33647</b>	33959	34426	35747	36655
	TKZ-72168-AACE-RC	1080	<b>35149</b>	35616	36039	37455	38427
	TKZ-72192-AACE-RC	1170	<b>35388</b>	35855	36501	37858	39004

KAIZEN table opens at either end or at both ends

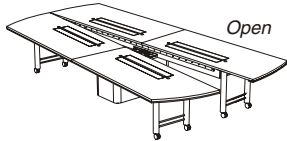

Open

Closed

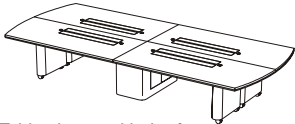
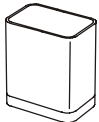

Table shown with the four RC-COVERS in place



Center Base Silver Accent

Top: 2 sides. Bases: Power entry at center of table and includes BHD Base Hinged Door. Includes MO20 ACT electrical outlets and faceplate bezels for data inserts and connectors. Includes the MINI-COVERS at the top of the HLEGS.

H-Leg standard finish is Black or Silver. Black will be provided unless otherwise specified.

Description	Model Number	Wgt	List Prices				
			WoodPlus	Standard	Detailed	2000	3000
<b>H-Leg Covers</b>	TKZ-RC-COVERS	32	<b>1264</b>	1264	1264	1264	1264

Four RC covers included, one for each HLEG on the table.  
RC covers match the center base finish color.

Description	Model Number	Wgt	List Prices				
			WoodPlus	Standard	Detailed	2000	3000
<b>Silver Accent Center Base</b>	BASE-SILVER-ACCENT-KAIZEN	0	<b>328</b>	328	328	328	328

Silver Accent strip for center base - 3" high.

Seating capacity and room size			
for the 144" (12') long table	seats 10 to 12	minimum room size 14' 6" by 20'	
for the 168" (14') long table	seats 14 to 16	minimum room size 16' 6" by 22'	
for the 192" (16') long table	seats 16 to 18	minimum room size 18' 6" by 24'	

144, 168, 192

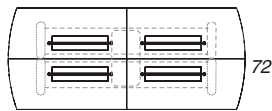

ACT Model Numbers:  
Shape 72 B ACE RC  
e.g. TKZ-72 168-ACE-RC

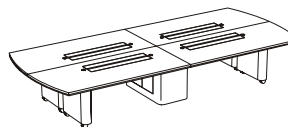

Table is closed

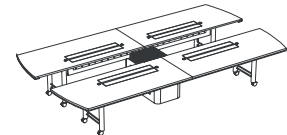
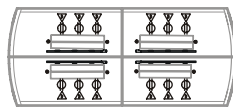

Table open at both ends



168" long table shown above

Table	Duplex	Bezels
144"	8	8
168"	12	12
192"	16	16

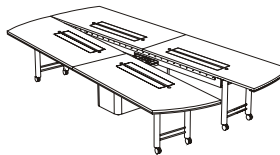

Table open end is to the right

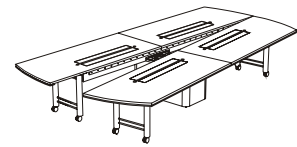

Table open end is to the left

**IMPORTANT: Tables are standard with wood grain running length of table.**

### Finish Colors

Specify ACT table Finish Colors.

For ACT tables table top doors match top finish.

For non-standard top laminates, please contact Customer Service for availability and upcharge.

Custom color wood edge on outside of table

See the end of this section for pricing on all options and accessories.

### Edge Options Information

- ACT tables are available with the following edge options:
- WoodPlus 3 mm PVC edge
  - Standard 3 mm Wood Edge
  - Detailed 3/8" Wood Edge
  - 2000 Series hardwood edges
  - 3000 Series hardwood edges

	WoodPlus 3 mm PVC	Standard Wood	Detailed Wood	2000 Wood	3000 Wood
Equations	WPES	SWES	RE	2000	1000
Modular 8	WPER	SWER	RA	2001	1100
	WPMS	SWMS	BE	2002	1200
	WPEN	SWEN	TR	2003	2200
	WPMS	SWMS	CL	2004	2100
	WPMN	SWMN			
	WPMR	SWMR			

# ACT Tables

## Mobile Utility Tables

Description	Model Number	Wgt	List Prices			2000	3000
			WoodPlus	Standard	Detailed		
<b>with Casters</b>	MUT-2419-CA	35	<b>907</b>	956	1141		

The MUT table base is available in black or silver.  
The top adjusts from 29" to 39".

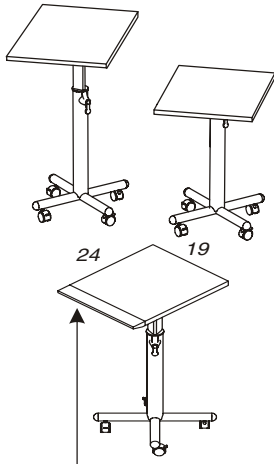

3400 edge shown along the 19" front edge of top

<b>Match table edge</b>	CREDENZA-2000-1LONG	356	
	CREDENZA-3000-1LONG		485

Match the tables 2000 series or 3000 series edge on one of the 19" long MUT table edges

<b>Add inlay</b>	CREDENZA-INLAY-BLACK	96	96
	CREDENZA-INLAY-BRASS	137	137
	CREDENZA-INLAY-CHROME	137	137

Add an inlay along the 2000 series or 3000 series edge

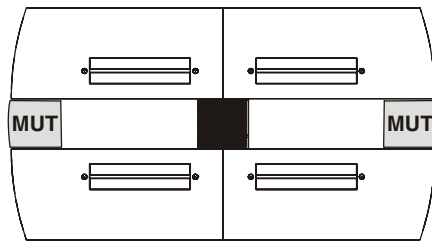

Two Mobile Utility Tables are used to expand the Kaizen table seating capacity

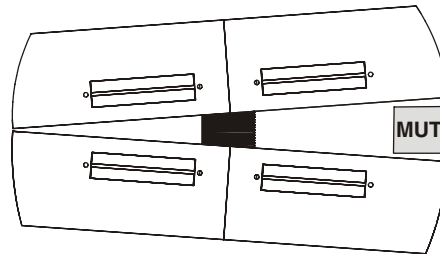

A Mobile Utility Table is used to hold the video projector or as a speaker's mini-lectern

### IMPORTANT: Tables are standard with wood grain running length of table.

#### Finish Colors

Specify ACT table Finish Colors.

For ACT tables table top doors match top finish.

For non-standard top laminates, please contact Customer Service for availability and upcharge.

Optional custom color wood edge is available

#### Notes:

- ACT tables are shipped RTA (ready to assemble)
- MO20 ACT Electrical is included. See overview page for details.
- ACT top doors are shipped installed in the ACT table
- Utility Bay is assembled with electrical included
- one Base Hinged Door (BHD) included with each ACT table It is installed on one of the 'end' base components Additional available as options.

#### Options

Options are built-in at factory

INLAY -available ONLY with Detailed or larger edge

INP Black 3mm (1/8") Inlay

INB Brushed Brass 3mm Inlay or

INC Satin Chrome 3mm Inlay

Rectangle top with Bow End or C3R

options uses the 'shape inlay' price.

When a Rectangular table top is ordered with 2000 Series edge and an inlay, please add the optional Bow End (BE) or the Corners with 3" Radius (C3R).

#### Options

Options are built-in at factory

BHD Base Hinged Door first one is included in ACT table in one of the base ends (RC, HC) or in TRI center base

Additional BHD are available in RC, HC, RHC or in full Cylinder

For Power source in Center base PE-C1

Power Entry cables and access door in center base instead of end base.

See the end of this section for

pricing on all options and accessories.

# ACT Tables

## Arrow ACT - Pyramid Base

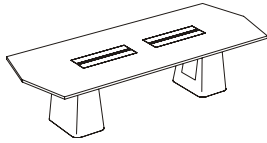

Description	Model Number	Wgt	List Prices				
			WoodPlus	Standard	Wood Edges		
					Detailed	2000	3000
<b>48" Wide</b>	TAR4884-ACE-PYR	360	<b>7990</b>	8190	8658	9539	9984
	TAR4896-ACE-PYR	389	<b>7900</b>	8089	8736	9923	10368
	TAR48120-ACE-PYR	487	<b>9124</b>	9358	9792	11055	11726

Top: 1 piece. Base: 2 PYR. Includes MO20 ACT electrical outlets. Power entry at one end base. 1 BHD Base Hinged Door included at Power entry end.

TAR48144-ACE-PYR	597	<b>11338</b>	11634	12117	13438	14346
TAR48150-ACE-PYR	612	<b>11801</b>	12095	12748	14609	15517
TAR48168-ACE-PYR	655	<b>13226</b>	13584	14116	15532	16504

Top: 2 piece. Base: 3 PYR. Includes MO20 ACT electrical outlets. Power entry at one end base. 1 BHD Base Hinged Door included at Power entry end.

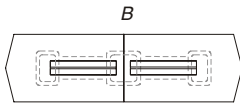

<b>58" Wide</b>	TAR58120-ACE-PYR	529	<b>9455</b>	9689	10123	11386	12057
-----------------	------------------	-----	-------------	------	-------	-------	-------

Top: 1 piece. Base: 2 PYR. Includes MO20 ACT electrical outlets. Power entry at one end base. 1 BHD Base Hinged Door included at Power entry end.

TAR58144-ACE-PYR	635	<b>10040</b>	10336	10819	12140	13048
TAR58150-ACE-PYR	652	<b>10464</b>	10758	11411	13191	14099

Top: 2 piece. Base: 2 PYR. Includes MO20 ACT electrical outlets. Power entry at one end base. 1 BHD Base Hinged Door included at Power entry end.

TAR58168-ACE-PYR	773	<b>13312</b>	13670	14202	15618	16590
TAR58180-ACE-PYR	807	<b>12784</b>	13225	14173	15857	16829
TAR58192-ACE-PYR	840	<b>13761</b>	14223	14763	16231	17377
TAR58216-ACE-PYR	986	<b>13461</b>	13902	15010	16738	17884
TAR58240-ACE-PYR	1052	<b>14971</b>	15438	16084	17884	19245

Top: 2 piece. Base: 3 PYR. Includes MO20 ACT electrical outlets. Power entry at one end base. 1 BHD Base Hinged Door included at Power entry end.

TAR58288-ACE-PYR	1337	<b>18314</b>	18710	19872	21731	23435
------------------	------	--------------	-------	-------	-------	-------

Top: 3 piece. Base: 4 PYR. Includes MO20 ACT electrical outlets. Power entry at one end base. 1 BHD Base Hinged Door included at Power entry end.

ACT Model Numbers:  
Shape A B ACE Base  
e.g. TAR 48 168 ACE PYR

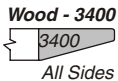

**IMPORTANT: Tables are standard with wood grain running length of table.**

### Finish Colors

Specify ACT table Finish Colors.

For ACT tables table top doors match top finish.

For non-standard top laminates, please contact Customer Service for availability and upcharge.

Custom color wood edge on outside of table

See the end of this section for pricing on all options and accessories.

### Edge Options Information

ACT tables are available with the following edge options:

- WoodPlus 3 mm PVC edge
- Standard 3 mm Wood Edge
- Detailed 3/8" Wood Edge
- 2000 Series hardwood edges
- 3000 Series hardwood edges

	WoodPlus 3 mm PVC	Standard Wood	Detailed Wood	2000 Wood	3000 Wood
Equations	WPES	SWES	RE	2000	1000
Equations	WPER	SWER	RA	2001	1100
Modular 8	WPMS	SWMS	BE	2002	1200
Modular 8	WPEN	SWEN	TR	2003	2200
	WPMN	SWMN	CL	2004	2100
	WPMR	SWMR			

## ACT Tables

### Arrow ACT - Triangle Base

Description	Model Number	Wgt	List Prices				
			WoodPlus	Standard	Detailed	2000	3000
<b>42" wide</b>	TAR4272-ACE-TRI	321	<b>5440</b>	5635	6008	6684	7206
<b>26" wide base</b>	Top: 1 piece; Base: 2 TRI. Includes MO20 ACT electrical outlets and power entry.						
	TAR4284-ACE-TRI	350	<b>5717</b>	5917	6385	7266	7711
	TAR4296-ACE-TRI	379	<b>6076</b>	6276	6744	7625	8070
	TAR42120-ACE-TRI	467	<b>6825</b>	7059	7493	8756	9427
	Top: 1 piece; Base: 2 TRI. Includes MO20 ACT electrical outlets and power entry.						
	TAR42144-ACE-TRI	577	<b>7375</b>	7671	8154	9475	10383
	TAR42150-ACE-TRI	592	<b>7650</b>	7946	8429	9750	10658
	TAR42168-ACE-TRI	630	<b>8243</b>	8601	9133	10549	11521
	Top: 2 piece; Base: 3 TRI. Includes MO20 ACT electrical outlets and power entry.						
<b>48" wide</b>	TAR4872-ACE-TRI	311	<b>5440</b>	5635	6008	6684	7206
<b>26" wide base</b>	Top: 1 piece; Base: 2 TRI. Includes MO20 ACT electrical outlets and power entry.						
	TAR4884-ACE-TRI	340	<b>5717</b>	5917	6385	7266	7711
	TAR4896-ACE-TRI	369	<b>6076</b>	6276	6744	7625	8070
	TAR48120-ACE-TRI	467	<b>6825</b>	7059	7493	8756	9427
	Top: 1 piece; Base: 2 TRI. Includes MO20 ACT electrical outlets and power entry.						
	TAR48144-ACE-TRI	567	<b>7375</b>	7671	8154	9475	10383
	TAR48150-ACE-TRI	582	<b>7650</b>	7946	8429	9750	10658
	TAR48168-ACE-TRI	625	<b>8243</b>	8601	9133	10549	11521
	Top: 2 piece; Base: 3 TRI. Includes MO20 ACT electrical outlets and power entry.						
<b>58" wide</b>	TAR58120-ACE-TRI	509	<b>7096</b>	7330	7764	9027	9698
<b>32" wide base</b>	Top: 1 piece; Base: 2 TRI. Includes MO20 ACT electrical outlets and power entry.						
	TAR58144-ACE-TRI	575	<b>7959</b>	8255	8738	10059	10967
	TAR58150-ACE-TRI	592	<b>8042</b>	8338	8821	10142	11050
	Top: 2 piece; Base: 2 TRI. Includes MO20 ACT electrical outlets and power entry.						
	TAR58168-ACE-TRI	683	<b>8591</b>	8949	9481	10897	11869
	TAR58180-ACE-TRI	717	<b>10035</b>	10393	10925	12341	13313
	TAR58192-ACE-TRI	830	<b>10218</b>	10680	11220	12688	13834
	TAR58216-ACE-TRI	896	<b>10530</b>	10992	11532	13000	14146
	TAR58240-ACE-TRI	962	<b>11079</b>	11546	12192	13992	15353
	Top: 2 piece; Base: 3 TRI. Includes MO20 ACT electrical outlets and power entry.						
	TAR58288-ACE-TRI	1217	<b>12152</b>	12548	13710	15569	17273
	Top: 3 piece; Base: 4 TRI. Includes MO20 ACT electrical outlets and power entry.						

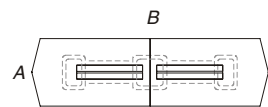
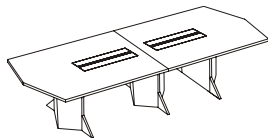

ACT Model Numbers:  
Shape A B ACE Base  
e.g. TAR 48 168 ACE PYR

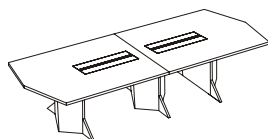
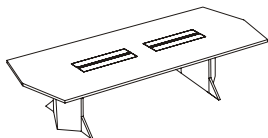

Table base 'wedges' are available in either black or silver finish.

#### Finish Colors

Specify ACT table Finish Colors.

For ACT tables table top doors match top finish.

For non-standard top laminates, please contact Customer Service for availability and upcharge.

Optional custom color wood edge is available

#### Notes:

- ACT tables are shipped RTA (ready to assemble)
- MO20 ACT Electrical is included. See overview page for details.
- ACT top doors are shipped installed in the ACT table top
- Utility Bay is assembled with electrical included
- one Base Hinged Door (BHD) included with each ACT table It is installed on one of the 'end' base components Additional available as options.

#### Options

Options are built-in at factory

- INLAY -available ONLY with Detailed or larger edge
- INP Black 3mm (1/8") Inlay
- INB Brushed Brass 3mm Inlay or
- INC Satin Chrome 3mm Inlay
- Rectangle top with Bow End or C3R options uses the 'shape inlay' price.
- When a Rectangular table top is ordered with 2000 Series edge and an inlay, please add the optional Bow End (BE) or the Corners with 3" Radius (C3R).

#### Options

Options are built-in at factory

- BHD Base Hinged Door first one is included in ACT table in one of the base ends (RC, HC) or in TRI center base
- Additional BHD are available in RC, HC, RHC or in full Cylinder
- For Power source in Center base PE-C1
- Power Entry cables and access door in center base instead of end base.
- See the end of this section for pricing on all options and accessories.



# ACT Tables

## Rectangular ACT - Radius Cube Base

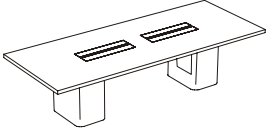
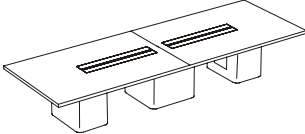
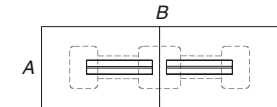
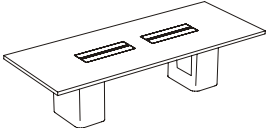
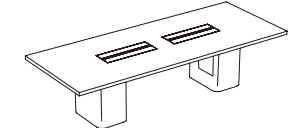
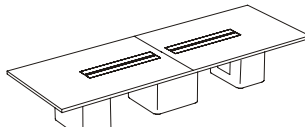
Description	Model Number	Wgt	List Prices				
			WoodPlus	Standard	Detailed	2000	3000
 <p><b>42" wide</b> <b>24" wide base</b></p>	TT4272-ACE-RC	321	<b>5029</b>	5229	5530	6051	6572
	Top: 1 piece; Base: 2 RC. Includes MO20 ACT electrical outlets and power entry.						
	TT4284-ACE-RC	350	<b>5490</b>	5690	6047	6816	7261
	TT4296-ACE-RC	379	<b>5682</b>	5882	6239	7008	7453
	TT42120-ACE-RC	467	<b>6282</b>	6516	6839	7991	8662
Top: 1 piece; Base: 2 RC. Includes MO20 ACT electrical outlets and power entry.							
	TT42144-ACE-RC	577	<b>7504</b>	7816	8172	9381	10178
	TT42150-ACE-RC	592	<b>8435</b>	8747	9103	10312	10442
	TT42168-ACE-RC	630	<b>9041</b>	9508	9820	10995	11222
	Top: 2 piece; Base: 3 RC. Includes MO20 ACT electrical outlets and power entry.						
	 <p><b>48" wide</b> <b>24" wide base</b></p>	TT4872-ACE-RC	331	<b>5029</b>	5229	5530	6051
Top: 1 piece; Base: 2 RC. Includes MO20 ACT electrical outlets and power entry.							
TT4884-ACE-RC		360	<b>5490</b>	5690	6047	6816	7261
TT4896-ACE-RC		389	<b>5682</b>	5882	6239	7008	7453
TT48120-ACE-RC		487	<b>6282</b>	6516	6839	7991	8662
Top: 1 piece; Base: 2 RC. Includes MO20 ACT electrical outlets and power entry.							
	TT48144-ACE-RC	597	<b>7504</b>	7816	8172	9381	10178
	TT48150-ACE-RC	612	<b>8435</b>	8747	9103	10312	10442
	TT48168-ACE-RC	655	<b>9041</b>	9508	9820	10995	11222
	Top: 2 piece; Base: 3 RC. Includes MO20 ACT electrical outlets and power entry.						
	 <p><b>58" wide</b> <b>30" wide base</b></p>	TT58120-ACE-RC	529	<b>6707</b>	6941	7264	8416
Top: 1 piece; Base: 2 RC. Includes MO20 ACT electrical outlets and power entry.							
TT58144-ACE-RC		635	<b>7143</b>	7455	7811	9020	9817
TT58150-ACE-RC		652	<b>7945</b>	8257	8613	9822	9952
Top: 2 piece; Base: 2 RC. Includes MO20 ACT electrical outlets and power entry.							
	TT58168-ACE-RC	773	<b>9340</b>	9807	10119	11300	11549
	TT58180-ACE-RC	807	<b>9578</b>	10045	10357	11550	12522
	TT58192-ACE-RC	840	<b>9694</b>	10161	10584	11941	12976
	TT58216-ACE-RC	986	<b>9834</b>	10301	10724	12081	13116
	TT58240-ACE-RC	1052	<b>10359</b>	10826	11361	12999	14299
Top: 2 piece; Base: 3 RC. Includes MO20 ACT electrical outlets and power entry.							
TT58288-ACE-RC	1337	<b>12581</b>	12977	13917	15665	17368	
Top: 3 piece; Base: 4 RC. Includes MO20 ACT electrical outlets and power entry.							

ACT Model Numbers:  
Shape A B ACE Base  
e.g. TT 58 168 ACE RC

**IMPORTANT: Tables are standard with wood grain running length of table.**

### Finish Colors

Specify ACT table Finish Colors.

For ACT tables table top doors match top finish.

For non-standard top laminates, please contact Customer Service for availability and upcharge.

Custom color wood edge on outside of table

See the end of this section for pricing on all options and accessories.

### Edge Options Information

ACT tables are available with the following edge options:

- WoodPlus 3 mm PVC edge
- Standard 3 mm Wood Edge
- Detailed 3/8" Wood Edge
- 2000 Series hardwood edges
- 3000 Series hardwood edges

	WoodPlus 3 mm PVC	Standard Wood	Detailed Wood	2000 Wood	3000 Wood
Equations	WPES	SWES	RE	2000	1000
Modular 8	WPER	SWER	RA	2001	1100
	WPEN	SWEN	BE	2002	1200
	WPMS	SWMS	TR	2003	2200
	WPMN	SWMN	CL	2004	2100
	WPMP	SWMP			



## ACT Tables

### Rectangular ACT - Triangle Base

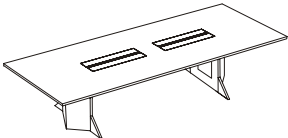
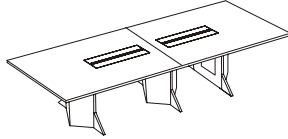
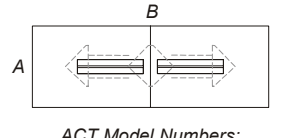
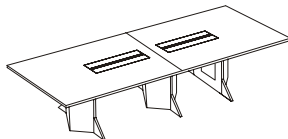
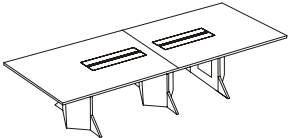
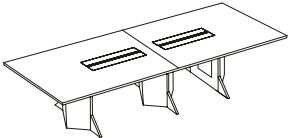
Description	Model Number	Wgt	List Prices					
			WoodPlus	Standard	Wood Edges			
					Detailed	2000	3000	
	<b>42" wide</b>	TT4272-ACE-TRI	321	<b>5029</b>	5229	5530	6051	6572
	<b>24" wide base</b>	Top: 1 piece; Base: 2 TRI. Includes MO20 ACT electrical outlets and power entry.						
		TT4284-ACE-TRI	350	<b>5490</b>	5690	6047	6816	7261
		TT4296-ACE-TRI	379	<b>5682</b>	5882	6239	7008	7453
		TT42120-ACE-TRI	467	<b>6282</b>	6516	6839	7991	8662
Top: 1 piece; Base: 2 TRI. Includes MO20 ACT electrical outlets and power entry.								
	TT42144-ACE-TRI	577	<b>7504</b>	7816	8172	9381	10178	
	TT42150-ACE-TRI	592	<b>8435</b>	8747	9103	10312	10442	
	TT42168-ACE-TRI	630	<b>9041</b>	9508	9820	10995	11222	
	<b>48" wide</b>	Top: 2 piece; Base: 3 TRI. Includes MO20 ACT electrical outlets and power entry.						
		TT4872-ACE-TRI	331	<b>5029</b>	5229	5530	6051	6572
	<b>24" wide base</b>	Top: 1 piece; Base: 2 TRI. Includes MO20 ACT electrical outlets and power entry.						
		TT4884-ACE-TRI	360	<b>5490</b>	5690	6047	6816	7261
		TT4896-ACE-TRI	389	<b>5682</b>	5882	6239	7008	7453
		TT48120-ACE-TRI	487	<b>6282</b>	6516	6839	7991	8662
		Top: 1 piece; Base: 2 TRI. Includes MO20 ACT electrical outlets and power entry.						
	TT48144-ACE-TRI	597	<b>7504</b>	7816	8172	9381	10178	
	TT48150-ACE-TRI	612	<b>8435</b>	8747	9103	10312	10442	
	TT48168-ACE-TRI	655	<b>9041</b>	9508	9820	10995	11222	
	<b>58" wide</b>	Top: 2 piece; Base: 3 TRI. Includes MO20 ACT electrical outlets and power entry.						
		TT58120-ACE-TRI	529	<b>6707</b>	6941	7264	8416	9087
	<b>30" wide base</b>	Top: 1 piece; Base: 2 TRI. Includes MO20 ACT electrical outlets and power entry.						
		TT58144-ACE-TRI	635	<b>7143</b>	7455	7811	9020	9817
		TT58150-ACE-TRI	652	<b>7945</b>	8257	8613	9822	9952
		Top: 2 piece; Base: 2 TRI. Includes MO20 ACT electrical outlets and power entry.						
		TT58168-ACE-TRI	773	<b>9340</b>	9807	10119	11300	11549
	TT58180-ACE-TRI	807	<b>9578</b>	10045	10357	11550	12522	
	TT58192-ACE-TRI	840	<b>9694</b>	10161	10584	11941	12976	
	TT58216-ACE-TRI	986	<b>9834</b>	10301	10724	12081	13116	
	TT58240-ACE-RC	1052	<b>10359</b>	10826	11361	12999	14299	
	Top: 2 piece; Base: 3 RC. Includes MO20 ACT electrical outlets and power entry.							
	TT58288-ACE-RC	1337	<b>12581</b>	12977	13917	15665	17368	
	Top: 3 piece; Base: 4 RC. Includes MO20 ACT electrical outlets and power entry.							

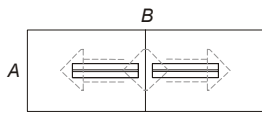

ACT Model Numbers:  
Shape A B ACE Base  
e.g. TT 58 168 ACE RC

Table base 'wedges' are available in either black or silver finish.

#### Finish Colors

Specify ACT table Finish Colors.

For ACT tables table top doors match top finish.

For non-standard top laminates, please contact Customer Service for availability and upcharge.

Optional custom color wood edge is available

#### Notes:

- ACT tables are shipped RTA (ready to assemble)
- MO20 ACT Electrical is included. See overview page for details.
- ACT top doors are shipped installed in the ACT table top
- Utility Bay is assembled with electrical included
- one Base Hinged Door (BHD) included with each ACT table It is installed on one of the 'end' base components Additional available as options.

#### Options

Options are built-in at factory

- INLAY -available ONLY with Detailed or larger edge
- INP Black 3mm (1/8") Inlay
- INB Brushed Brass 3mm Inlay or
- INC Satin Chrome 3mm Inlay
- Rectangle top with Bow End or C3R options uses the 'shape inlay' price.
- When a Rectangular table top is ordered with 2000 Series edge and an inlay, please add the optional Bow End (BE) or the Corners with 3" Radius (C3R).

#### Options

Options are built-in at factory

- BHD Base Hinged Door first one is included in ACT table in one of the base ends (RC, HC) or in TRI center base
- Additional BHD are available in RC, HC, RHC or in full Cylinder
- For Power source in Center base PE-C1
- Power Entry cables and access door in center base instead of end base.
- See the end of this section for pricing on all options and accessories.

# ACT Tables

## Boat Shape ACT - Radius Cube Base

Description	Model Number	Wgt	List Prices					
			WoodPlus	Standard	Detailed	2000	3000	
<b>42" wide</b> <b>24" wide base</b>	TB4272-ACE-RC	321	<b>5440</b>	5640	6053	6684	7206	
	TB4284-ACE-RC	350	<b>5717</b>	5917	6385	7266	7711	
	TB4296-ACE-RC	379	<b>6076</b>	6276	6744	7625	8070	
	TB42120-ACE-RC	467	<b>6825</b>	7059	7493	8756	9427	
Top: 1 piece; Base: 2 RC. Includes MO20 ACT electrical outlets and power entry.								
<b>48" wide</b> <b>24" wide base</b>	TB42144-ACE-RC	577	<b>7632</b>	7944	8411	9732	10640	
	TB42150-ACE-RC	592	<b>8561</b>	8873	9340	10661	11569	
	TB42168-ACE-RC	630	<b>9167</b>	9634	10057	11473	12445	
	TB4872-ACE-RC	331	<b>5440</b>	5640	6053	6684	7206	
<b>48" wide</b> <b>24" wide base</b>	TB4884-ACE-RC	360	<b>5717</b>	5917	6385	7266	7711	
	TB4896-ACE-RC	389	<b>6076</b>	6276	6744	7625	8070	
	TB48120-ACE-RC	487	<b>6825</b>	7059	7493	8756	9427	
	TB48144-ACE-RC	597	<b>7632</b>	7944	8411	9732	10640	
<b>58" wide</b> <b>30" wide base</b>	TB48150-ACE-RC	612	<b>8561</b>	8873	9340	10661	11569	
	TB48168-ACE-RC	655	<b>9167</b>	9634	10057	11473	12445	
	TB58120-ACE-RC	529	<b>7096</b>	7330	7764	9027	9698	
	TB58144-ACE-RC	635	<b>7959</b>	8271	8738	10059	10967	
<b>58" wide</b> <b>30" wide base</b>	TB58150-ACE-RC	652	<b>8678</b>	8990	9457	10778	11686	
	TB58168-ACE-RC	773	<b>9465</b>	9932	10355	11771	12743	
	TB58180-ACE-RC	807	<b>10035</b>	10502	10925	12341	13313	
	TB58192-ACE-RC	840	<b>10218</b>	10685	11331	12688	13834	
	TB58216-ACE-RC	986	<b>10530</b>	10997	11643	13000	14146	
	TB58240-ACE-RC	1052	<b>11079</b>	11546	12192	13992	15353	
	TB58288-ACE-RC	1337	<b>12708</b>	13175	14266	16125	16142	
	Top: 3 piece; Base: 4 RC. Includes MO20 ACT electrical outlets and power entry.							

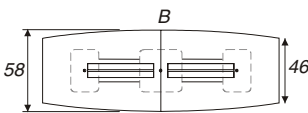
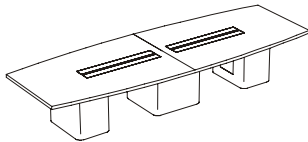
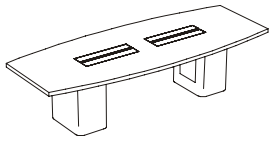

ACT Model Numbers:  
Shape width B ACE Base  
e.g. TB 58 168 ACE RC

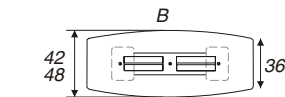

ACT Model Numbers:  
Shape width B ACE Base  
e.g. TB 48 120 ACE RC

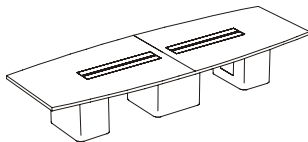
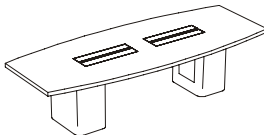

**IMPORTANT: Tables are standard with wood grain running length of table.**

### Finish Colors

Specify ACT table Finish Colors.

For ACT tables table top doors match top finish.

For non-standard top laminates, please contact Customer Service for availability and upcharge.

Custom color wood edge on outside of table

See the end of this section for pricing on all options and accessories.

### Edge Options Information

- ACT tables are available with the following edge options:
- WoodPlus 3 mm PVC edge
  - Standard 3 mm Wood Edge
  - Detailed 3/8" Wood Edge
  - 2000 Series hardwood edges
  - 3000 Series hardwood edges

WoodPlus 3 mm PVC	Standard Wood	Detailed Wood	2000 Wood	3000 Wood
Equations WPES	Equations SWES	RE	2000	1000
Modular 8 WPER	Modular 8 SWER	RA	2001	1100
WPMS	SWMS	BE	2002	1200
WPEN	SWEN	TR	2003	2200
WPMN	SWMN	CL	2004	2100
WPMP	SWMP			

## ACT Tables

### Boat Shape ACT - Triangle Base

Description	Model Number	Wgt	List Prices					
			WoodPlus	Standard	Wood Edges			
					Detailed	2000	3000	
<b>42" wide</b> <b>24" wide base</b>	TB4272-ACE-TRI	321	<b>5440</b>	5640	6053	6684	7206	
	TB4284-ACE-TRI	350	<b>5717</b>	5917	6385	7266	7711	
	TB4296-ACE-TRI	379	<b>6076</b>	6276	6744	7625	8070	
	TB42120-ACE-TRI	467	<b>6825</b>	7059	7493	8756	9427	
Top: 1 piece; Base: 2 TRI. Includes MO20 ACT electrical outlets and power entry.								
<b>48" wide</b> <b>24" wide base</b>	TB42144-ACE-TRI	577	<b>7632</b>	7944	8411	9732	10640	
	TB42150-ACE-TRI	592	<b>8561</b>	8873	9340	10661	11569	
	TB42168-ACE-TRI	630	<b>9167</b>	9634	10057	11473	12445	
	Top: 2 piece; Base: 3 TRI. Includes MO20 ACT electrical outlets and power entry.							
<b>58" wide</b> <b>30" wide base</b>	TB4872-ACE-TRI	331	<b>5440</b>	5640	6053	6684	7206	
	TB4884-ACE-TRI	360	<b>5717</b>	5917	6385	7266	7711	
	TB4896-ACE-TRI	389	<b>6076</b>	6276	6744	7625	8070	
	TB48120-ACE-TRI	487	<b>6825</b>	7059	7493	8756	9427	
Top: 1 piece; Base: 2 TRI. Includes MO20 ACT electrical outlets and power entry.								
<b>58" wide</b> <b>30" wide base</b>	TB48144-ACE-TRI	597	<b>7632</b>	7944	8411	9732	10640	
	TB48150-ACE-TRI	612	<b>8561</b>	8873	9340	10661	11569	
	TB48168-ACE-TRI	655	<b>9167</b>	9634	10057	11473	12445	
	Top: 2 piece; Base: 3 TRI. Includes MO20 ACT electrical outlets and power entry.							
<b>58" wide</b> <b>30" wide base</b>	TB58120-ACE-TRI	529	<b>7096</b>	7330	7764	9027	9698	
	Top: 1 piece; Base: 2 TRI. Includes MO20 ACT electrical outlets and power entry.							
	TB58144-ACE-TRI	635	<b>7959</b>	8271	8738	10059	10967	
	TB58150-ACE-TRI	652	<b>8678</b>	8990	9457	10778	11686	
	Top: 2 piece; Base: 2 TRI. Includes MO20 ACT electrical outlets and power entry.							
	TB58168-ACE-TRI	773	<b>9465</b>	9932	10355	11771	12743	
	TB58180-ACE-TRI	807	<b>10035</b>	10502	10925	12341	13313	
	TB58192-ACE-TRI	840	<b>10218</b>	10685	11331	12688	13834	
TB58216-ACE-TRI	986	<b>10530</b>	10997	11643	13000	14146		
TB58240-ACE-TRI	1052	<b>11079</b>	11546	12192	13992	15353		
Top: 2 piece; Base: 3 TRI. Includes MO20 ACT electrical outlets and power entry.								
TB58288-ACE-TRI	1337	<b>12708</b>	13175	14266	16125	16142		
Top: 3 piece; Base: 4 TRI. Includes MO20 ACT electrical outlets and power entry.								

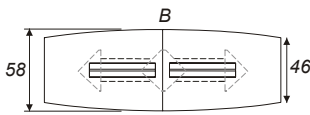
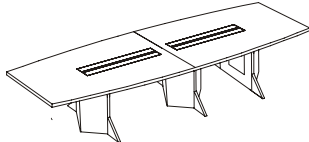
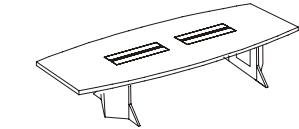

ACT Model Numbers:  
Shape width B ACE Base  
e.g. TB 58 168 ACE TRI

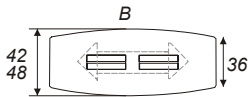

ACT Model Numbers:  
Shape width B ACE Base  
e.g. TB 48 120 ACE TRI

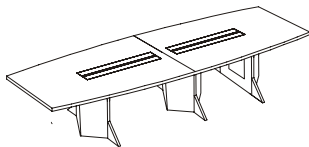

Table base 'wedges' are available in either black or silver finish.

**IMPORTANT: Tables are standard with wood grain running length of table.**

#### Finish Colors

Specify ACT table Finish Colors.

For ACT tables table top doors match top finish.

For non-standard top laminates, please contact Customer Service for availability and upcharge.

Optional custom color wood edge is available

#### Notes:

- ACT tables are shipped RTA (ready to assemble)
- MO20 ACT Electrical is included. See overview page for details.
- ACT top doors are shipped installed in the ACT table
- Utility Bay is assembled with electrical included
- one Base Hinged Door (BHD) included with each ACT table It is installed on one of the 'end' base components Additional available as options.

#### Options

Options are built-in at factory

- INLAY -available ONLY with Detailed or larger edge
- INP Black 3mm (1/8") Inlay
- INB Brushed Brass 3mm Inlay or
- INC Satin Chrome 3mm Inlay
- Rectangle top with Bow End or C3R options uses the 'shape inlay' price.

When a Rectangular table top is ordered with 2000 Series edge and an inlay, please add the optional Bow End (BE) or the Corners with 3" Radius (C3R).

#### Options

Options are built-in at factory

- BHD Base Hinged Door first one is included in ACT table in one of the base ends (RC, HC) or in TRI center base
- Additional BHD are available in RC, HC, RHC or in full Cylinder
- For Power source in Center base PE-C1
- Power Entry cables and access door in center base instead of end base.
- See the end of this section for pricing on all options and accessories.

# ACT Tables

## Racetrack ACT - Half Cylinder Base

Description	Model Number	Wgt	List Prices					
			WoodPlus	Standard	Wood Edges			
					Detailed	2000	3000	
<b>42" wide</b> <b>24" wide base</b>	TR4272-ACE-HC	321	<b>5440</b>	5640	6053	6684	7206	
	TR4284-ACE-HC	350	<b>5717</b>	5917	6385	7266	7711	
	TR4296-ACE-HC	379	<b>6076</b>	6276	6744	7625	8070	
	TR42120-ACE-HC	467	<b>6825</b>	7059	7493	8756	9427	
Top: 1 piece; Base: 2 HC. Includes MO20 ACT electrical outlets and power entry.								
<b>48" wide</b> <b>24" wide base</b>	TR42144-ACE-HC	577	<b>7375</b>	7687	8154	9475	10383	
	TR42150-ACE-HC	592	<b>7650</b>	7962	8429	9750	10658	
	TR42168-ACE-HC	630	<b>8243</b>	8710	9133	10549	11521	
	TR4872-ACE-HC	311	<b>5440</b>	5640	6053	6684	7206	
<b>48" wide</b> <b>24" wide base</b>	TR4884-ACE-HC	340	<b>5717</b>	5917	6385	7266	7711	
	TR4896-ACE-HC	369	<b>6076</b>	6276	6744	7625	8070	
	TR48120-ACE-HC	467	<b>6825</b>	7059	7493	8756	9427	
	TR48144-ACE-HC	567	<b>7375</b>	7687	8154	9475	10383	
<b>58" wide</b> <b>30" wide base</b>	TR48150-ACE-HC	582	<b>7650</b>	7962	8429	9750	10658	
	TR48168-ACE-HC	625	<b>8243</b>	8710	9133	10549	11521	
	TR58120-ACE-HC	509	<b>7096</b>	7330	7764	9027	9698	
	TR58144-ACE-HC	575	<b>7959</b>	8271	8738	10059	10967	
<b>58" wide</b> <b>30" wide base</b>	TR58150-ACE-HC	592	<b>8042</b>	8354	8821	10142	11050	
	Top: 2 piece; Base: 2 HC. Includes MO20 ACT electrical outlets and power entry.							
	TR58168-ACE-HC	683	<b>8591</b>	9058	9481	10897	11869	
	TR58180-ACE-HC	717	<b>10035</b>	10502	10925	12341	13313	
	TR58192-ACE-HC	830	<b>10218</b>	10685	11331	12688	13834	
	TR58216-ACE-HC	896	<b>10530</b>	10997	11643	13000	14146	
	TR58240-ACE-HC	962	<b>11079</b>	11546	12192	13992	15353	
	Top: 2 piece; Base: 2 HC, 1 CYL. Includes MO20 ACT electrical outlets and power entry.							
TR58288-ACE-HC	1217	<b>12152</b>	12548	13710	15569	17273		
Top: 3 piece; Base: 2 HC, 2 CYL. Includes MO20 ACT electrical outlets and power entry.								

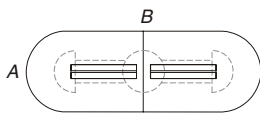
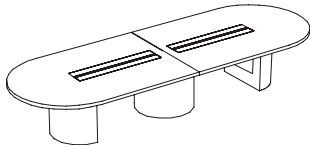
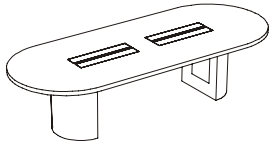

ACT Model Numbers:  
Shape A B ACE Base  
e.g. TB 58 168 ACE RC

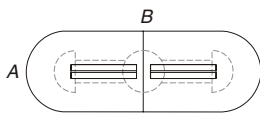
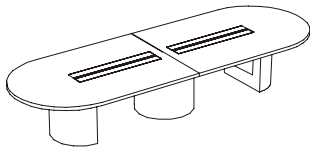
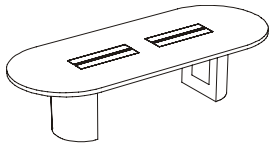

ACT Model Numbers:  
Shape A B ACE Base  
e.g. TB 58 168 ACE RC

**IMPORTANT: Tables are standard with wood grain running length of table.**

### Finish Colors

Specify ACT table Finish Colors.

For ACT tables

table top doors match top finish.

For non-standard top laminates,  
please contact Customer Service  
for availability and upcharge.

Custom color wood edge  
on outside of table

See the end of this section for  
pricing on all options and  
accessories.

### Edge Options Information

ACT tables are available with  
the following edge options:

- WoodPlus 3 mm PVC edge
- Standard 3 mm Wood Edge
- Detailed 3/8" Wood Edge
- 2000 Series hardwood edges
- 3000 Series hardwood edges

	WoodPlus 3 mm PVC	Standard Wood	Detailed Wood	2000 Wood	3000 Wood
Equations	WPES	SWES	RE	2000	1000
Modular 8	WPER	SWER	RA	2001	1100
	WPEN	SWEN	BE	2002	1200
	WPMS	SWMS	TR	2003	2200
	WPMN	SWMN	CL	2004	2100
	WPMP	SWMP			

## ACT Tables

### Racetrack ACT - with Narrow Half Cylinder Base

Description	Model Number	Wgt	List Prices				
			WoodPlus	Standard	Wood Edges		
					Detailed	2000	3000
<b>48" wide</b>	TR4872-ACE-HCN	311	<b>5440</b>	5640	6053	6684	7206
<b>20" wide HC,</b>	TR4884-ACE-HCN	340	<b>5717</b>	5917	6385	7266	7711
<b>18" Dia CYL</b>	TR4896-ACE-HCN	369	<b>6076</b>	6276	6744	7625	8070
	TR48120-ACE-HCN	467	<b>6825</b>	7059	7493	8756	9427

Top: 1 piece; Base: 2 HCN. HCN are 20" diameter plus the 'wedge' on both sides. Includes MO20 ACT electrical outlets and power entry.

TR48144-ACE-HCN	567	<b>7375</b>	7687	8154	9475	10383
TR48150-ACE-HCN	582	<b>7650</b>	7962	8429	9750	10658
TR48168-ACE-HCN	625	<b>8243</b>	8710	9133	10549	11521

Top: 2 piece; Base: 2 HCN, 1 CYL.

HCN are 20" diameter plus the 'wedge' on both sides. Center Cylinder is 18" diameter. Includes MO20 ACT electrical outlets and power entry.

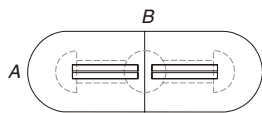
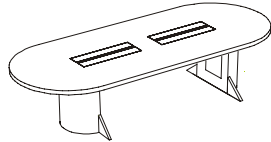

ACT Model Numbers:  
Shape A B ACE Base  
e.g. TB 58 168 ACE RC

<b>58" wide</b>	TR58120-ACE-HCN	509	<b>7096</b>	7330	7764	9027	9698
<b>20" wide HC,</b>	TR58144-ACE-HCN	575	<b>7959</b>	8271	8738	10059	10967
<b>24" Dia CYL</b>	TR58150-ACE-HCN	592	<b>8042</b>	8354	8821	10142	11050

Top: 2 piece; Base: 2 HCN. HCN are 20" diameter plus the 'wedge' on both sides. Includes MO20 ACT electrical outlets and power entry.

TR58168-ACE-HCN	683	<b>8591</b>	9058	9481	10897	11869
TR58180-ACE-HCN	717	<b>10035</b>	10502	10925	12341	13313
TR58192-ACE-HCN	830	<b>10218</b>	10685	11331	12688	13834
TR58216-ACE-HCN	896	<b>10530</b>	10997	11643	13000	14146
TR58240-ACE-HCN	962	<b>11079</b>	11546	12192	13992	15353

Top: 2 piece; Base: 2 HCN, 1 CYL.

HCN are 20" diameter plus the 'wedge' on both sides. Center Cylinder is 18" diameter. Includes MO20 ACT electrical outlets and power entry.

TR58288-ACE-HCN	1217	<b>12152</b>	12548	13710	15569	17273
-----------------	------	--------------	-------	-------	-------	-------

Top: 3 piece; Base: 2 HCN, 2 CYL.

HCN are 20" diameter plus the 'wedge' on both sides. Center Cylinders are 24" diameter. Includes MO20 ACT electrical outlets and power entry.

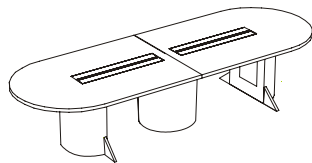

### IMPORTANT: Tables are standard with wood grain running length of table.

#### Finish Colors

Specify ACT table Finish Colors.

For ACT tables table top doors match top finish.

For non-standard top laminates, please contact Customer Service for availability and upcharge.

Optional custom color wood edge is available

#### Notes:

- ACT tables are shipped RTA (ready to assemble)
- MO20 ACT Electrical is included. See overview page for details.
- ACT top doors are shipped installed in the ACT table
- Utility Bay is assembled with electrical included
- one Base Hinged Door (BHD) included with each ACT table It is installed on one of the 'end' base components Additional available as options.

#### Options

Options are built-in at factory

- INLAY -available ONLY with Detailed or larger edge
- INP Black 3mm (1/8") Inlay
- INB Brushed Brass 3mm Inlay or
- INC Satin Chrome 3mm Inlay
- Rectangle top with Bow End or C3R options uses the 'shape inlay' price.

When a Rectangular table top is ordered with 2000 Series edge and an inlay, please add the optional Bow End (BE) or the Corners with 3" Radius (C3R).

#### Options

Options are built-in at factory

- BHD Base Hinged Door first one is included in ACT table in one of the base ends (RC, HC) or in TRI center base
- Additional BHD are available in RC, HC, RHC or in full Cylinder
- For Power source in Center base PE-C1
- Power Entry cables and access door in center base instead of end base.
- See the end of this section for pricing on all options and accessories.

# ACT Tables

## Delta ACT - Radius Cube Base

Description	Model Number	Wgt	List Prices				
			WoodPlus	Standard	Detailed	2000	3000
<b>One piece top</b>	TDE5896-ACE-RC	462	<b>7320</b>	7554	7988	9251	9922
	TDE58120-ACE-RC	529	<b>8056</b>	8290	8724	9987	10658
Top: 1 piece; Base: 2 RC. Includes MO20 ACT electrical outlets and power entry.							
<b>Two piece top two bases</b>	TDE58144-ACE-RC	635	<b>9004</b>	9316	9783	11104	12012
	TDE58150-ACE-RC	652	<b>9096</b>	9408	9875	11196	12104
Top: 2 piece; Base: 2 RC. Includes MO20 ACT electrical outlets and power entry.							
<b>Two piece top three bases</b>	TDE58168-ACE-RC	773	<b>10154</b>	10621	11044	12460	13432
	TDE58180-ACE-RC	807	<b>10740</b>	11207	11630	13046	14018
	TDE58192-ACE-RC	840	<b>11472</b>	11939	12585	13942	15088
	TDE58216-ACE-RC	986	<b>11809</b>	12276	12922	14279	15425

Top: 2 piece; Base: 3 RC. Includes MO20 ACT electrical outlets and power entry.

Power entry is standard from the wide end of the table.

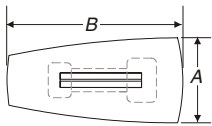
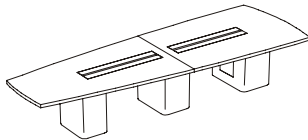
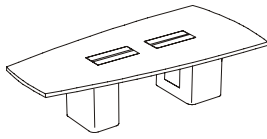

ACT Model Numbers:  
Shape A B ACE Base  
e.g. TDE 58 120 ACE RC

## Egg Shape ACT - Radius Half Cylinder Base

<b>One piece top</b>	TEG5896-ACE-RHC	462	<b>8011</b>	8245	8679	9942	10613
----------------------	-----------------	-----	-------------	------	------	------	-------

Top: 1 piece; Base: 2 RHC. Includes MO20 ACT electrical outlets and power entry.

Power entry is standard from the wide end of the table.

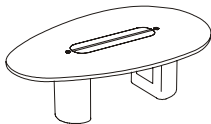

TEG5896-ACE-RHC

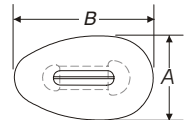

ACT Model Numbers:  
Shape A B ACE Base  
e.g. TEG 58 96 ACE RHC

**IMPORTANT: Tables are standard with wood grain running length of table.**

### Finish Colors

Specify ACT table Finish Colors.

For ACT tables table top doors match top finish.

For non-standard top laminates, please contact Customer Service for availability and upcharge.

Custom color wood edge on outside of table

See the end of this section for pricing on all options and accessories.

### Edge Options Information

- ACT tables are available with the following edge options:
- WoodPlus 3 mm PVC edge
  - Standard 3 mm Wood Edge
  - Detailed 3/8" Wood Edge
  - 2000 Series hardwood edges
  - 3000 Series hardwood edges

WoodPlus 3 mm PVC	Standard Wood	Detailed Wood	2000 Wood	3000 Wood
Equations WPES	Equations SWES	RE	2000	1000
Modular 8 WPER	Modular 8 SWER	RA	2001	1100
WPMS	SWMS	BE	2002	1200
WPEN	SWEN	TR	2003	2200
WPMN	SWMN	CL	2004	2100
WPMP	SWMP			



## ACT Tables

### Round ACT - Full Cylinder Base

Description	Model Number	Wgt	List Prices				
			WoodPlus	Standard	Wood Edges		
					Detailed	2000	3000
<b>58" Diameter</b>	TD58-ACE-CYL	220	<b>6076</b>	6276	6744	7625	8070

One piece top. Includes MO20 ACT electrical outlets and power entry.

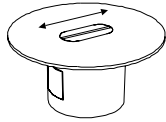

TD58-ACE-CYL

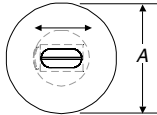

ACT Model Numbers:  
Shape A ACE Base  
e.g. TD 58 ACE CYL

<b>66" and 72" Diameter</b>	TD66-ACE-CYL	255	<b>7375</b>	7687	8154	9475	10383
	TD72-ACE-CYL	310	<b>7375</b>	7687	8154	9475	10383

Two piece tops. Includes MO20 ACT electrical outlets and power entry.

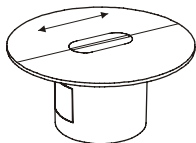

TD66-ACE-CYL or  
TD72-ACE-CYL

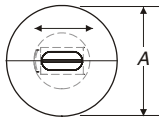

ACT Model Numbers:  
Shape A ACE Base  
e.g. TD 72 ACE CYL

**IMPORTANT: Tables are standard with wood grain running length of table.**

#### Finish Colors

Specify ACT table Finish Colors.

For ACT tables table top doors match top finish.

For non-standard top laminates, please contact Customer Service for availability and upcharge.

Optional custom color wood edge is available

#### Notes:

- ACT tables are shipped RTA (ready to assemble)
- MO20 ACT Electrical is included. See overview page for details.
- ACT top doors are shipped installed in the ACT table top
- Utility Bay is assembled with electrical included
- one Base Hinged Door (BHD) included with each ACT table It is installed on one of the 'end' base components Additional available as options.

#### Options

Options are built-in at factory

- INLAY -available ONLY with Detailed or larger edge
- INP Black 3mm (1/8") Inlay
- INB Brushed Brass 3mm Inlay or
- INC Satin Chrome 3mm Inlay
- Rectangle top with Bow End or C3R options uses the 'shape inlay' price.
- When a Rectangular table top is ordered with 2000 Series edge and an inlay, please add the optional Bow End (BE) or the Corners with 3" Radius (C3R).

#### Options

Options are built-in at factory

- BHD Base Hinged Door first one is included in ACT table in one of the base ends (RC, HC) or in TRI center base
- Additional BHD are available in RC, HC, RHC or in full Cylinder
- For Power source in Center base PE-C1
- Power Entry cables and access door in center base instead of end base.
- See the end of this section for pricing on all options and accessories.

# ACT Tables

## Wing Table ACT - Radius Cube Base

Description	Model Number	Wgt	List Prices				
			WoodPlus	Standard	Detailed	Wood Edges	
				2000	2002	2003	2004
<b>ACT WING table</b>	TW-1712-ACE-RC	<b>19975</b>	20910	21978	24915	27207	

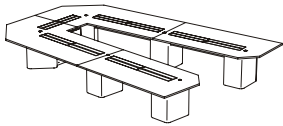

WING table seats 16.  
 Table is 16' - 10" long by 12' - 3" wide  
 Minimum room size is 25' long by 20' wide.

Power entry location is shown below.  
 As shown, the WING table has the following:  
 14 electrical duplex outlets  
 15 faceplate bezels

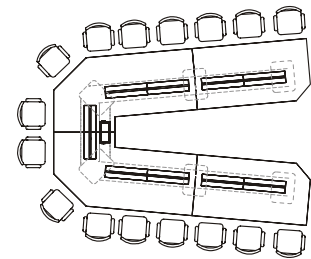
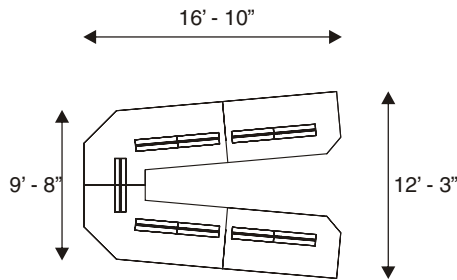
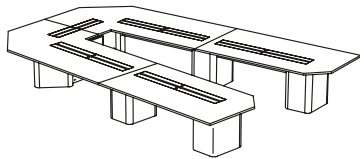

Seats 16 at table

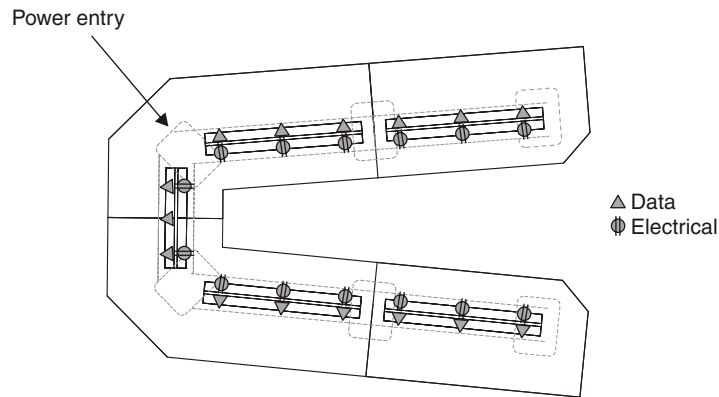

**IMPORTANT: Tables are standard with wood grain running length of table.**

### Finish Colors

Specify ACT table Finish Colors.

For ACT tables table top doors match top finish.

For non-standard top laminates, please contact Customer Service for availability and upcharge.

Custom color wood edge on outside of table

See the end of this section for pricing on all options and accessories.

### Edge Options Information

- ACT tables are available with the following edge options:
- WoodPlus 3 mm PVC edge
  - Standard 3 mm Wood Edge
  - Detailed 3/8" Wood Edge
  - 2000 Series hardwood edges
  - 3000 Series hardwood edges

WoodPlus 3 mm PVC	Standard Wood	Detailed Wood	2000 Wood	3000 Wood
Equations WPES	Equations SWES	RE	2000	1000
Modular 8 WPER	Modular 8 SWER	RA	2001	1100
WPMS	SWMS	BE	2002	1200
WPEN	SWEN	TR	2003	2200
WPMN	SWMN	CL	2004	2100
WPMP	SWMP			



## ACT Tables - WoodPlus<sup>2</sup>

Description	Model No.	Overall Dimensions		Wgt	List Prices WoodPlus <sup>2</sup>
		Wide	Long		

### ACT WoodPlus<sup>2</sup> Rectangular Bow End with Radius Cube Base

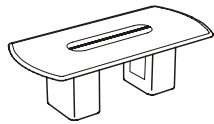

TT-BE-4696-ACE-RC

<b>42" wide,</b>	TT-BE-4272-ACE-RC-WP2	42	72	321	<b>4854</b>
<b>One Piece Top</b>	TT-BE-4284-ACE-RC-WP2	42	84	350	<b>5387</b>
	TT-BE-4296-ACE-RC-WP2	42	96	379	<b>5760</b>

Top: 1 piece; Base: 2 Radius Cubes. Includes MO20 ACT electrical outlets.  
Power Entry (one per utility bay side) and BHD Base Hinged Door included at one end.

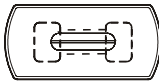

<b>Two Piece Top</b>	TT-BE-42120-ACE-RC-WP2	42	120	467	<b>6918</b>
----------------------	------------------------	----	-----	-----	-------------

Top: 2 piece; Base: 2 Radius Cubes. Includes MO20 ACT electrical outlets.  
Power Entry (one per utility bay side) and BHD Base Hinged Door included at one end.

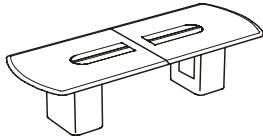

TT-BE-46120-ACE-RC

	TT-BE-42144-ACE-RC-WP2	42	144	577	<b>8315</b>
	TT-BE-42150-ACE-RC-WP2	42	150	592	<b>9145</b>
	TT-BE-42168-ACE-RC-WP2	42	168	630	<b>10954</b>

Top: 2 piece; Base: 3 Radius Cubes. Includes MO20 ACT electrical outlets.  
Power Entry (one per utility bay side) and BHD Base Hinged Door included at one end.

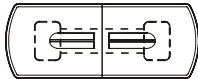

<b>46" wide,</b>	TT-BE-4672-ACE-RC-WP2	46	72	331	<b>4854</b>
<b>One Piece Top</b>	TT-BE-4684-ACE-RC-WP2	46	84	360	<b>5387</b>
	TT-BE-4696-ACE-RC-WP2	46	96	389	<b>5760</b>

Top: 1 piece; Base: 2 Radius Cubes. Includes MO20 ACT electrical outlets.  
Power Entry (one per utility bay side) and BHD Base Hinged Door included at one end.

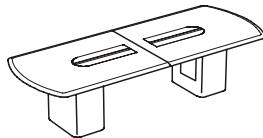

TT-BE-46120-ACE-RC

<b>Two Piece Top</b>	TT-BE-46120-ACE-RC-WP2	46	120	487	<b>6918</b>
----------------------	------------------------	----	-----	-----	-------------

Top: 2 piece; Base: 2 Radius Cubes. Includes MO20 ACT electrical outlets.  
BHD Base Hinged Door included at one base end component.

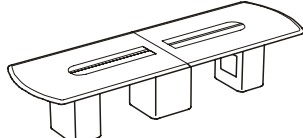

TT-BE-46144-ACE-RC

	TT-BE-46144-ACE-RC-WP2	46	144	597	<b>8315</b>
	TT-BE-46150-ACE-RC-WP2	46	150	612	<b>9145</b>
	TT-BE-46168-ACE-RC-WP2	46	168	655	<b>10954</b>

Top: 2 piece; Base: 3 Radius Cubes. Includes MO20 ACT electrical outlets.  
Power Entry (one per utility bay side) and BHD Base Hinged Door included at one end.

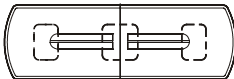

**IMPORTANT: Tables are standard with wood grain running length of table.**

#### Order information:

Qty	Model Number	Top finish	Base finish	Option
1	TR-46120-ACE-HC-WP2	WP2-31	WP2-31	
1	TB-BE-42120-ACE-RC-WP2	WP2-81	CP2-88	
2	TB-BE-46168-ACE-RC-WP2	CP2-28	WP2-71	
1	TWE-4672-ACE-RC-WP2	WP2-61	CP2-88	
2	TR-42144-ACE-HC-WP2	CP2-38	CP2-88	
1	7128	WP2-41	CP2-88	

#### Notes

Tables are shipped  
RTA (ready to assemble)

#### Important:

**WoodPlus<sup>2</sup> Conference Tables are standard with wood grain running length of table.**

#### Electrical Packages

ACT WoodPlus<sup>2</sup> Tables include MO20  
Electrical Package appropriate for Table size.  
Electrician required to hardwire ACT electrical  
to building power.

## ACT Tables - WoodPlus<sup>2</sup>

Description	Model No.	Overall Dimensions		Wgt	List Prices WoodPlus <sup>2</sup>
		Wide	Long		

### ACT WoodPlus<sup>2</sup> Boat Bow End with Radius Cube Base

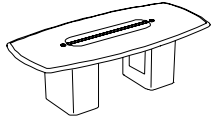

TB-BE-4296-ACE-RC

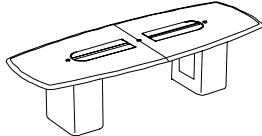
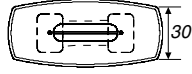

TB-BE-42120-ACE-RC

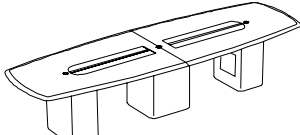

TB-BE-42144-ACE-RC

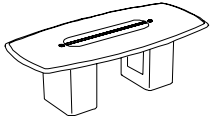

TB-BE-4696-ACE-RC

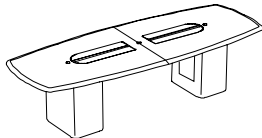

TB-BE-46120-ACE-RC

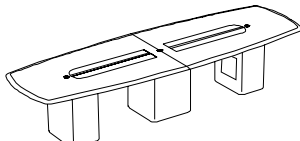

TB-BE-46144-RC



<b>42" wide, One Piece Top</b>	TB-BE-4272-ACE-RC-WP2	42	72	321	<b>4854</b>
	TB-BE-4284-ACE-RC-WP2	42	84	350	<b>5387</b>
	TB-BE-4296-ACE-RC-WP2	42	96	379	<b>5760</b>

Top: 1 piece; Base: 2 Radius Cubes. Includes MO20 ACT electrical outlets.  
Power Entry (one per utility bay side) and BHD Base Hinged Door included at one end.

<b>Two Piece Top</b>	TB-BE-42120-ACE-RC-WP2	42	120	467	<b>6918</b>
----------------------	------------------------	----	-----	-----	-------------

Top: 2 piece; Base: 2 Radius Cubes. Includes MO20 ACT electrical outlets.  
Power Entry (one per utility bay side) and BHD Base Hinged Door included at one end.

	TB-BE-42144-ACE-RC-WP2	42	144	577	<b>8315</b>
	TB-BE-42150-ACE-RC-WP2	42	150	592	<b>9145</b>
	TB-BE-42168-ACE-RC-WP2	42	168	630	<b>10954</b>

Top: 2 piece; Base: 3 Radius Cubes. Includes MO20 ACT electrical outlets.  
Power Entry (one per utility bay side) and BHD Base Hinged Door included at one end.

<b>46" wide, One Piece Top</b>	TB-BE-4672-ACE-RC-WP2	46	72	331	<b>4854</b>
	TB-BE-4684-ACE-RC-WP2	46	84	360	<b>5387</b>
	TB-BE-4696-ACE-RC-WP2	46	96	389	<b>5760</b>

Top: 1 piece; Base: 2 Radius Cubes. Includes MO20 ACT electrical outlets.  
Power Entry (one per utility bay side) and BHD Base Hinged Door included at one end.

<b>Two Piece Top</b>	TB-BE-46120-ACE-RC-WP2	46	120	487	<b>6918</b>
----------------------	------------------------	----	-----	-----	-------------

Top: 2 piece; Base: 2 Radius Cubes. Includes MO20 ACT electrical outlets.  
BHD Base Hinged Door included at one base end component.

	TB-BE-46144-ACE-RC-WP2	46	144	597	<b>8315</b>
	TB-BE-46150-ACE-RC-WP2	46	150	612	<b>9145</b>
	TB-BE-46168-ACE-RC-WP2	46	168	655	<b>10954</b>

Top: 2 piece; Base: 3 Radius Cubes. Includes MO20 ACT electrical outlets.  
Power Entry (one per utility bay side) and BHD Base Hinged Door included at one end.

**IMPORTANT: Tables are standard with wood grain running length of table.**

#### WoodPlus<sup>2</sup> ACT Table Top Finishes

WP2-41 Natural Maple  
WP2-81 Fusion Maple  
WP2-45 Anigre  
WP2-61 Pear  
WP2-31 Medium Cherry  
WP2-71 Dark Cherry  
CP2-28 Medium Grey Speckle  
CP2-38 Beige Speckle

#### WoodPlus<sup>2</sup> XTRA tops only (see upcharges)

WP2-18 Shadow Oak  
WP2-65 Beech  
WP2-75 Port  
CP2-72 Shark Gray  
CP2-78 Bronze  
CP2-80 Cashmere Fiber

#### WoodPlus<sup>2</sup> ACT Table base Finishes

WP2-41 Natural Maple  
WP2-81 Fusion Maple  
WP2-45 Anigre  
WP2-61 Pear  
WP2-31 Medium Cherry  
WP2-71 Dark Cherry  
CP2-88 Black  
CP2-98 Slate  
CP2-76 Espresso

#### TABLE EDGES WOODPLUS<sup>2</sup> or COLORPLUS<sup>2</sup>

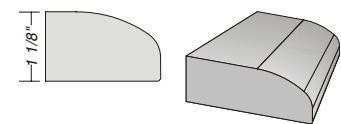

## ACT Tables - WoodPlus<sup>2</sup>

Description	Model No.	Overall Dimensions		Wgt	List Prices WoodPlus <sup>2</sup>
		Wide	Long		

### ACT WoodPlus<sup>2</sup> Racetrack with Half Cylinder Base



TR-4296-ACE-HC

<b>42" wide, One Piece Top</b>	TR-4272-ACE-HC-WP2	42	72	321	<b>4026</b>
	TR-4284-ACE-HC-WP2	42	84	350	<b>4590</b>
	TR-4296-ACE-HC-WP2	42	96	379	<b>4933</b>

Top: 1 piece; Base: 2 Half Cylinders. Includes MO20 ACT electrical outlets. Power Entry (one per utility bay side) and BHD Base Hinged Door included at one end.

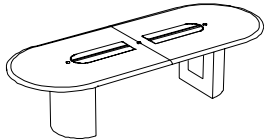

TR-42120-ACE-HC

<b>Two Piece Top</b>	TR-42120-ACE-HC-WP2	42	120	467	<b>6090</b>
----------------------	---------------------	----	-----	-----	-------------

Top: 2 piece; Base: 2 Half Cylinders. Includes MO20 ACT electrical outlets. Power Entry (one per utility bay side) and BHD Base Hinged Door included at one end.

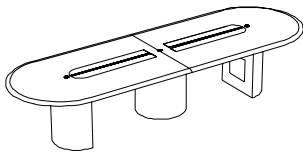

TR-42144-ACE-HC

	TR-42144-ACE-HC-WP2	42	144	577	<b>6725</b>
	TR-42150-ACE-HC-WP2	42	150	592	<b>8208</b>
	TR-42168-ACE-HC-WP2	42	168	630	<b>10019</b>

Top: 2 piece; Base: 2 Half Cylinders, 1 Full Cylinder. Includes MO20 ACT electrical outlets. Power Entry (one per utility bay side) and BHD Base Hinged Door included at one end.



TR-4696-ACE-HC

<b>46" wide, One Piece Top</b>	TR-4672-ACE-HC-WP2	46	72	311	<b>4026</b>
	TR-4684-ACE-HC-WP2	46	84	340	<b>4590</b>
	TR-4696-ACE-HC-WP2	46	96	369	<b>4933</b>

Top: 1 piece; Base: 2 Half Cylinders. Includes MO20 ACT electrical outlets. Power Entry (one per utility bay side) and BHD Base Hinged Door included at one end. Note: RHC base option not available on TR-4672-ACE-HC-WP2 table.

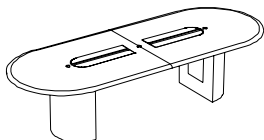

TR-46120-ACE-HC

<b>Two Piece Top</b>	TR-46120-ACE-HC-WP2	46	120	467	<b>5746</b>
----------------------	---------------------	----	-----	-----	-------------

Top: 2 piece; Base: 2 Half Cylinders. Includes MO20 ACT electrical outlets. Power Entry (one per utility bay side) and BHD Base Hinged Door included at one end.

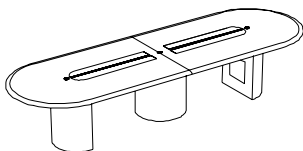

TR-46144-ACE-HC

	TR-46144-ACE-HC-WP2	46	144	567	<b>7128</b>
	TR-46150-ACE-HC-WP2	46	150	582	<b>8208</b>
	TR-46168-ACE-HC-WP2	46	168	625	<b>10019</b>

Top: 2 piece; Base: 2 Half Cylinders, 1 Full Cylinder. Includes MO20 ACT electrical outlets.

Power Entry (one per utility bay side) and BHD Base Hinged Door included at one end.

### ACT WoodPlus<sup>2</sup> 'Egg' with Radius Half Cylinder Base



<b>46" wide, One Piece Top</b>	TEG-4676-ACE-RHC-WP2	46	76	462	<b>4356</b>
------------------------------------	----------------------	----	----	-----	-------------

Top: 1 piece; Base: 2 Radius Half Cylinders. Includes MO20 ACT electrical outlets. Power Entry (one per utility bay side) and BHD Base Hinged Door included at 'large' end.

**IMPORTANT: Tables are standard with wood grain running length of table.**

#### Order information:

Qty	Model Number	Top finish	Base finish	Option
1	TR-46120-ACE-HC-WP2	WP2-31	WP2-31	
1	TB-BE-42120-ACE-RC-WP2	WP2-81	CP2-88	
2	TB-BE-46168-ACE-RC-WP2	CP2-28	WP2-71	
1	TWE-4672-ACE-RC-WP2	WP2-61	CP2-88	
2	TR-42144-ACE-HC-WP2	CP2-38	CP2-88	
1	7128	WP2-41	CP2-88	

#### Notes

Tables are shipped RTA (ready to assemble)

#### Important:

**WoodPlus<sup>2</sup> Conference Tables are standard with wood grain running length of table.**

#### Electrical Packages

ACT WoodPlus<sup>2</sup> Tables include MO20 Electrical Package appropriate for Table size. Electrician required to hardwire ACT electrical to building power.

## ACT Table Options - WoodPlus and WoodPlus<sup>2</sup>

Description	Model No.	Overall Dimensions		Wgt	List Prices
		Long	Deep		

### ACT Inlay Options - only available on WoodPlus table tops

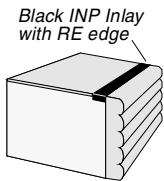

Black INP Inlay with RE edge

<b>Black, Rectangular</b>	CMR-INLAY-RECT-ALL-BLACK	<b>413</b>
---------------------------	--------------------------	------------

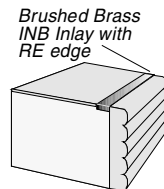

Brushed Brass INB Inlay with RE edge

<b>Black, Shaped</b>	CMR-INLAY-SHAPE-ALL-BLACK	<b>712</b>
----------------------	---------------------------	------------

<b>Brass, Rectangular</b>	CMR-INLAY-RECT-ALL-BRASS	<b>826</b>
---------------------------	--------------------------	------------

<b>Brass, Shaped</b>	CMR-INLAY-SHAPE-ALL-BRASS	<b>1409</b>
----------------------	---------------------------	-------------

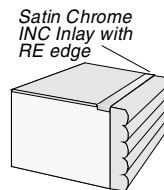

Satin Chrome INC Inlay with RE edge

<b>Chrome, Rectangular</b>	CMR-INLAY-RECT-ALL-CHROME	<b>826</b>
----------------------------	---------------------------	------------

<b>Chrome, Shaped</b>	CMR-INLAY-SHAPE-ALL-CHROME	<b>1409</b>
-----------------------	----------------------------	-------------

### Radius Corners added to a Table top - only available on WoodPlus table tops

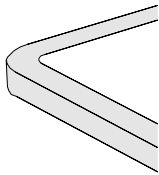

<b>Add Radius</b>	Top-C3R-WPE	<b>412</b>
<b>Corners</b>	Top-C3R-STD	<b>412</b>
	Top-C3R-DET	<b>594</b>
	Top-C3R-2000	<b>840</b>
	Top-C3R-3000	<b>840</b>

3 radius on the inside of the edge. To order add '-C3R' to the end of the table model. Rectangular top with Radius corners uses the the Shaped top INLAY upcharge.

### Adding Bow Ends to a Rectangular or Boat Shaped Table - only available on WoodPlus table tops

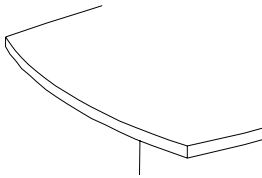

<b>Add Bow Ends</b>	Top-BE-WPE	<b>283</b>
	Top-BE-STD	<b>283</b>
	Top-BE-DET	<b>283</b>
	Top-BE-2000	<b>283</b>
	Top-BE-3000	<b>283</b>

To order add '-BE' to the end of the table model number. Rectangular top with Bow End uses the Shaped top INLAY charge.

### Flat Screen storage in base - available on tables 48" or wider

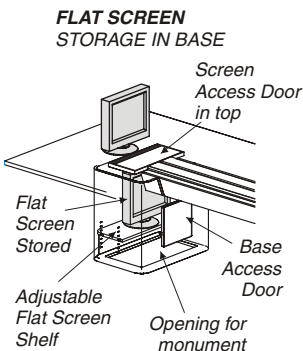

<b>Storage for flatscreen</b>	ACT-FLATSCR-STORAGE	<b>401</b>
-------------------------------	---------------------	------------

Use of this option requires a 48" minimum table width. Adds a door in the top and a shelf in the base below to store a flatscreen monitor when not in use. Please specify actual dimensions of flatscreen to be stored.

For example, on 48" wide table with the full RC Radius Cube base, the door in the table top is 11" long (the length of the table) and 21" wide (width of the table). Maximum height is 26".

## ACT Table Options - WoodPlus and WoodPlus<sup>2</sup>

Description	Model No.	Overall Dimensions		Wgt	List Prices
		Long	Deep		

### **Base Options - available on all tables using these bases**

Base Hinged Doors

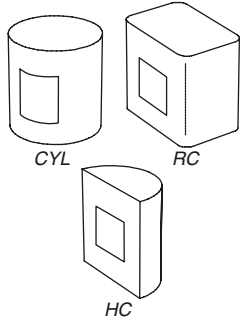

<b>Base Hinged Door</b>	BHD-RC	<b>145</b>
	BHD-HC	<b>145</b>
	BHD-RHC	<b>145</b>
	BHD-CYL	<b>308</b>

To order Base Hinged Doors add to end of the model number  
 BHD-RC on Radius Cube, BHD-HC on Half Cylinder, BHD-RHC on Radius Half Cylinder,  
 BHD-CYL on full Cylinder (used in CYL bases or as the center base on TR...HC tables).

<b>Base wire notch</b>	NU-BASE-NOTCH-UPPER	<b>97</b>
------------------------	---------------------	-----------

Notches in both sides of the top edge of the all bases.

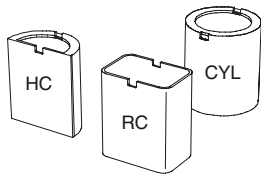

NU Base Notch option for wire pass through (includes each base of table)

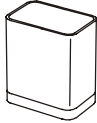

<b>Base Silver Accent</b>	BASE-SILVER-ACCENT-1	<b>164</b>
	BASE-SILVER-ACCENT-2	<b>328</b>
	BASE-SILVER-ACCENT-3	<b>492</b>
	BASE-SILVER-ACCENT-4	<b>657</b>

Add the 3" silver accent strip to the bottom of each table base: HC, CYL, RC.

<b>Base Black Accent</b>	BASE-BLACK-ACCENT-1	<b>111</b>
	BASE-BLACK-ACCENT-2	<b>222</b>
	BASE-BLACK-ACCENT-3	<b>333</b>
	BASE-BLACK-ACCENT-4	<b>445</b>

Add the 3" black accent strip to the bottom of each table base: HC, CYL, RC.

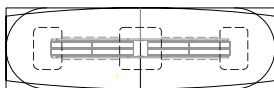

Power entry is supplied at one end of the table. To locate the power entry below the center base use the PEC option

<b>Power Entry in center base</b>	ACT-POWER-ENTRY-CENTER	<b>316</b>
-----------------------------------	------------------------	------------

Move the power entry to the center base.

Power entry is supplied at one end of the table. To locate the power entry below the center base, use this option and add the suffix PEC to the model number.

<b>PLUG END power option on ACT tables</b>	<p>In the ACT TABLE OVERVIEW section of this pricelist, immediately after the ACT TABLE MO20 ELECTRICAL PACKAGE pages, the OPTIONAL PLUG END ELECTRICAL FOR ACT TABLES is priced.</p>	
--	---	--

This option replaces the powerstrips that require hardwiring by an electrician to the building's power supply with powerstrips that have a PLUG END and can be plugged directly into a standard three prong outlet.

These PLUG END powerstrips are UL Labeled.

The MO20 hardwired powerstrips are 20 amp circuits with 15 amp outlets.  
 The PLUG END powerstrips are 15 amp circuits with 15 amp outlets.

## ACT Table Options - WoodPlus and WoodPlus<sup>2</sup>

Description	Model No.	Overall Dimensions		Wgt	List Prices
		Long	Deep		

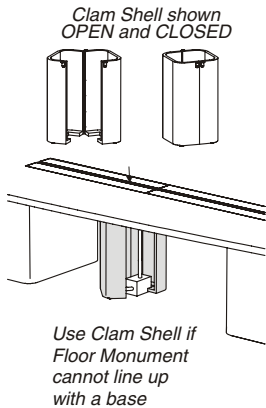

<b>Clam shell base</b>	<b>BASE-CLAM-ACT</b>				<b>645</b>
------------------------	----------------------	--	--	--	------------

Size is 12 by 12 and fits between the floor and the bottom of the ACT table utility bay.  
This is not a structural unit.  
Use the clam shell base to protect and hide wiring when the power / wiring access is not located at a table base

### Add equipment rack to RC base

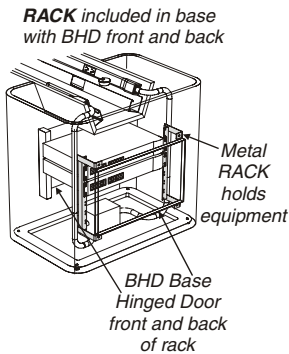

<b>Equipment Rack</b>	<b>BASE-RACK-RAILS</b>				<b>736</b>
-----------------------	------------------------	--	--	--	------------

Use of this option requires a 48" minimum table width.  
Includes pair of Rack Rails mounted to the table base  
locking doors on both sides of the base,  
vents on both sides of the base  
Rack Rails are 10 space 17.5 high, mounted on the inside of the base.  
Will fit in a RC Radius Cube base on a 58" wide table such as  
TT Rectangle,  
TB Boat shaped,  
TDE Delta (large end only).  
The end base has 18.5" clear inside front to back, center base has 28.5" clear front to back.  
Note that the CENTER location includes a cord access opening in the utility bay.  
Please contact Customer Service for requirements to install on other bases.

### Add CPU storage to RC or CYL base

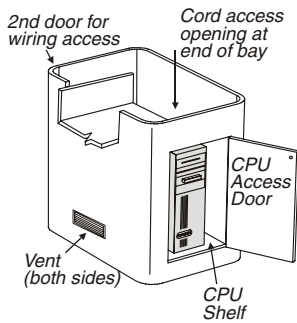

<b>CPU storage in RC base</b>	<b>BASE-CPU-STORAGE-RC</b>				<b>623</b>
-------------------------------	----------------------------	--	--	--	------------

For an RC base used on TT, TB, TDE tables.  
Adds a fixed shelf, two doors (one for CPU and one for wiring access), doors locks, vents.  
Specify location of the CPU STORAGE as END or CENTER.  
Note that the CENTER location includes a cord access opening in the utility bay.

Table width	base location	door opening	depth	
42 wide table	center RC	18 by 18	10 by 19	16.5 including connections
46 wide table	end RC	14 by 20	6 by 19	18.5 including connections
	center RC	20 by 20	12 by 19	18.5 including connections
48 wide table	end RC	16 by 24	8 by 19	22.5 including connections
	center RC	24 by 24	12 by 19	22.5 including connections
58 wide table	end RC	20 by 30	12 by 19	28.5 including connections
	center RC	30 by 30	12 by 19	28.5 including connections

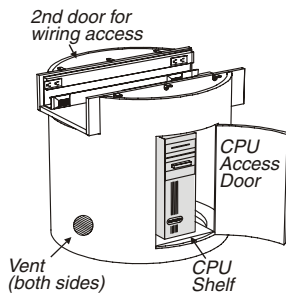

<b>CPU storage in CYL base</b>	<b>BASE-CPU-STORAGE-CYL</b>				<b>950</b>
--------------------------------	-----------------------------	--	--	--	------------

For a CYL Cylinder base used on TR tables.  
Adds a fixed shelf, two doors (one for CPU and one for wiring access), doors locks, vents.  
Specify location of the CPU STORAGE as CENTER.  
Note that the CENTER location includes a cord access opening in the utility bay.

Table width	base location	door	opening	depth
42 wide table	center CYL	18 by 18	8.5 by 17.5	16.5 including connections
46 wide table	center CYL	20 by 20	9.4 by 17.5	18.5 including connections
48 wide table	center CYL	24 by 24	11.3 by 19	22.5 including connections
58 wide table	center CYL	30 by 30	11.5 by 19	28.5 including connections

## ACT Table Options - WoodPlus and WoodPlus<sup>2</sup>

Description	Model No.	Overall Dimensions		Wgt	List Prices
		Long	Deep		

### Add polycom storage to ACT table

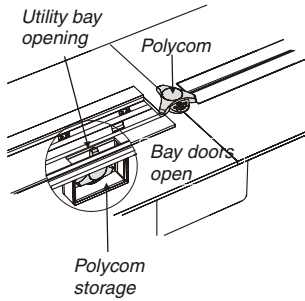

<b>Storage for polycom</b>	ACT-POLYCOM-STORAGE				<b>350</b>
	Adds a storage slot in the bottom of the utility bay to hold a polycom. Please specify the overall size and shape of the polycom unit.				

### INSERTS for Bezels with connector for ACT and KAIZEN tables

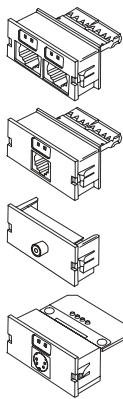

<b>Category 6</b>	INSERT-2A-145-CC6-BK				<b>27</b>
	INSERT-2A-245-CC6-BK				<b>54</b>
<b>Category 5e</b>	INSERT-2A-145-C5EU-BK				<b>17</b>
	INSERT-2A-245-C5EU-BK				<b>30</b>
<b>Phone Jack</b>	INSERT-2A112-U2-BK				<b>15</b>
<b>USOC wiring</b>	INSERT-2A212-U2-BK				<b>23</b>
<b>Audio</b>	INSERT-2A-1RCA-BK				<b>18</b>
<b>Video</b>	INSERT-2A-1SVHS-BK				<b>36</b>

<b>Bezels</b>	BEZEL-CUTOUT				<b>38</b>
---------------	--------------	--	--	--	-----------

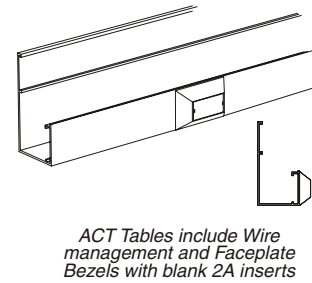
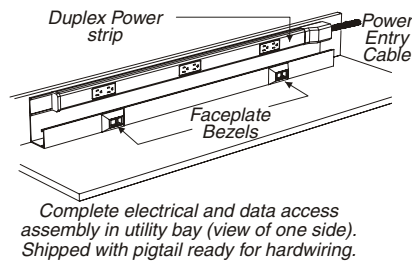
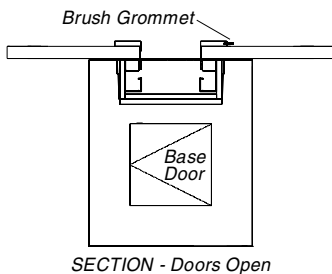

**ACT** and **TKZ KAIZEN** tables are shipped with blank inserts in all of the bezels.

The above INSERTS with the connector already installed in it, may be ordered separately and shipped with your table.

The number of bezels varies by the size and type of table, please refer to the beginning of the ACT table section or the TKZ Kaizen table section.

Other INSERTS are available from Pass & Seymour on the web at <http://passandseymour.com>.

More INSERT links are available on our website at <http://www.magnadesign.com/inserts.html>

# MINI-ACT Tables

## Comparison of MINI-ACT flexibility and ACT table capacity, example 1:

In this example, we compare a Boat shaped conference table at 58 deep and 192 long (4' 10" by 16').

In Specification 1 we install two of the MINI-ACT-3-4-JPLUG units that plug into floor outlets, two Base Hinged Doors, with a total of six outlets and eight data openings.

In Specification 2 we install three MINI-ACT-3-4, one STARTER and two ADDER, that are hardwired to the building power, one Base Hinged Door and the wiremanager V-BAY (two sections, one between each pair of bases) with a total of nine outlets and twelve data openings.

In Specification 3 we use an ACT table which includes the MO20 power that is hardwired to the building power, the Utility bay for wiremanager and storage, one Base Hinged Door, and a total of twenty-four outlets and twelve data openings.

### Specification 1: J-Plug Mini-Act units

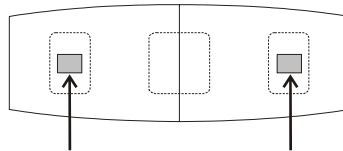
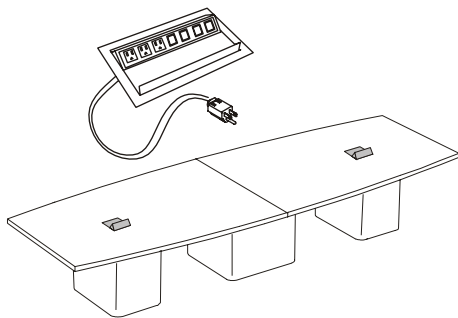

#### SPECIFICATIONS:

Table shape	Boat top conference table
Table base	Radius Cube bases
Power / data info	Base Hinged Doors (2) Mini-Act 3-4-JPLUG (2)
Electrical	J-Plug
Outlets	six
Data openings	eight

### Specification 2: Hardwired Mini-Act units with V-Bay

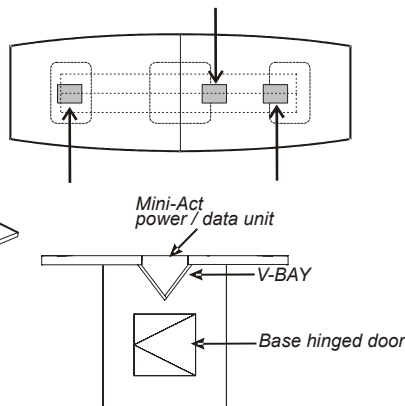
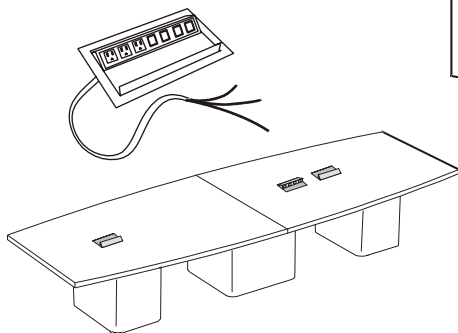

#### SPECIFICATIONS:

Table shape	Boat top conference table
Table base	Radius Cube bases
Power / data info	Base Hinged Doors (1) Mini-Act 3-4-Starter (1) Mini-Act 3-4-Adder (2)
Wire management:	V-Bay in two sections
Electrical	Hardwired
Outlets	nine
Data openings	twelve

### Specification 3: ACT table with hardwired power and Utility Bay

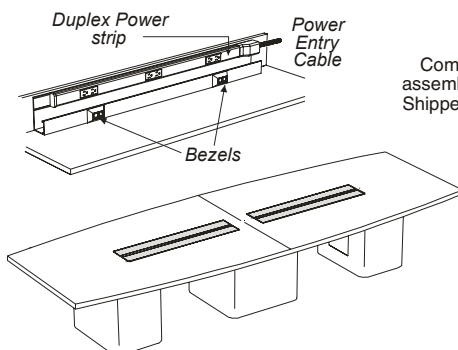

Complete electrical and data access assembly in utility bay (view of one side). Shipped with pigtail ready for hardwiring.

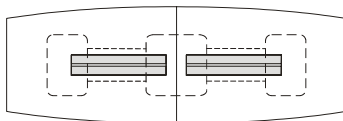

#### SPECIFICATIONS:

Table shape	Boat top ACT table
Table base	Radius Cube bases
Power / data info	Base Hinged Doors (1) MO20 power ACT table data
Wire management:	ACT U-Bay included and storage area
Electrical	Hardwired
Outlets	twenty-four
Data openings	twelve



## MINI-ACT Tables

### Comparison of MINI-ACT flexibility and ACT table capacity, example 2:

In this example, we compare a Delta shaped conference table at 58 deep and 120 long (4' 10" by 10').

In Specification 1 we install one of the MINI-ACT-3-4-JPLUG units that plug into floor outlets, one Base Hinged Door, with a total of three outlets and four data openings.

In Specification 2 we install two MINI-ACT-3-4, one STARTER and one ADDER, that are hardwired to the building power, one Base Hinged Door and the wiremanager V-BAY (one sections, one between each pair of bases) with a total of six outlets and eight data openings.

In Specification 3 we use an ACT table which includes the MO20 power that is hardwired to the building power, the Utility bay for wiremanager and storage, one Base Hinged Door, and a total of sixteen outlets and eight data openings.

#### Specification 1: J-Plug Mini-Act units

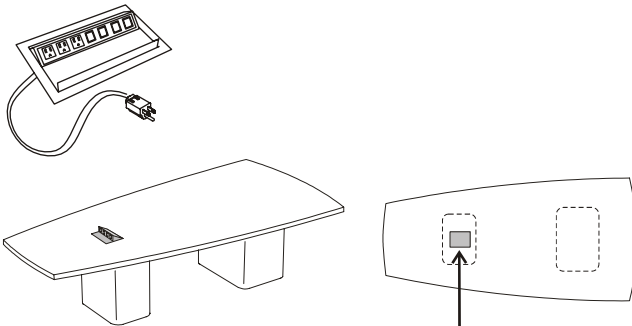

#### SPECIFICATIONS:

Table shape	Delta top conference table
Table base	Radius Cube bases
Power / data info	Base Hinged Doors (1) Mini-Act 3-4-JPLUG (1)
Electrical	J-Plug
Outlets	three
Data openings	four

#### Specification 2: Hardwired Mini-Act units with V-Bay

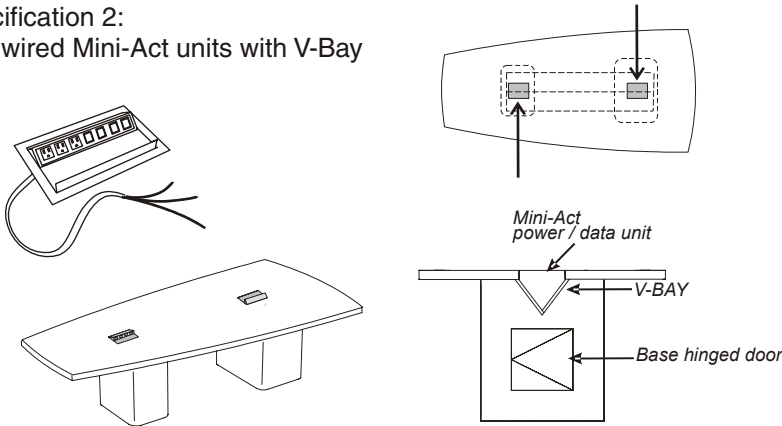

#### SPECIFICATIONS:

Table shape	Delta top conference table
Table base	Radius Cube bases
Power / data info	Base Hinged Doors (1) Mini-Act 3-4-Starter (1) Mini-Act 3-4-Adder (1)
Wire management:	V-Bay included
Electrical	Hardwired
Outlets	six
Data openings	eight

#### Specification 3: ACT table with hardwired power and Utility Bay

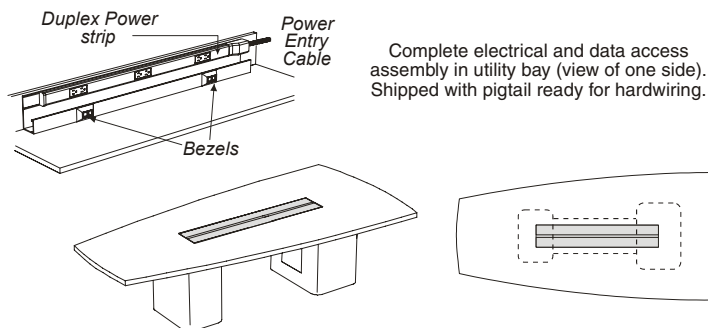

#### SPECIFICATIONS:

Table shape	Delta top ACT table
Table base	Radius Cube bases
Power / data info	Base Hinged Doors (1) MO20 power ACT table data
Wire management:	ACT U-Bay included and storage area
Electrical	Hardwired
Outlets	sixteen
Data openings	eight

## MINI-ACT Tables

### Example: setting up the MINI-ACT table:

- 1) Choose the table and accessories to fit your space. Pages 9 through 13 have seating capacity and layout guidelines.
- 2) Determine your table top power and data requirements, then choose and locate the power / data units to be included

MINI-ACT-2-2.... Power - data unit includes two outlets and two data connection ports with adapters



MINI-ACT-3-4.... Power - data unit includes three outlets and four data connection ports with adapters



- 3) For easy access to a floor monument, include the optional BHD Base Hinged Door on the base located over the monument.
- 4) If the power / data unit is not located over a table base with floor monument, you may keep all of the wiring off of the floor by using either the V-BAY wiremanager or two facing MJT wiremanagers and notches in the tops of the table bases.
- 5) Determine your data connection requirements and either provide your own inserts and connectors or include from those shown here. Use the inserts that begin with INSERT-MA....  
For example INSERT-MA-S68-RJ45-AL is a Category 6 RJ45 jack.

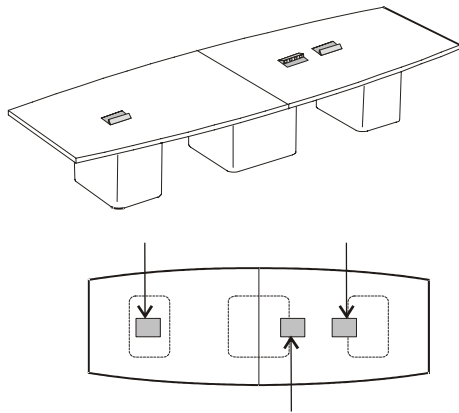

EXAMPLE: adding three MINI-ACT-3-4-JPLUG to TB58168-RC table.

One MINI-ACT power - data units is specified directly above an end base. Two are between the center and other end base. Optional Base Hinged Doors may be added to any or all of the table bases.

For the J-PLUG models, the units must be within 10' of the floor monument. For the hardwired STARTER and ADDER units, the floor monument / power connection may be located at any of the table bases.

The V-BAY wiremanager is a good option for running the wiring between power - data units and manages the wiring when the power - data units are not directly over a table base. Each V-Bay section connects two of the table bases. Please specify the floor monument locations.

Typical section view of table top, table base and V-BAY wiremanager.

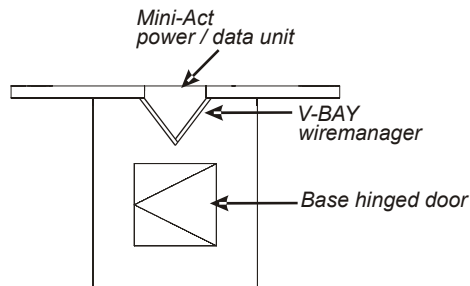

## MINI-ACT Tables

### MINI-ACT Power - Data units, V-BAY wiremanager, Data Connectors

Description	Model Number	List
<b>MINI-ACT 3-4 double doors</b>	MINI-ACT-3-4-120-JPLUG 120" plugin cord	494
	MINI-ACT-3-4-72-STARTER 72" power entry cable, hardwired	530
	MINI-ACT-3-4-48-ADDER up to 48" between units, hardwired	386
	MINI-ACT-3-4-72-ADDER up to 72" between units, hardwired	429
	MINI-ACT-3-4-120-ADDER up to 120" between units, hardwired	479
May be used either open (outlets and data ports visible) or closed (outlets and data ports not visible). Available in black or silver.		
<b>MINI-ACT 2-2 single door</b> 8.25" x 4.5"	MINI-ACT-2-2-120-JPLUG 120" plugin cord	396
	MINI-ACT-2-2-72-STARTER 72" power entry cable, hardwired	434
	MINI-ACT-2-2-48-ADDER up to 48" between units, hardwired	292
	MINI-ACT-2-2-72-ADDER up to 72" between units, hardwired	324
	MINI-ACT-2-2-120-ADDER up to 120" between units, hardwired	383
Must be used open (outlets and data ports visible). Available in black or silver.		
The STARTER and ADDER MINI-ACT-3-4... models and MINI-ACT-2-2... models may NOT be combined on the same circuit.		
<b>fit over bases</b>	When a MINI-ACT unit is located directly over a table base, any cutouts in the table base required for the unit to open and close are automatically included.	
<b>Orientation</b>	When placed in a table, orientation is to the <b>SIDE</b> of the table.	
<b>Location</b>	MINI-ACT Power - Data units use the same locations as grommets, over the bases at the end of the table use E1, E2, over the bases in between the end bases or for the center of the table use C1, C2 (288" only)	
<b>V-BAY sections</b>	V-BAY-SECTION-1 cutouts in the table bases are included	301
Bases use V-BAY-SECTIONS		
	2 - 1 42" or 48" deep to 120" long; 58" deep to 150" long; Egg	
	3 - 2 48" deep over 120" long; 58" deep from 168" to 240" long	
	4 - 3 58" deep at 288" long	
<b>Base Hinged Doors</b>	BHD-RC Add base hinged door to Radius Cube base	145
	BHD-HC Add base hinged door to the flat side of half cyl	145
	BHD-RHC Add base hinged door to the flat side of RHC	145
	BHD-CYL Add base hinged door to a fullcylinder	308
<b>MINI-ACT INSERTS</b>	INSERT-MA-CAT6-RJ45-S68	28
	INSERT-MA-CAT5-RJ45-S58	17
	INSERT-MA-PHONE-RJ25-S6U-BK	14
	INSERT-MA-AUDIO-RCA	15
	INSERT-MA-VIDEO-1SVHS	18
<b>TOP ACCENT</b>	TOP-ACCENT-WP-SECTION any standard WoodPlus or WoodPlus XTRA	711
	TOP-ACCENT-LAM-SECTION any standard HPL pattern	711
	TOP-ACCENT-METAL-SECTION uses the metal sheet with phenolic backer	833
	One Top Accent when 42" or 48" deep to 120" long; 58" deep to 150" long; Egg	
	Two Top Accents when 48" deep over 120" long; 58" deep from 168" to 240" long	
	Three Top Accents when 58" deep at 288" long	
Accent 'fits between' two MINI-ACT power - data units on the table top. It is also available as option without power-data units on the table top.		
<b>METRO ACCENT</b>	METRO-ACCENT-WP-EA any standard WoodPlus or WoodPlus XTRA	268
	METRO-ACCENT-HPL-EA any standard HPL pattern	268
	METRO-ACCENT-METAL-EA uses the solid metal sheet material	390
Accent is inset between the METRO base ends. Price per table base.		

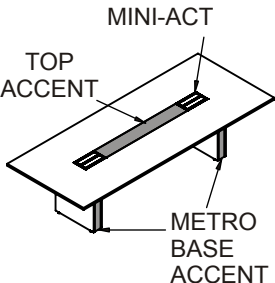
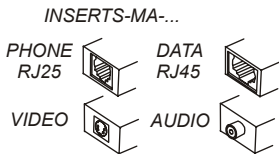
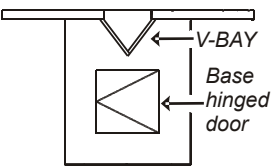
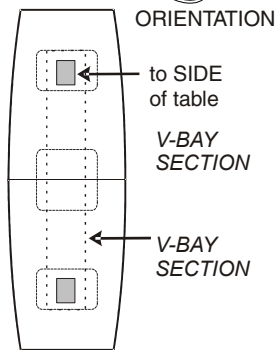
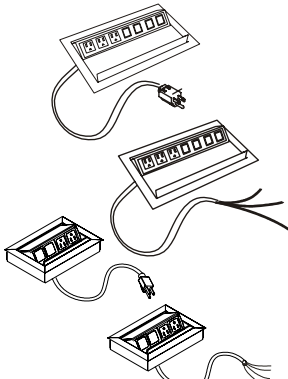

## MINI-ACT Tables

### Conference tables: typical distance between bases

You may use the dimensions, typically from the center of one table base to the center of the adjacent one, to gauge the length of the plugin power cord or the length of the hardwired adder connection when ordering the MINI-ACT units.

**TB48120-RC**

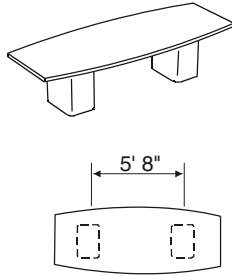

**TDE58120-RC**

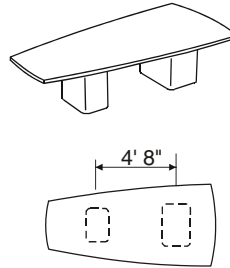

**TR48144-HC**

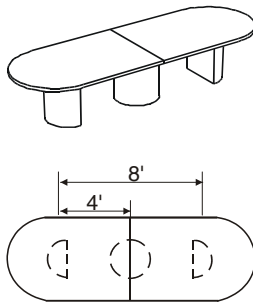

**TT58168-RC**

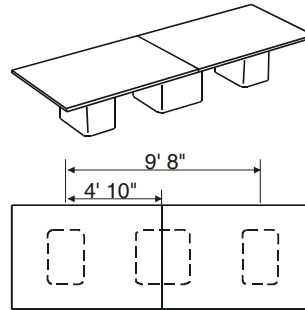

**TR58168-CYL**

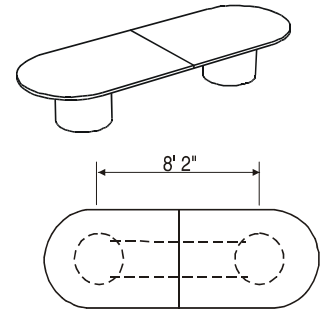

**TB58192-RC**

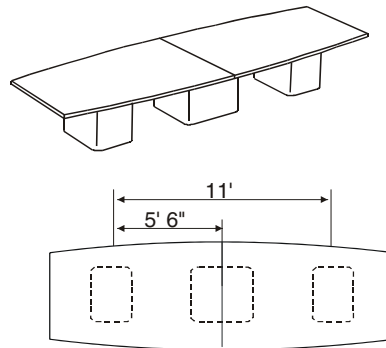

**TR58192-CYL**

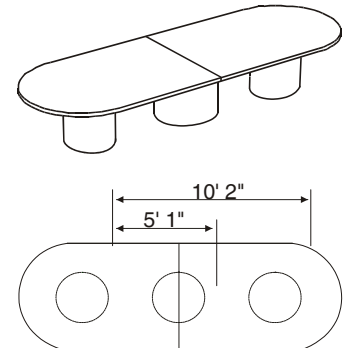

**Figure , "Boat TB shaped top table base information," on**

**Overview - Conference Tables**

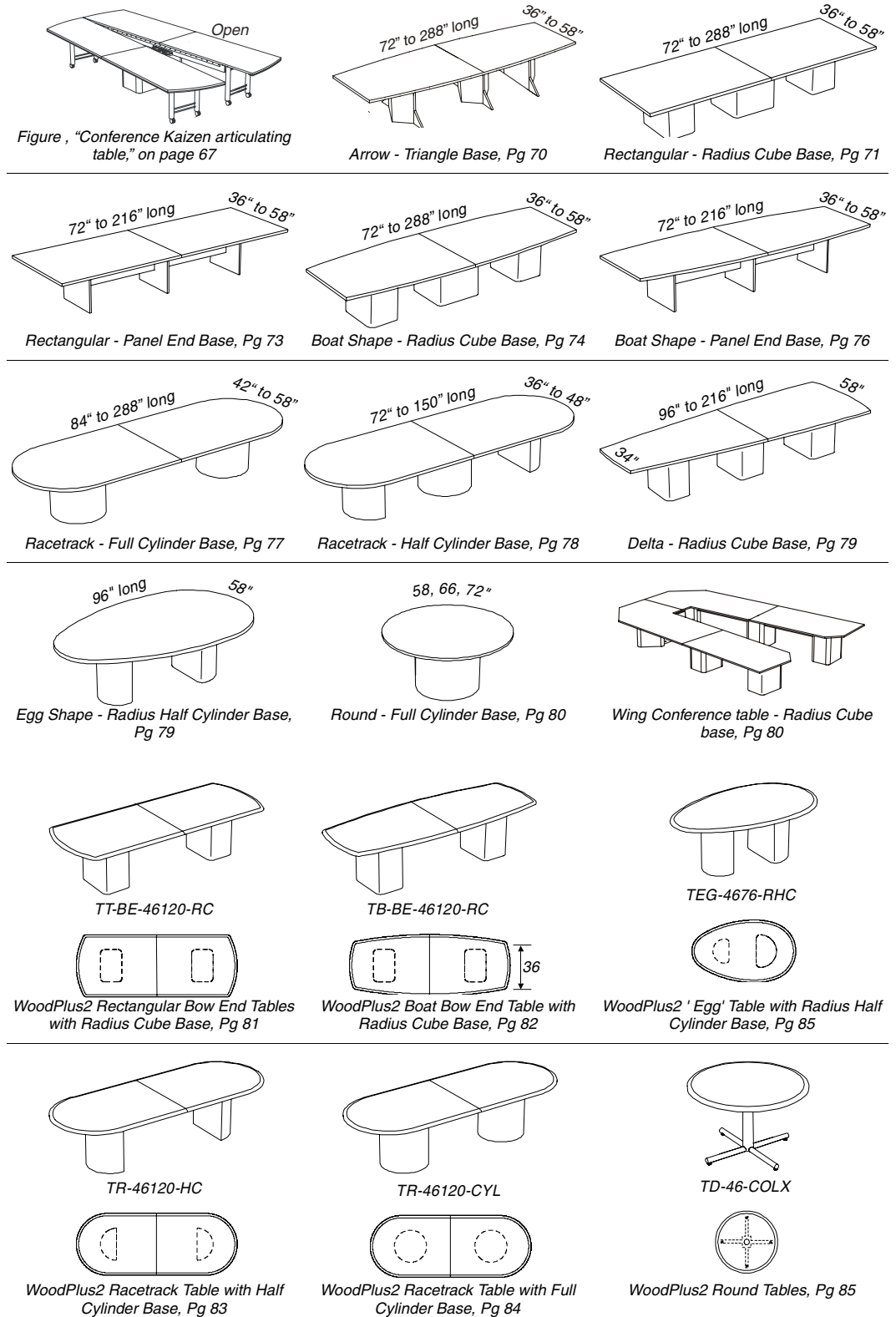

# Conference Tables

## Boat TB shaped top table base information

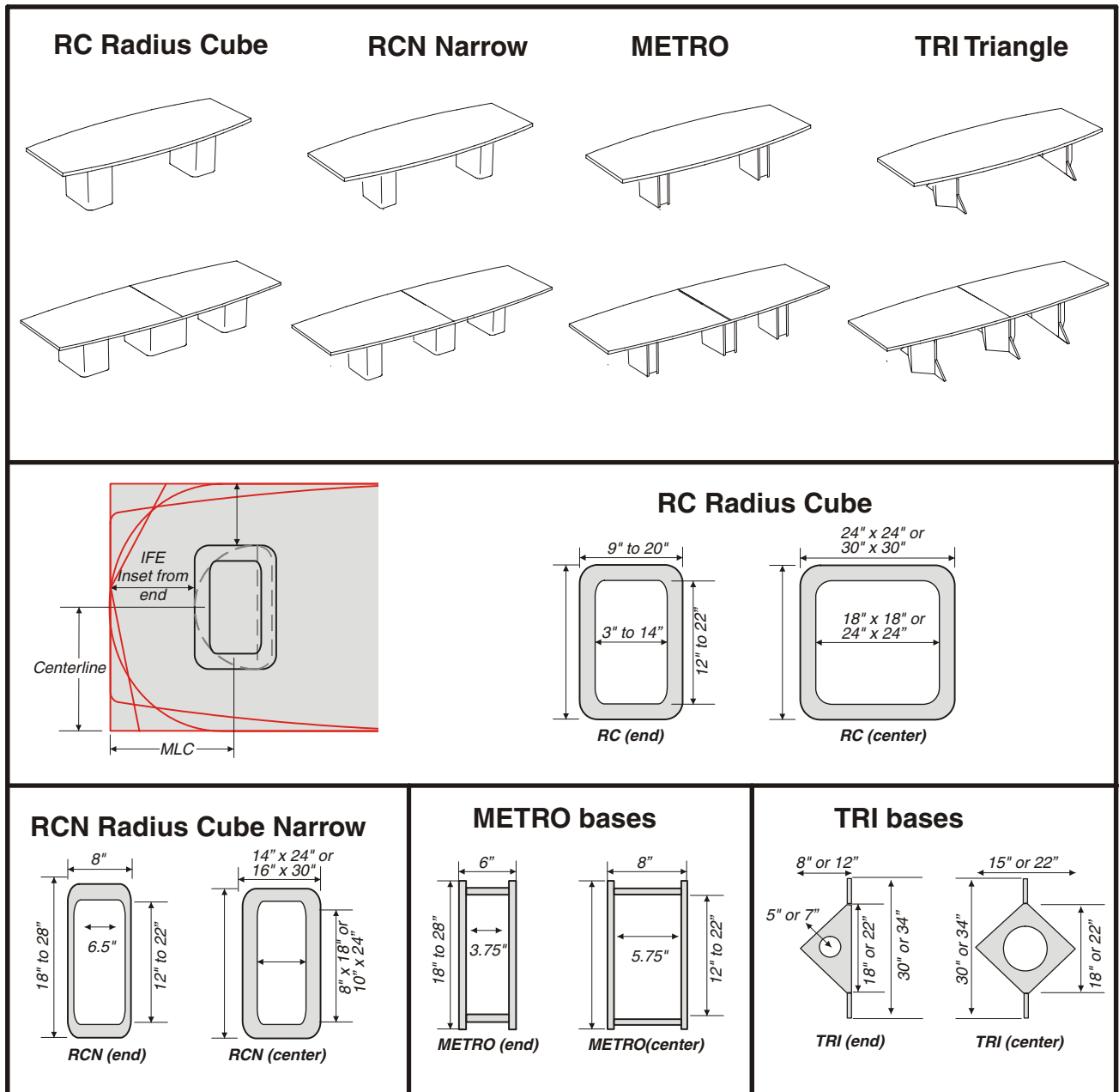

## Conference Tables

### Boat TB shaped top table base information

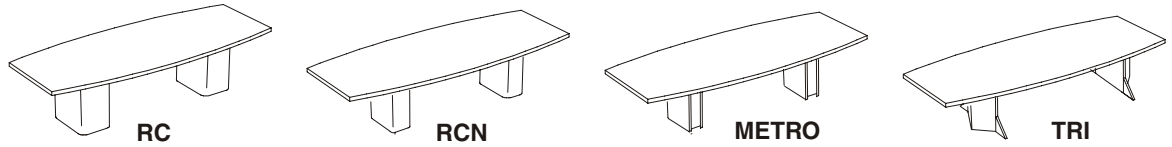

Wide	Long	(A)	RC base (C)				RCN base (C)				METRO base (C)				TRI base (C)			
		MLC	Qty	End	Center	IFE	Qty	End	Center	IFE	Qty	End	Center	IFE	Qty	End	Center	IFE
36	72		2	9x18		14	2	8x18		15	2	6x18		16	2	8x30		14
42	72	20	2	9x18		14	2	8x18		15	2	6x18		16	2	8x30		14
42	84	24	2	9x18		18	2	8x18		20	2	6x18		18	2	8x30		18
42	96	24	2	12x18		18	2	8x18		20	2	6x18		18	2	8x30		20
42	120	24	2	12x18		18	2	8x18		20	2	6x18		18	2	8x30		20
42	144	24	3	12x16	18x18	18	3	8x16	12x18	20	3	6x16	8x18	18	3	8x30	15x30	20
42	150	24	3	12x16	18x18	18	3	8x16	12x18	20	3	6x16	8x18	18	3	8x30	15x30	20
42	168	24	3	12x16	18x18	18	3	8x16	12x18	20	3	6x16	8x18	18	3	8x30	15x30	20
46	72	25	2	14x20		18	2	8x20		21	2	6x20		22	2	8x30		21
46	84	25	2	14x20		18	2	8x20		21	2	6x20		22	2	8x30		21
46	96	25	2	14x20		18	2	8x20		21	2	6x20		22	2	8x30		21
46	120	25	2	14x20		18	2	8x20		21	2	6x20		22	2	8x30		21
46	144	25	3	14x18	20x20	18	3	8x18	14x20	21	3	6x20	8x20	22	3	8x30	15x30	21
46	150	25	3	14x18	20x20	18	3	8x18	14x20	21	3	6x20	8x20	22	3	8x30	15x30	21
46	168	25	3	14x18	20x20	18	3	8x18	14x20	21	3	6x20	8x20	22	3	8x30	15x30	21
48	72	20	2	12x22		14	2	8x22		15	2	6x22		16	2	8x30		18
48	84	24	2	12x22		18	2	8x22		20	2	6x22		18	2	8x30		18
48	96	24	2	12x22		18	2	8x22		20	2	6x22		18	2	8x30		18
48	120	24	2	16x22		18	2	8x22		20	2	6x22		18	2	8x30		18
48	144	24	3	14x20	24x24	18	3	8x20	14x24	20	3	6x20	8x24	18	3	8x30	15x30	18
48	150	24	3	14x20	24x24	18	3	8x20	14x24	20	3	6x20	8x24	18	3	8x30	15x30	18
48	168	24	3	14x20	24x24	18	3	8x20	14x24	20	3	6x20	8x24	18	3	8x30	15x30	18
58	120	26	2	20x28		20	2	8x28		22	2	6x28		20	2	12x34		24
58	144	26	2	20x28		20	3	8x24	16x30	22	3	6x24	8x30	20	2	12x34		24
58	150	26	2	20x28		20	3	8x24	16x30	22	3	6x24	8x30	20	2	12x34		24
58	168	26	3	16x24	30x30	20	3	8x24	16x30	22	3	6x24	8x30	20	3	12x34	22x34	24
58	180	26	3	16x24	30x30	20	3	8x24	16x30	22	3	6x24	8x30	20	3	12x34	22x34	24
58	192	26	3	16x24	30x30	20	3	8x24	16x30	22	3	6x24	8x30	20	3	12x34	22x34	24
58	216	28	3	16x24	30x30	20	3	8x24	16x30	24	3	6x24	8x30	24	3	12x34	22x34	24
58	240	28	3	16x24	30x30	20	3	8x24	16x30	24	3	6x24	8x30	24	3	12x34	22x34	24
58	288	28(B)	4	16x24	30x30	20	4	8x24	16x30	24	4	6x24	8x30	24	4	12x34	22x34	24

(A) - MLC - center of the monument locaton is this distance from the end of the table

(B) - MLC - center base monument locaton is 104" or 8' 8" from the end of the table

(C) - IFE - Inset From End - how far is the base from the end of the table

Monument cutout for

RC Radius Cube and RCN Radius Cube Narrow bases is 6" less in each dimension. Exception for RC or RCN bases 8" or 9" long.

METRO bases at 6" wide is 3.75", at 8" wide is 5.75". For length, deduct 4" from the length of the base.

TRI end bases at 28 long, opening is 5" diameter, TRI center bases at 28" long, opening is 7".

TRI end bases at 34 long, opening is 7" diameter, TRI center bases at 34" long, opening is 7".

# Conference Tables

## Rectangle TT and Arrow TAR table base information

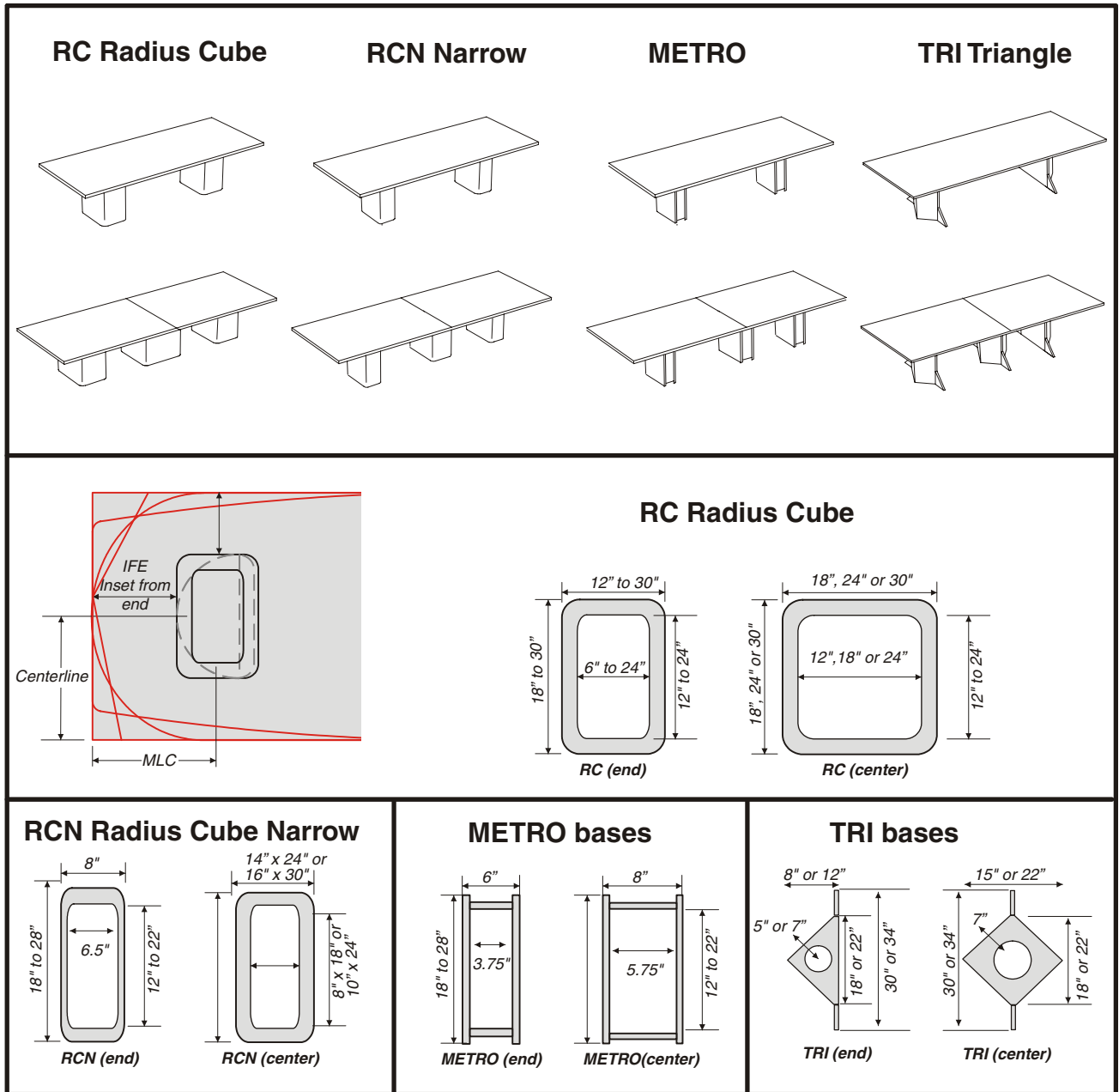



## Conference Tables

### Rectangle TT and Arrow TAR table base information

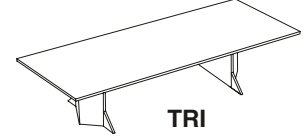
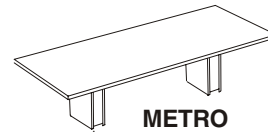
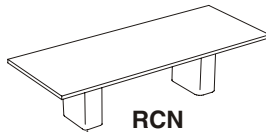
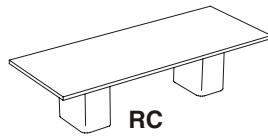

Wide	Long	(A) MLC	RC base (C)				RCN base (C)				METRO base (C)				TRI base (C)			
			Qty	End	Center	IFE	Qty	End	Center	IFE	Qty	End	Center	IFE	Qty	End	Center	IFE
36	72	24	2	12x18		18	2	8x18		20	2	6x18		21	2	8x30		18
42	72	24	2	12x18		18	2	8x18		20	2	6x18		21	2	8x30		18
42	84	24	2	12x18		18	2	8x18		20	2	6x18		21	2	8x30		18
42	96	24	2	12x18		18	2	8x18		20	2	6x18		21	2	8x30		18
42	120	24	2	12x18		18	2	8x18		20	2	6x18		21	2	8x30		18
42	144	24	3	12x18	18x18	18	3	8x18	12x18	20	3	6x18	8x18	21	3	8x30	15x30	18
42	150	24	3	12x18	18x18	18	3	8x18	12x18	20	3	6x18	8x18	21	3	8x30	15x30	18
42	168	24	3	12x18	18x18	18	3	8x18	12x18	20	3	6x18	8x18	21	3	8x30	15x30	18
46	72	25	2	14x20		18	2	8x20		21	2	6x20		22	2	8x30		21
46	84	25	2	14x20		18	2	8x20		21	2	6x20		22	2	8x30		21
46	96	25	2	14x20		18	2	8x20		21	2	6x20		22	2	8x30		21
46	120	25	2	14x20		18	2	8x20		21	2	6x20		22	2	8x30		21
46	144	25	3	14x20	20x20	18	3	8x20	14x20	21	3	6x20	8x20	22	3	8x30	15x30	21
46	150	25	3	14x20	20x20	18	3	8x20	14x20	21	3	6x20	8x20	22	3	8x30	15x30	21
46	168	25	3	14x20	20x20	18	3	8x20	14x20	21	3	6x20	8x20	22	3	8x30	15x30	21
48	72	24	2	16x24		18	2	8x24		22	2	6x24		23	2	8x30		18
48	84	24	2	16x24		18	2	8x24		22	2	6x24		23	2	8x30		18
48	96	24	2	16x24		18	2	8x24		22	2	6x24		23	2	8x30		18
48	120	24	2	16x24		18	2	8x24		22	2	6x24		23	2	8x30		18
48	144	24	3	16x24	24x24	18	3	8x24	14x24	22	3	6x24	8x24	23	3	8x30	15x30	18
48	150	24	3	16x24	24x24	18	3	8x24	14x24	22	3	6x24	8x24	23	3	8x30	15x30	18
48	168	24	3	16x24	24x24	18	3	8x24	14x24	22	3	6x24	8x24	23	3	8x30	15x30	18
58	120	30	2	20x30		20	2	8x30		26	2	6x30		26	2	12x34		24
58	144	30	2	20x30		20	2	8x30		26	2	6x30		26	2	12x34		24
58	150	30	2	20x30		20	2	8x30		26	2	6x30		26	2	12x34		24
58	168	30	3	20x30	30x30	20	3	8x30	16x30	26	3	6x30	8x30	26	3	12x34	22x34	24
58	180	30	3	20x30	30x30	20	3	8x30	16x30	26	3	6x30	8x30	26	3	12x34	22x34	24
58	192	30	3	20x30	30x30	20	3	8x30	16x30	26	3	6x30	8x30	26	3	12x34	22x34	24
58	216	30	3	20x30	30x30	20	3	8x30	16x30	26	3	6x30	8x30	26	3	12x34	22x34	24
58	240	30	3	20x30	30x30	20	3	8x30	16x30	26	3	6x30	8x30	26	3	12x34	22x34	24
58	288	30(B)	4	20x30	30x30	20	4	8x30	16x30	26	4	6x30	8x30	26	4	12x34	22x34	24

(A) - MLC - center of the monument locaton is this distance from the end of the table

(B) - MLC - center base monument locaton is 104" or 8' 8" from the end of the table

(C) - IFE - Inset From End - how far is the base from the end of the table

Monument cutout for

RC Radius Cube and RCN Radius Cube Narrow bases is 6" less in each dimension. Exception for RC or RCN bases 8" or 9" long.

METRO bases at 6" wide is 3.75", at 8" wide is 5.75". For length, deduct 4" from the length of the base.

TRI end bases at 28 long, opening is 5" diameter, TRI center bases at 28" long, opening is 7".

TRI end bases at 34 long, opening is 7" diameter, TRI center bases at 34" long, opening is 7".

# Conference Tables

## Racetrack TR table base information

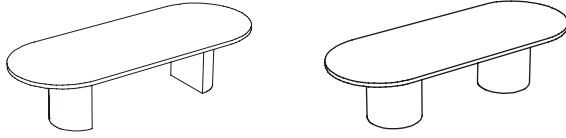

Wide	Long	(A) MLC	HC base (C)			CYL base (C)		
			Qty	End	Center	IFE	Qty	Diameter
36	72	24	2	10x18		18		
42	72	24	2	10x18		18	2	18x18
42	84	24	2	10x18		18	2	18x18
42	96	24	2	10x18		18	2	18x18
42	120	24	2	10x18		18	2	18x18
42	144	24	3	10x18	18x18	18	2	18x18
42	150	24	3	10x18	18x18	18	2	18x18
42	168	24	3	10x18	18x18	18	3	18x18
46	72	25	2	11x20		18		
46	84	25	2	11x20		18		
46	96	25	2	11x20		18	2	20x20
46	120	25	2	11x20		18	2	20x20
46	144	25	3	11x20	20x20	18	2	20x20
46	150	25	3	11x20	20x20	18	2	20x20
46	168	25	3	11x20	20x20	18	3	20x20
48	72	24	2	13x24		18		
48	84	24	2	13x24		18		
48	96	24	2	13x24		18	2	24x24
48	120	24	2	13x24		18	2	24x24
48	144	24	3	13x24	24x24	18	2	24x24
48	150	24	3	13x24	24x24	18	2	24x24
48	168	24	3	13x24	24x24	18	3	24x24
58	120	30	2	16x30		20	2	30x30
58	144	30	2	16x30		20	2	30x30
58	150	30	2	16x30		20	2	30x30
58	168	30	3	16x30	30x30	20	2	30x30
58	180	30	3	16x30	30x30	20	3	30x30
58	192	30	3	16x30	30x30	20	3	30x30
58	216	30	3	16x30	30x30	20	3	30x30
58	240	30	3	16x30	30x30	20	3	30x30
58	288	30(B)	4	16x30	30x30	20	4	30x30

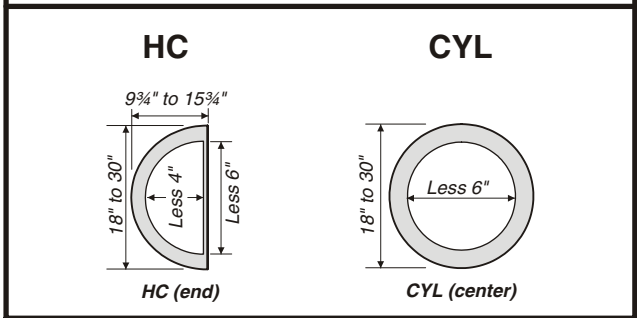
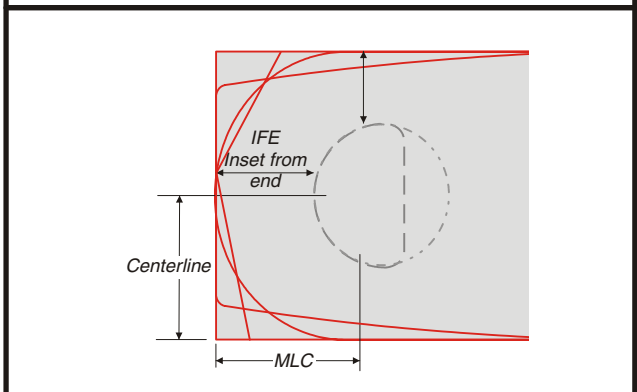
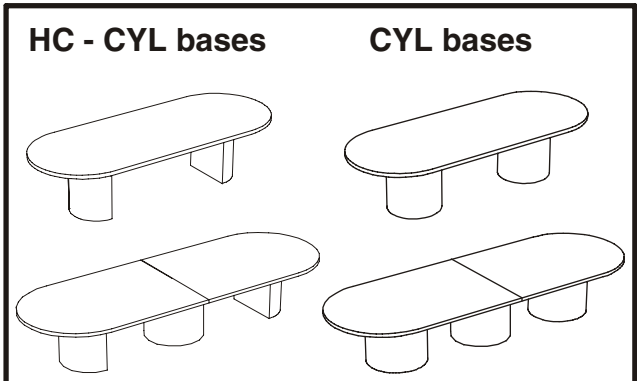

- (A) - MLC - center of the monument location is this distance from the end of the table
- (B) - MLC - center base monument location is 104" or 8' 8" from the end of the table
- (C) - IFE - Inset From End - how far is the base from the end of the table

**Monument cutout for**

HC Half Cylinder bases are 4" less in length and 6" less in width.

CYL Full Cylinder bases are 6" less in each dimension

# Conference Tables

## Delta TDE table base information

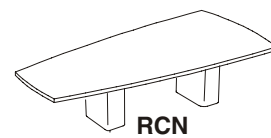
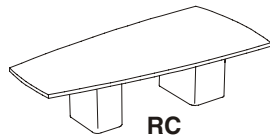
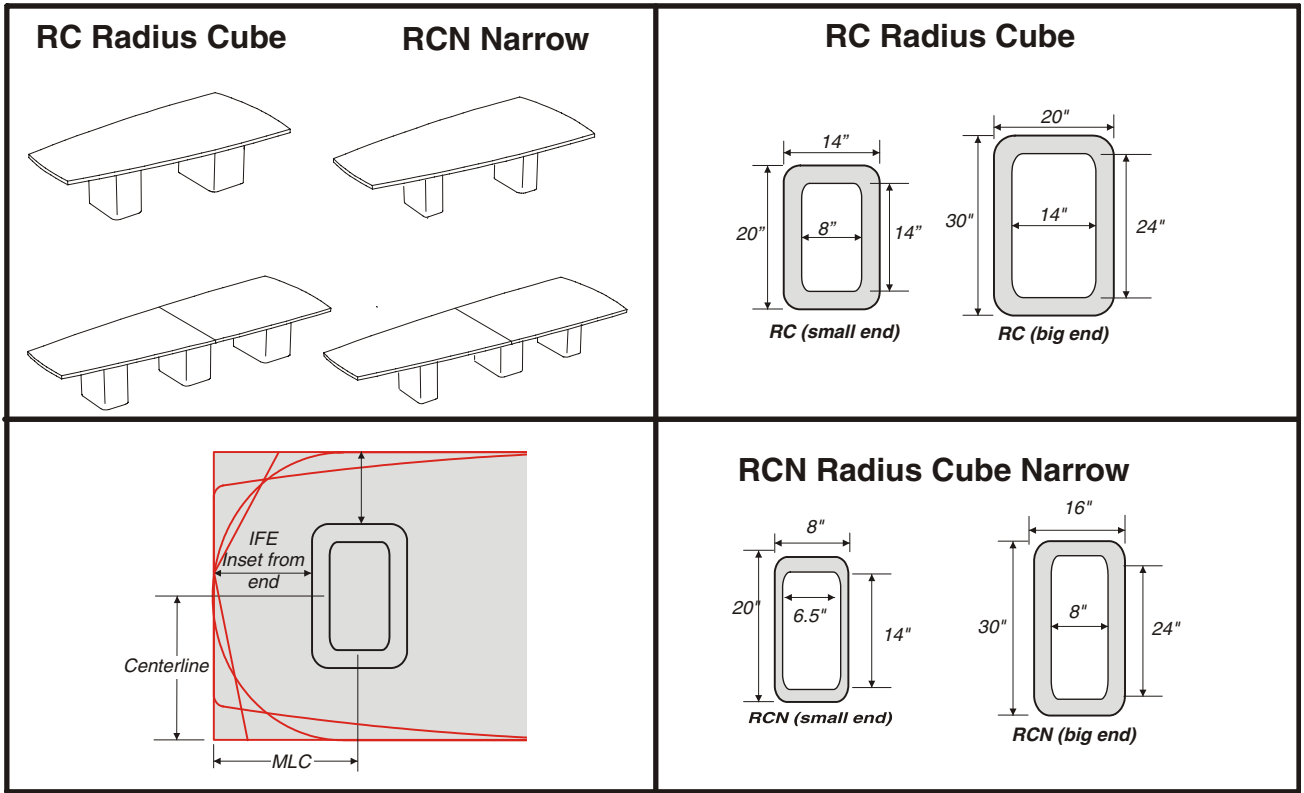

Wide	Long	MLC (A)		Qty	RC base (C)				Center	RCN base (C)					
		Small	Big		Small	IFE	Big	IFE		Qty	Small	IFE	Big	IFE	Center
58	96	35	28	2	14x20	28	20x30	18		2	8x20	31	16x30	20	
58	120	35	28	2	14x20	28	20x30	18		2	8x20	31	16x30	20	
58	144	35	28	2	14x20	28	20x30	18		2	8x20	31	16x30	20	
58	150	35	28	2	14x20	28	20x30	18		2	8x20	31	16x30	20	
58	168	35	28	3	14x20	28	20x30	18	30x30	3	8x20	31	16x30	20	16x30
58	180	35	28	3	14x20	28	20x30	18	30x30	3	8x20	31	16x30	20	16x30
58	192	35	28	3	14x20	28	20x30	18	30x30	3	8x20	31	16x30	20	16x30
58	216	35	28	3	14x20	28	20x30	18	30x30	3	8x20	31	16x30	20	16x30

(A) - MLC - center of the monument location from the end of the table - SMALL is the small end of the table, BIG is the big end of the table.

(C) - IFE - Inset From End - how far is the base from the end of the table

**Monument cutout for**

RC Radius Cube and RCN Radius Cube Narrow bases is 6" less in each dimension. Exception for RC or RCN bases 8" or 9" long.

## Conference Tables

### Round TD table base information

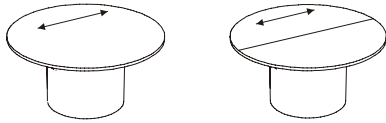

Diameter	(A)		CYL base		(C)
	MLC	Qty	Diameter	IFE	
58	29	1	30	14	
66	33	1	36	15	
72	36	1	36	18	

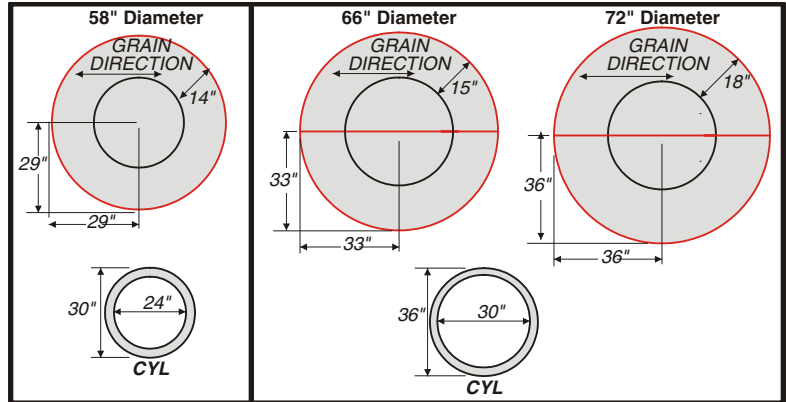

(A) - MLC - center of the monument location is this distance from the edge of the table

(C) - IFE - Inset From End - how far is the base from the edge of the table

Monument cutout for

CYL Full Cylinder bases are 6" less in each dimension

### Egg shaped TEG table base information

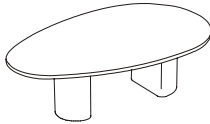

	(A)	RHC base			(C)	
		MLC	Qty	Small		Big
46	76		2	12x18	15x24	
58	96		2	12x16	17x28	

(A) - MLC - center of monument location shown in drawing to the right.

(C) - IFE - Inset From End - shown in drawing to the right

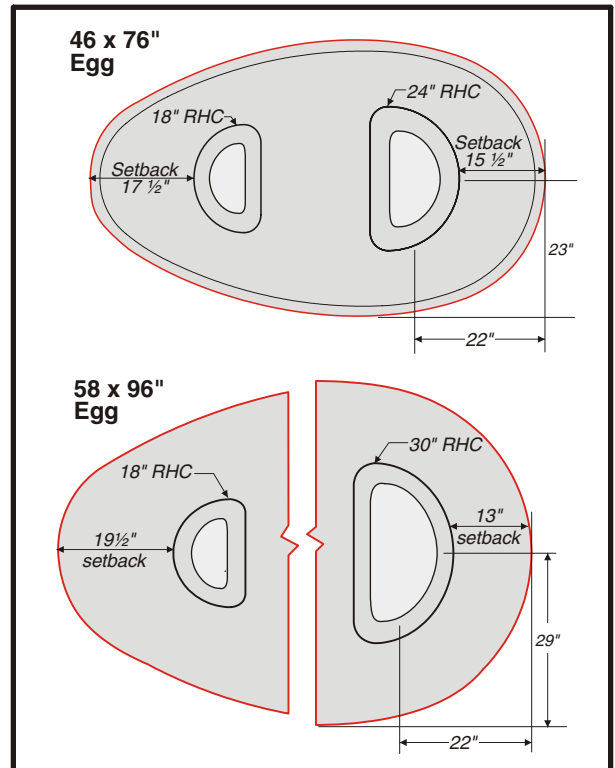

Monument cutout for

RHC Radius Half Cylinder bases are 6" less in each dimension

# KAIZEN Conference Articulating Tables

## Conference Kaizen articulating table

Description	Model Number	Wgt	List Prices				
			WoodPlus	Standard	Detailed	2000	3000
<b>KAIZEN table</b>	TKZ-72144--RC	990	<b>28569</b>	28881	29348	30669	31577
	TKZ-72168-RC	1080	<b>29844</b>	30311	30734	32150	33122
	TKZ-72192-RC	1170	<b>30047</b>	30514	31160	32517	33663

KAIZEN table opens at either or both ends

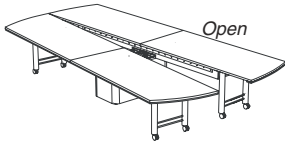

Open

Closed

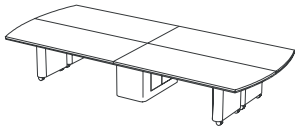

Top: 2 sides. Bases: center of table includes BHD Base Hinged Door. Includes the MINI-COVERS at the top of the HLEGS.

H-Leg standard finish is Black or Silver. Black will be provided unless otherwise specified.

Description	Model Number	Wgt	List Prices				
			WoodPlus	Standard	Detailed	2000	3000
<b>H-Leg Covers</b>	TKZ-RC-COVERS	32	<b>1264</b>	1264	1264	1264	1264

Four RC covers included, one for each HLEG on the table. RC covers match the center base finish color.

Table shown with the four RC-COVERS in place

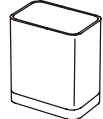

Center Base Silver Accent

Description	Model Number	Wgt	List Prices				
			WoodPlus	Standard	Detailed	2000	3000
<b>Silver Accent Center Base</b>	BASE-SILVER-ACCENT-KAIZEN	0	<b>328</b>	328	328	328	328

Silver Accent strip for center base - 3" high.

Seating capacity and room size	for the 144" (12') long table	seats 10 to 12	minimum room size 14' 6" by 20'
	for the 168" (14') long table	seats 14 to 16	minimum room size 16' 6" by 22'
	for the 192" (16') long table	seats 16 to 18	minimum room size 18' 6" by 24'

144, 168, 192  
168" long table shown above

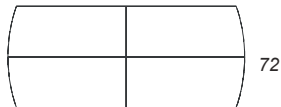

Model Numbers:  
Shape 72 long RC  
e.g. TKZ-72 168-RC

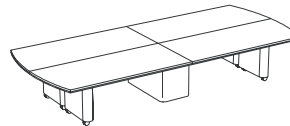

Table is closed

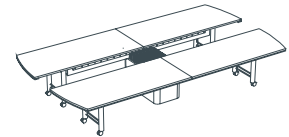

Table open at both ends

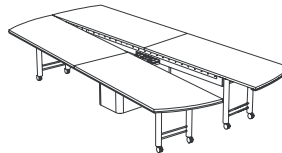

Table open end is to the right

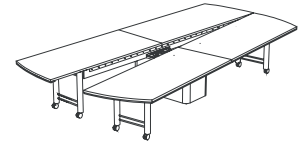

Table open end is to the left

**IMPORTANT: Tables are standard with wood grain running length of table.**

### Finish Colors

Specify table Finish Colors.

For non-standard top laminates, please contact Customer Service for availability and upcharge.  
Custom color wood edge . . . . .

### Notes:

- Tables are shipped RTA (ready to assemble)

### Options

Options are built-in at factory

INLAY -available ONLY with Detailed or larger edge

INP Black 3mm (1/8") Inlay:

INB Brushed Brass 3mm Inlay or

INC Satin Chrome 3mm Inlay:

See the end of this section for pricing on all options and accessories.



# Conference Tables

## Arrow - Pyramid Base

Description	Model Number	Wgt	List Prices				
			WoodPlus WPE	STD	Wood Edges		3000
					DET	2000	
<b>48" Wide</b>	TAR4884-PYR	324	<b>5974</b>	6174	6642	7523	7968
	TAR4896-PYR	344	<b>6232</b>	6432	6900	7781	8226
	TAR48120-PYR	424	<b>6847</b>	7081	7515	8778	9449
Top: 1 piece. Base: 2 PYR. 120" long may be specified as 2 piece top.							
<b>48" Wide</b>	TAR48144-PYR	516	<b>8425</b>	8721	9204	10525	11433
	TAR48150-PYR	526	<b>9585</b>	9881	10364	11685	12593
	TAR48168-PYR	556	<b>9705</b>	10063	10595	12011	12983
Top: 2 piece. Base: 3 PYR.							
<b>58" Wide</b>	TAR58120-PYR	466	<b>6869</b>	7103	7537	8800	9471
	Top: 1 piece. Base: 2 PYR. 120" long may be specified as 2 piece top.						
<b>58" Wide</b>	TAR58144-PYR	554	<b>7507</b>	7803	8286	9607	10515
	TAR58150-PYR	566	<b>8774</b>	9070	9553	10874	11782
Top: 2 piece. Base: 2 PYR.							
<b>58" Wide</b>	TAR58168-PYR	674	<b>9932</b>	10290	10822	12238	13210
	TAR58180-PYR	699	<b>10029</b>	10387	10919	12335	13307
	TAR58192-PYR	723	<b>10221</b>	10683	11223	12691	13837
	TAR58216-PYR	851	<b>11255</b>	11717	12257	13725	14871
	TAR58240-PYR	899	<b>11544</b>	12011	12657	14457	15818
Top: 2 piece. Base: 3 PYR.							
<b>58" Wide</b>	TAR58288-PYR	1148	<b>15692</b>	16088	17250	19109	20813
	Top: 3 piece. Base: 4 PYR.						

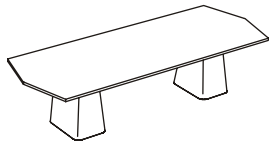

TAR48120-PYR

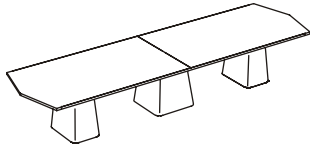

TAR48168-PYR

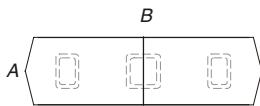

Model Numbers:  
Shape A B Base  
e.g. TAR 48 168 PYR

**IMPORTANT:** Tables are standard with wood grain running length of table.

**Notes:**

- Conference tables are shipped RTA (ready to assemble)

**Options**

Options are built-in at factory

Grommets ..... see page at end of this section

**Options**

Options are built-in at factory

INLAY -available ONLY with Detailed or larger edge

- INP Black 3mm (1/8") Inlay
- INB Brushed Brass 3mm Inlay or
- INC Satin Chrome 3mm Inlay

Rectangle top with Bow End or C3R options uses the 'shape inlay' price.

When a Rectangular table top is ordered with 2000 Series edge and an inlay, please add the optional Bow End (BE) or the Corners with 3" Radius (C3R).

# Conference Tables

## Arrow - Triangle Base

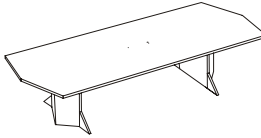
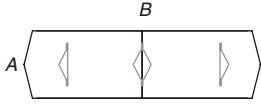
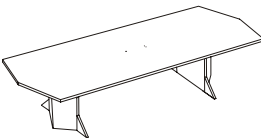
Description	Model Number	Wgt	List Prices				
			WoodPlus WPE	STD	Wood Edges DET		2000
 <p><b>36" wide,</b></p>	TAR3672-TRI	246	<b>2671</b>	2866	3239	3915	4437
	Top: 1 piece; Base: 2 TRI						
	TAR4272-TRI	261	<b>2864</b>	3059	3432	4108	4630
	TAR4284-TRI	279	<b>3010</b>	2840	3678	4559	5004
	TAR4296-TRI	296	<b>3157</b>	3357	3825	4706	5151
Top: 1 piece; Base: 2 TRI							
 <p><b>48" wide</b></p> <p>Model Numbers: Shape A B Base e.g. TAR 48 168 TRI</p>	TAR4872-TRI	304	<b>2912</b>	3107	3480	4156	4678
	Top: 1 piece; Base: 2 TRI						
	TAR4884-TRI	324	<b>3059</b>	3259	3727	4608	5053
	TAR4896-TRI	344	<b>3205</b>	3024	3873	4754	5199
	TAR48120-TRI	424	<b>3500</b>	3734	4168	5431	6102
	Top: 1 piece; Base: 2 TRI. 120" long may be specified as 2 piece top.						
	TAR48144-TRI	516	<b>3866</b>	4162	4645	5966	6874
	TAR48150-TRI	526	<b>4004</b>	4300	4783	6104	7012
	TAR48168-TRI	556	<b>4086</b>	4444	4976	6392	7364
	Top: 2 piece; Base: 3 TRI.						
 <p><b>4976</b></p>	TAR58120-TRI	466	<b>4740</b>	4974	5408	6671	7342
	Top: 1 piece; Base: 2 TRI. 120" long may be specified as 2 piece top.						
	TAR58144-TRI	554	<b>5076</b>	5372	5855	7176	8084
	TAR58150-TRI	566	<b>5359</b>	5655	6138	7459	8367
	Top: 2 piece; Base: 2 TRI.						
	TAR58168-TRI	674	<b>5359</b>	5717	6249	7665	8637
	TAR58180-TRI	699	<b>6790</b>	7148	7680	9096	10068
	TAR58192-TRI	723	<b>7019</b>	7481	8021	9489	10635
	TAR58216-TRI	851	<b>7250</b>	7712	8252	9720	10866
	TAR58240-TRI	899	<b>7480</b>	7947	8593	10393	11754
Top: 2 piece; Base: 3 TRI							
TAR58288-TRI	1148	<b>9458</b>	9854	11016	12875	14579	
Top: 3 piece; Base: 4 TRI							

**IMPORTANT: Tables are standard with wood grain running length of table.**

### Edge Options Information

Tables are available with the following edge options:

- WoodPlus 3 mm PVC edge
- Standard 3 mm Wood Edge
- Detailed 3/8" Wood Edge
- 2000 Series hardwood edges
- 3000 Series hardwood edges

Edge Options Information	WoodPlus 3 mm PVC	Standard Wood	Detailed Wood	2000 Wood	3000 Wood	
Equations	WPES	Equations SWES	RE	2000	1000	
Modular 8	WPER	Modular 8 SWER	RA	2001	1100	
WPMS	WPEN	SWMS	SWEN	BE	2002	1200
WPMN		SWMN	TR	2003	2200	
WPMR		SWMR	CL	2004	2100	

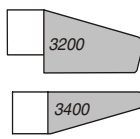



## Conference Tables

### Rectangular - Radius Cube Base

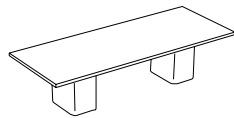

TT48120-RC

Description	Model Number	Wgt	List Prices				
			WoodPlus	Standard	Wood Edges		
					Detailed	2000	3000
<b>36" wide, 18" wide base</b>	TT3672-RC	246	<b>2849</b>	3013	3181	3871	4392
	Top: 1 piece; Base: 2 RC						
	TT4272-RC	261	<b>3050</b>	3214	3382	4072	4593
	TT4284-RC	279	<b>3474</b>	3674	3939	4800	5245
	TT4296-RC	296	<b>3541</b>	3741	4006	4867	5312
	Top: 1 piece; Base: 2 RC						
<b>48" wide 24" wide base</b>	TT4872-RC	304	<b>3050</b>	3214	3382	4072	4593
	Top: 1 piece; Base: 2 RC						
	TT4884-RC	324	<b>3474</b>	3674	3939	4800	5245
	TT4896-RC	344	<b>3541</b>	3741	4006	4867	5312
	TT48120-RC	424	<b>4005</b>	4239	4562	5673	6385
	Top: 1 piece; Base: 2 RC. 120" long may be specified as 2 piece top.						
	TT48144-RC	516	<b>4590</b>	4894	5258	6343	7264
	TT48150-RC	526	<b>5512</b>	5816	6180	7265	8186
	TT48168-RC	556	<b>5520</b>	5876	6299	7312	8464
	Top: 2 piece; Base: 3 RC.						
<b>58" wide 30" wide base</b>	TT58120-RC	466	<b>4122</b>	4356	4679	5790	6502
	Top: 1 piece; Base: 2 RC. 120" long may be specified as 2 piece top.						
	TT58144-RC	554	<b>4611</b>	4915	5279	6364	7285
	TT58150-RC	566	<b>5628</b>	5932	6296	7381	8302
	Top: 2 piece; Base: 2 RC.						
	TT58168-RC	674	<b>5960</b>	6316	6739	7752	8904
	TT58180-RC	699	<b>6056</b>	6412	6835	7848	9000
	TT58192-RC	723	<b>6153</b>	6546	7043	8121	9435
	TT58216-RC	851	<b>6820</b>	7213	7710	8788	10102
	TT58240-RC	899	<b>6932</b>	7377	7934	9128	10872
	Top: 2 piece; Base: 3 RC						
	TT58288-RC	1148	<b>9958</b>	10354	11294	12154	14745
	Top: 3 piece; Base: 4 RC						

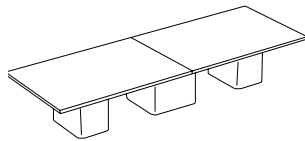

TT58168-RC

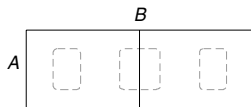

Model Numbers:  
Shape A B Base  
e.g. TT 58 168 RC

**IMPORTANT:** Tables are standard with wood grain running length of table.

**Notes:**

- Conference tables are shipped RTA (ready to assemble)

**Options**

*Options are built-in at factory*

Grommets . . . . . see page at end of this section

**Options**

*Options are built-in at factory*

INLAY -available ONLY with Detailed or larger edge

- INP Black 3mm (1/8") Inlay
- INB Brushed Brass 3mm Inlay or
- INC Satin Chrome 3mm Inlay

Rectangle top with Bow End or C3R options uses the 'shape inlay' price.

When a Rectangular table top is ordered with 2000 Series edge and an inlay, please add the optional Bow End (BE) or the Corners with 3" Radius (C3R).

## Conference Tables

### Rectangular - Triangle Base

Description	Model Number	Wgt	List Prices				
			WoodPlus	Standard	Detailed	2000	3000
<b>36" wide, 18" wide base</b>	TT3672-TRI	246	<b>2849</b>	3013	3181	3871	4392
	Top: 1 piece; Base: 2 TRI						
	TT4272-TRI	261	<b>3050</b>	3214	3382	4072	4593
	TT4284-TRI	279	<b>3474</b>	3674	3939	4800	5245
<b>48" wide 24" wide base</b>	TT4296-TRI	296	<b>3541</b>	3741	4006	4867	5312
	Top: 1 piece; Base: 2 TRI						
	TT4872-TRI	304	<b>3050</b>	3214	3382	4072	4593
	Top: 1 piece; Base: 2 TRI						
<b>58" wide 30" wide base</b>	TT4884-TRI	324	<b>3474</b>	3674	3939	4800	5245
	TT4896-TRI	344	<b>3541</b>	3741	4006	4867	5312
	TT48120-TRI	424	<b>4005</b>	4239	4562	5673	6385
	Top: 1 piece; Base: 2 TRI. 120" long may be specified as 2 piece top.						
	TT48144-TRI	516	<b>4590</b>	4894	5258	6343	7264
<b>58" wide 30" wide base</b>	TT48150-TRI	526	<b>5512</b>	5816	6180	7265	8186
	TT48168-TRI	556	<b>5520</b>	5876	6299	7312	8464
	Top: 2 piece; Base: 3 TRI						
	TT58120-TRI	466	<b>4122</b>	4356	4679	5790	6502
	Top: 1 piece; Base: 2 TRI. 120" long may be specified as 2 piece top.						
	TT58144-TRI	554	<b>4611</b>	4915	5279	6364	7285
	TT58150-TRI	566	<b>5628</b>	5932	6296	7381	8302
	Top: 2 piece; Base: 2 TRI						
	TT58168-TRI	674	<b>5960</b>	6316	6739	7752	8904
	TT58180-TRI	699	<b>6056</b>	6412	6835	7848	9000
<b>58" wide 30" wide base</b>	TT58192-TRI	723	<b>6153</b>	6546	7043	8121	9435
	TT58216-TRI	851	<b>6820</b>	7213	7710	8788	10102
	TT58240-TRI	899	<b>6932</b>	7377	7934	9128	10872
	Top: 2 piece; Base: 3 TRI						
	TT58288-TRI	1148	<b>9958</b>	10354	11294	12154	14745
	Top: 3 piece; Base: 4 TRI						

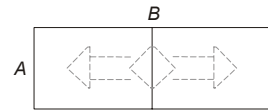
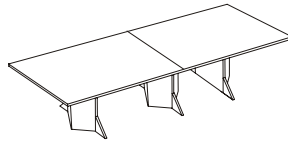
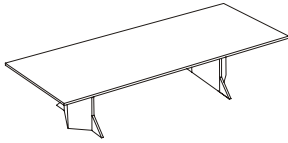

ACT Model Numbers:  
Shape A B Base  
e.g. TT 58 168 RC

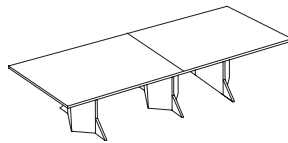

**IMPORTANT: Tables are standard with wood grain running length of table.**

#### Edge Options Information

Tables are available with the following edge options:

- WoodPlus 3 mm PVC edge
- Standard 3 mm Wood Edge
- Detailed 3/8" Wood Edge
- 2000 Series hardwood edges
- 3000 Series hardwood edges

Edge Options Information	WoodPlus 3 mm PVC	Standard Wood	Detailed Wood	2000 Wood	3000 Wood
Equations	WPES	Equations SWES	RE	2000	1000
Modular 8	WPER	Modular 8 SWER	RA	2001	1100
WPMS	WPEN	SWMS	BE	2002	1200
WPMN		SWMN	TR	2003	2200
WPMR		SWMR	CL	2004	2100

## Conference Tables

### Rectangular - Panel End Base

Description	Model Number	Wgt	List Prices					
			WoodPlus	Standard	Wood Edges			
					Detailed	2000	3000	
<b>36" wide, 18" wide base</b>	TT3672-PEB	130	<b>1125</b>	1181	1348	1782	2043	
	Top: 1 piece; Base: 2 PEB							
<b>42" wide 20" wide base</b>	TT4272-PEB	145	<b>1283</b>	1339	1506	1940	2201	
	TT4284-PEB	166	<b>1442</b>	1553	1810	2434	2866	
	TT4296-PEB	186	<b>1758</b>	1869	2126	2750	3182	
Top: 1 piece; Base: 2 PEB								
<b>48" wide 24" wide base</b>	TT4872-PEB	160	<b>1447</b>	1503	1670	2104	2365	
	TT4884-PEB	183	<b>1533</b>	1644	1901	2525	2957	
	TT4896-PEB	206	<b>1878</b>	1989	2246	2870	3302	
	TT48120-PEB	250	<b>2286</b>	2467	2843	3883	4598	
	Top: 1 piece; Base: 2 PEB. 120" long may be specified as 2 piece top.							
	TT48144-PEB	312	<b>2598</b>	2807	3266	4465	5247	
	TT48150-PEB	323	<b>2841</b>	3050	3509	4708	5490	
	TT48168-PEB	355	<b>3048</b>	3288	3822	5131	5992	
	Top: 2 piece; Base: 3 PEB.							
<b>58" wide 30" wide base</b>	TT58120-PEB	310	<b>2432</b>	2613	2989	4029	4744	
	Top: 1 piece; Base: 2 PEB. 120" long may be specified as 2 piece top.							
	TT58144-PEB	389	<b>2760</b>	2969	3428	4627	5409	
	TT58150-PEB	402	<b>2999</b>	3208	3667	4866	5648	
	TT58168-PEB	440	<b>3240</b>	3480	4014	5323	6184	
	TT58180-PEB	468	<b>3562</b>	3802	4336	5645	6506	
	TT58192-PEB	495	<b>3919</b>	4203	4777	6166	7201	
	TT58216-PEB	549	<b>4311</b>	4595	5169	6558	7593	
	Top: 2 piece; Base: 3 PEB.							
	<b>Grommets in PEB base</b>	GR-PEB-END		48	48	48	48	48
A GROMMET which is centered 'side to side' and located near the end panel at the end of the table, will be placed on the 'outside' of the end panel, to avoid any interference from the stretcher placed between end panels.								
	GR-PEB-CENTER		216	216	216	216	216	
To place a GROMMET in the center of the table (both 'side to side' and 'end to end') the single stretcher between end panels will be changed to two stretchers between end panels. This second stretcher is included in the GR-PEB-CENTER price.								

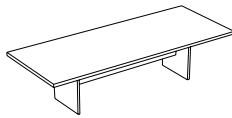

TT48120-PEB

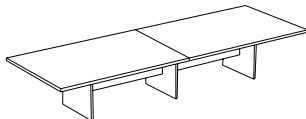

TT58168-PEB

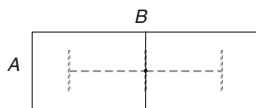

Model Numbers:  
Shape A B Base  
e.g. TT 58 168 PEB

**IMPORTANT:** Tables are standard with wood grain running length of table.

**Notes:**

- Conference tables are shipped RTA (ready to assemble)

**Options**

Options are built-in at factory

Grommets . . . . . see page at end of this section

**Options**

Options are built-in at factory

INLAY -available ONLY with Detailed or larger edge

- INP Black 3mm (1/8") Inlay
- INB Brushed Brass 3mm Inlay or
- INC Satin Chrome 3mm Inlay

Rectangle top with Bow End or C3R options uses the 'shape inlay' price.

When a Rectangular table top is ordered with 2000 Series edge and an inlay, please add the optional Bow End (BE) or the Corners with 3" Radius (C3R).

## Conference Tables

### Boat Shape - Radius Cube Base

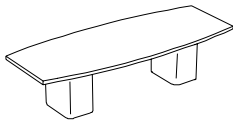

TB48120-RC

Description	Model Number	Wgt	List Prices				
			WoodPlus	Standard	Detailed	2000	3000
<b>36" wide, 18" wide base</b>	TB3672-RC Top: 1 piece; Base: 2 RC	246	<b>3081</b>	3276	3649	4325	4847
<b>42" wide 18" wide base</b>	TB4272-RC TB4284-RC TB4296-RC Top: 1 piece; Base: 2 RC	261 279 296	<b>3251</b> <b>3539</b> <b>3829</b>	3446 3739 4029	3819 4207 4497	4495 5088 5378	5017 5533 5823
<b>48" wide 24" wide base</b>	TB4872-RC Top: 1 piece; Base: 2 RC	304	<b>3421</b>	3616	3989	4665	5187
	TB4884-RC TB4896-RC TB48120-RC Top: 1 piece; Base: 2 RC. 120" long may be specified as 2 piece top.	324 344 424	<b>3725</b> <b>4030</b> <b>4336</b>	3925 4230 4570	4393 4698 5004	5274 5579 6267	5719 6024 6938
	TB48144-RC TB48150-RC TB48168-RC Top: 2 piece; Base: 3 RC.	516 526 556	<b>4672</b> <b>5646</b> <b>5656</b>	4968 5942 6014	5451 6425 6546	6772 7746 7962	7680 8654 8934
<b>58" wide 30" wide base</b>	TB58120-RC Top: 1 piece; Base: 2 RC. 120" long may be specified as 2 piece top.	466	<b>4740</b>	4974	5408	6671	7342
	TB58144-RC TB58150-RC Top: 2 piece; Base: 2 RC.	554 566	<b>5076</b> <b>5763</b>	5372 6059	5855 6542	7176 7863	8084 8771
	TB58168-RC TB58180-RC TB58192-RC TB58216-RC TB58240-RC Top: 2 piece; Base: 3 RC	674 699 723 851 899	<b>6096</b> <b>6790</b> <b>7019</b> <b>7250</b> <b>7480</b>	6454 7148 7481 7712 7947	6986 7680 8021 8252 8593	8402 9096 9489 9720 10393	9374 10068 10635 10866 11754
	TB58288-RC Top: 3 piece; Base: 4 RC	1148	<b>9972</b>	10368	11530	13389	15093

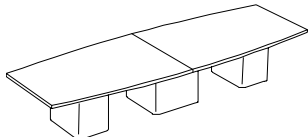

TB58168-RC

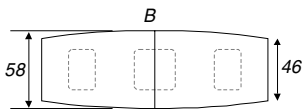

Model Numbers:  
Shape 58 B Base  
e.g. TB 58 168 RC

**IMPORTANT: Tables are standard with wood grain running length of table.**

#### Edge Options Information

Tables are available with the following edge options:

- WoodPlus 3 mm PVC edge
- Standard 3 mm Wood Edge
- Detailed 3/8" Wood Edge
- 2000 Series hardwood edges
- 3000 Series hardwood edges

Edge Options Information	WoodPlus 3 mm PVC	Standard Wood	Detailed Wood	2000 Wood	3000 Wood
Equations WPES	Equations SWES	RE	2000	1000	3200
Modular 8 WPER	Modular 8 SWER	RA	2001	1100	3400
WPMS	SWMS	BE	2002	1200	
WPMN	SWMN	TR	2003	2200	
WPMR	SWMR	CL	2004	2100	

## Conference Tables

### Boat Shape - Triangle Base

Description	Model Number	Wgt	List Prices				
			WoodPlus	Standard	Wood Edges		
					Detailed	2000	3000
<b>36" wide,</b> <b>18" wide base</b>	TB3672-TRI Top: 1 piece; Base: 2 TRI	246	<b>3081</b>	3276	3649	4325	4847
<b>42" wide</b> <b>18" wide base</b>	TB4272-TRI TB4284-TRI TB4296-TRI Top: 1 piece; Base: 2 TRI	261 279 296	<b>3251</b> <b>3539</b> <b>3829</b>	3446 3739 4029	3819 4207 4497	4495 5088 5378	5017 5533 5823
<b>48" wide</b> <b>24" wide base</b>	TB4872-TRI Top: 1 piece; Base: 2 TRI	304	<b>3421</b>	3616	3989	4665	5187
	TB4884-TRI TB4896-TRI TB48120-TRI Top: 1 piece; Base: 2 TRI. 120" long may be specified as 2 piece top.	324 344 424	<b>3725</b> <b>4030</b> <b>4336</b>	3925 4230 4570	4393 4698 5004	5274 5579 6267	5719 6024 6938
	TB48144-TRI TB48150-TRI TB48168-TRI Top: 2 piece; Base: 3 TRI.	516 526 556	<b>4672</b> <b>5646</b> <b>5656</b>	4968 5942 6014	5451 6425 6546	6772 7746 7962	7680 8654 8934
<b>58" wide</b> <b>30" wide base</b>	TB58120-TRI Top: 1 piece; Base: 2 TRI. 120" long may be specified as 2 piece top.	466	<b>4740</b>	4974	5408	6671	7342
	TB58144-TRI TB58150-TRI Top: 2 piece; Base: 2 TRI.	554 566	<b>5076</b> <b>5763</b>	5372 6059	5855 6542	7176 7863	8084 8771
	TB58168-TRI TB58180-TRI TB58192-TRI TB58216-TRI TB58240-TRI Top: 2 piece; Base: 3 TRI	674 699 723 851 899	<b>6096</b> <b>6790</b> <b>7019</b> <b>7250</b> <b>7480</b>	6454 7148 7481 7712 7947	6986 7680 8021 8252 8593	8402 9096 9489 9720 10393	9374 10068 10635 10866 11754
	TB58288-TRI Top: 3 piece; Base: 4 TRI	1148	<b>9972</b>	10368	11530	13389	15093

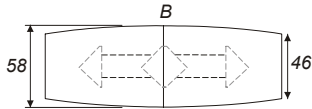
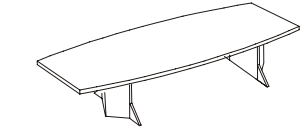

Model Numbers:  
Shape width B Base  
e.g. TB 58 168 TRI

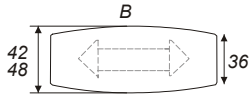

Model Numbers:  
Shape width B Base  
e.g. TB 48 120 TRI



**IMPORTANT: Tables are standard with wood grain running length of table.**

#### Notes:

- Conference tables are shipped RTA (ready to assemble)

#### Options

Options are built-in at factory

Grommets ..... see page at end of this section

#### Options

Options are built-in at factory

INLAY -available ONLY with Detailed or larger edge

INP Black 3mm (1/8") Inlay

INB Brushed Brass 3mm Inlay or

INC Satin Chrome 3mm Inlay

Rectangle top with Bow End or C3R options uses the 'shape inlay' price.

When a Rectangular table top is ordered with 2000 Series edge and an inlay, please add the optional Bow End (BE) or the Corners with 3" Radius (C3R).

# Conference Tables

## Boat Shape - Panel End Base

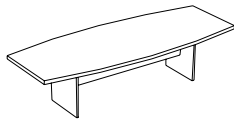

TB48120-PEB

Description	Model Number	Wgt	List Prices				
			WoodPlus	Standard	Detailed	2000	3000
<b>36" wide, 18" wide base</b>	TB3672-PEB	130	<b>1785</b>	1938	2309	3029	3551
Top: 1 piece; Base: 2 PEB							
<b>42" wide 18" wide base</b>	TB4272-PEB	145	<b>1846</b>	1999	2370	3090	3612
	TB4284-PEB	166	<b>1909</b>	2076	2546	3458	3903
	TB4296-PEB	186	<b>2159</b>	2326	2796	3708	4153
Top: 1 piece; Base: 2 PEB							
<b>48" wide 24" wide base</b>	TB4872-PEB	160	<b>1941</b>	2094	2465	3185	3707
	TB4884-PEB	183	<b>2008</b>	2175	2645	3557	4002
	TB4896-PEB	206	<b>2273</b>	2440	2910	3822	4267
	TB48120-PEB	250	<b>2804</b>	3038	3472	4735	5406
Top: 1 piece; Base: 2 PEB. 120" long may be specified as 2 piece top.							

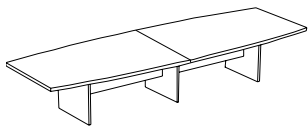

TB58168-PEB

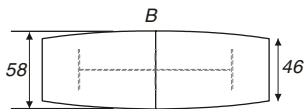

Model Numbers:  
Shape 58 B Base  
e.g. TT 58 168 PEB

<b>58" wide 30" wide base</b>	TB58120-PEB	310	<b>3067</b>	3301	3735	4998	5669
Top: 1 piece; Base: 2 PEB. 120" long may be specified as 2 piece top.							
	TB58144-PEB	389	<b>3249</b>	3502	4028	5349	6257
	TB58150-PEB	402	<b>3405</b>	3658	4184	5505	6413
	TB58168-PEB	440	<b>3558</b>	3837	4448	5864	6836
	TB58180-PEB	468	<b>3919</b>	4198	4809	6225	7197
	TB58192-PEB	495	<b>4311</b>	4645	5313	6781	7927
	TB58216-PEB	549	<b>4741</b>	5075	5743	7211	8357
Top: 2 piece; Base: 3 PEB.							

### Grommets in PEB base

GR-PEB-END	48	48	48	48	48
------------	----	----	----	----	----

A GROMMET which is centered 'side to side' and located near the end panel at the end of the table, will be placed on the 'outside' of the end panel, to avoid any interference from the stretcher placed between end panels.

GR-PEB-CENTER	216	216	216	216	216
---------------	-----	-----	-----	-----	-----

To place a GROMMET in the center of the table (both 'side to side' and 'end to end') the single stretcher between end panels will be changed to two stretchers between end panels. This second stretcher is included in the GR-PEB-CENTER price.

### Double or Twin Modesty Panels

TWIN-PEB-2BASES	168	196	196	196	196
TWIN-PEB-3BASES	336	364	364	392	392

PEB-TWIN-MP-2 option

Grommet locations shown

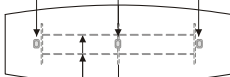

Adding a second MP creates a 10" wide wire channel

**IMPORTANT: Tables are standard with wood grain running length of table.**

### Edge Options Information

Tables are available with the following edge options:

- WoodPlus 3 mm PVC edge
- Standard 3 mm Wood Edge
- Detailed 3/8" Wood Edge
- 2000 Series hardwood edges
- 3000 Series hardwood edges

Edge Options Information	WoodPlus 3 mm PVC	Standard Wood	Detailed Wood	2000 Wood	3000 Wood
Equations	WPES	Equations	RE	2000	1000
Modular 8	WPER	Modular 8	RA	2001	1100
	WPEN		BE	2002	1200
			TR	2003	2200
			CL	2004	2100
					3200
					3400

## Conference Tables

### Racetrack - Full Cylinder Base

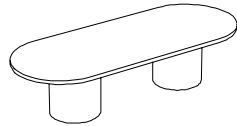

TR48120-CYL

Description	Model Number	Wgt	List Prices				
			WoodPlus	Standard	Wood Edges		
					Detailed	2000	3000
<b>42" wide</b>	TR4284-CYL	279	<b>3539</b>	3739	4207	5088	5533
<b>18" wide base</b>	TR4296-CYL	296	<b>3829</b>	4029	4497	5378	5823

Top: 1 piece; Base: 2 CYL

<b>48" wide</b>	TR4896-CYL	316	<b>4030</b>	4230	4698	5579	6024
<b>24" wide base</b>	TR48120-CYL	396	<b>4336</b>	4570	5004	6267	6938

Top: 1 piece; Base: 2 CYL. 120" long may be specified as 2 piece top.

	TR48144-CYL	474	<b>4672</b>	4968	5451	6772	7680
	TR48150-CYL	484	<b>4932</b>	5228	5711	7032	7940

Top: 2 piece; Base: 2 CYL

	TR48168-CYL	514	<b>4932</b>	5290	5822	7238	8210
--	-------------	-----	-------------	------	------	------	------

Top: 2 piece; Base: 3 CYL

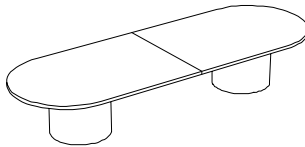

TR58168-CYL

<b>58" wide</b>	TR58120-CYL	426	<b>4740</b>	4974	5408	6671	7342
<b>30" wide base</b>							

Top: 1 piece; Base: 2 CYL. 120" long may be specified as 2 piece top.

	TR58144-CYL	514	<b>5076</b>	5372	5855	7176	8084
--	-------------	-----	-------------	------	------	------	------

	TR58150-CYL	526	<b>5359</b>	5655	6138	7459	8367
--	-------------	-----	-------------	------	------	------	------

	TR58168-CYL	614	<b>5359</b>	5717	6249	7665	8637
--	-------------	-----	-------------	------	------	------	------

Top: 2 piece; Base: 2 CYL

	TR58180-CYL	639	<b>6790</b>	7148	7680	9096	10068
--	-------------	-----	-------------	------	------	------	-------

	TR58192-CYL	663	<b>7019</b>	7481	8021	9489	10635
--	-------------	-----	-------------	------	------	------	-------

	TR58216-CYL	791	<b>7250</b>	7712	8252	9720	10866
--	-------------	-----	-------------	------	------	------	-------

	TR58240-CYL	839	<b>7480</b>	7947	8593	10393	11754
--	-------------	-----	-------------	------	------	-------	-------

Top: 2 piece; Base: 3 CYL

	TR58288-CYL	1068	<b>9458</b>	9854	11016	12875	14579
--	-------------	------	-------------	------	-------	-------	-------

Top: 3 piece; Base: 4 CYL

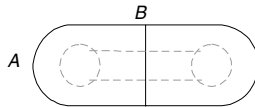

Model Numbers:  
Shape A B Base  
e.g. TR 58 168 CYL

**IMPORTANT:** Tables are standard with wood grain running length of table.

#### Notes:

- Conference tables are shipped RTA (ready to assemble)

#### Options

Options are built-in at factory

Grommets ..... see page at end of this section

#### Options

Options are built-in at factory

INLAY -available ONLY with Detailed or larger edge

INP Black 3mm (1/8") Inlay

INB Brushed Brass 3mm Inlay or

INC Satin Chrome 3mm Inlay

Rectangle top with Bow End or C3R options uses the 'shape inlay' price.

When a Rectangular table top is ordered with 2000 Series edge and an inlay, please add the optional Bow End (BE) or the Corners with 3" Radius (C3R).

## Conference Tables

Description	Model Number	Wgt	List Prices				
			WoodPlus	Standard	Detailed	2000	3000
<b>Racetrack - Half Cylinder Base</b>							
<b>36" or 42" wide, 18" wide base</b>	TR3672-HC	246	<b>2671</b>	2866	3239	3915	4437
	TR4272-HC	261	<b>2864</b>	3059	3432	4108	4630
	TR4284-HC	279	<b>3010</b>	3210	3678	4559	5004
	TR4296-HC	296	<b>3157</b>	3357	3825	4706	5151
<b>48" wide 24" wide base</b>	TR4872-HC	276	<b>2912</b>	3107	3480	4156	4678
	TR4884-HC	296	<b>3059</b>	3259	3727	4608	5053
	TR4896-HC	316	<b>3205</b>	3405	3873	4754	5199
	TR48120-HC	424	<b>3500</b>	3734	4168	5431	6102
Top: 1 piece; Base: 2 HC							
	TR48144-HC	516	<b>3866</b>	4162	4645	5966	6874
	TR48150-HC	526	<b>4004</b>	4300	4783	6104	7012
	TR48168-HC	514	<b>4932</b>	5290	5822	7238	8210
Top: 2 piece; Base: 2 HC, 1 CYL							
<b>58" wide 30" wide base</b>	TR58120-HC	446	<b>4740</b>	4974	5408	6671	7342
Top: 1 piece; Base: 2 HC. 120" long may be specified as 2 piece top.							
	TR58144-HC	514	<b>5076</b>	5372	5855	7176	8084
	TR58150-HC	526	<b>5359</b>	5655	6138	7459	8367
	TR58168-HC	614	<b>5359</b>	5717	6249	7665	8637
Top: 2 piece; Base: 2 HC, 1 CYL							
	TR58180-HC	639	<b>6790</b>	7148	7680	9096	10068
	TR58192-HC	663	<b>7019</b>	7481	8021	9489	10635
	TR58216-HC	791	<b>7250</b>	7712	8252	9720	10866
	TR58240-HC	839	<b>7480</b>	7947	8593	10393	11754
Top: 2 piece; Base: 2 HC, 1 CYL							
	TR58288-HC	1068	<b>9458</b>	9854	11016	12875	14579
Top: 3 piece; Base: 2 HC, 2 CYL							

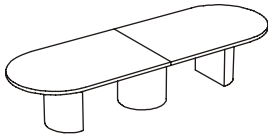
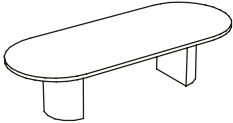
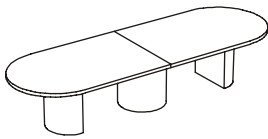
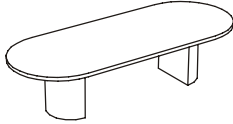

**IMPORTANT: Tables are standard with wood grain running length of table.**

### Edge Options Information

Tables are available with the following edge options:

- WoodPlus 3 mm PVC edge
- Standard 3 mm Wood Edge
- Detailed 3/8" Wood Edge
- 2000 Series hardwood edges
- 3000 Series hardwood edges

Edge Options Information	WoodPlus 3 mm PVC	Standard Wood	Detailed Wood	2000 Wood	3000 Wood
	Equations WPES	Equations SWES	RE	2000	1000
	Modular 8 WPER	Modular 8 SWER	RA	2001	1100
	WPMS	SWMS	BE	2002	1200
	WPMN	SWMN	TR	2003	2200
	WPMR	SWMR	CL	2004	2100
					3200
					3400



## Conference Tables

### Delta - Radius Cube Base

Description	Model Number	Wgt	List Prices				
			WoodPlus	Standard	Wood Edges		
					Detailed	2000	3000
<b>58" wide</b>	TDE5896-RC	417	<b>5155</b>	5389	5823	7086	7757
<b>One piece top</b>	TDE58120-RC	466	<b>5523</b>	5757	6191	7454	8125
Top: 1 piece; Base: 2 RC. 120 long may be specified as 2 piece top.							
<b>Two piece top</b>	TDE58144-RC	554	<b>5894</b>	6190	6673	7994	8902
	TDE58150-RC	566	<b>6207</b>	6503	6986	8307	9215
Top: 2 piece; Base: 2 RC							
	TDE58168-RC	674	<b>6207</b>	6565	7097	8513	9485
	TDE58180-RC	699	<b>7778</b>	8136	8668	10084	11056
	TDE58192-RC	723	<b>8032</b>	8494	9034	10502	11648

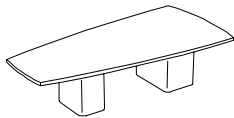

TDE58120-RC

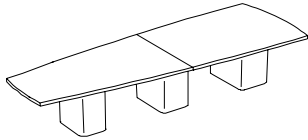

TDE58168-RC

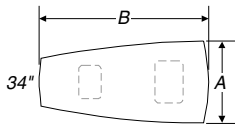

Model Numbers:  
Shape A B Base  
e.g. TDE 58 120 RC

### Egg Shape - Radius Half Cylinder Base

<b>58" wide</b>	TEG5896-RHC	417	<b>5413</b>	5647	6081	7344	8015
Top: 1 piece; Base: 2 RHC							

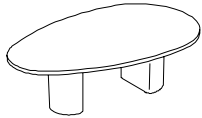

TEG5896-RHC

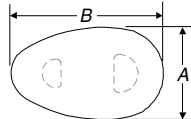

Model Numbers:  
Shape A B Base  
e.g. TEG 58 96 RHC

**IMPORTANT:** Tables are standard with wood grain running length of table.

#### Notes:

- Conference tables are shipped RTA (ready to assemble)

#### Options

Options are built-in at factory

Grommets ..... see page at end of this section

#### Options

Options are built-in at factory

INLAY -available ONLY with Detailed or larger edge

INP Black 3mm (1/8") Inlay

INB Brushed Brass 3mm Inlay or

INC Satin Chrome 3mm Inlay

Rectangle top with Bow End or C3R options uses the 'shape inlay' price.

When a Rectangular table top is ordered with 2000 Series edge and an inlay, please add the optional Bow End (BE) or the Corners with 3" Radius (C3R).

## Conference Tables

### Round - Full Cylinder Base

Description	Model Number	Wgt	List Prices				
			WoodPlus	Standard	Detailed	2000	3000
<b>58" diameter</b>	TD58-CYL	204	<b>2015</b>	2215	2683	3564	4009

Single piece top; 30" diameter base  
 Note: Table requires counterweight for stability. Bags provided for sand (sand not included)

<b>66" diameter</b>	TD66-CYL	241	<b>3157</b>	3453	3936	5257	6165
---------------------	----------	-----	-------------	------	------	------	------

2 piece top; 36" diameter base

<b>72" diameter</b>	TD72-CYL	292	<b>3157</b>	3453	3936	5257	6165
---------------------	----------	-----	-------------	------	------	------	------

2 piece top; 36" diameter base

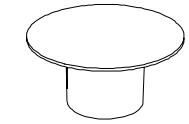

TD58-CYL

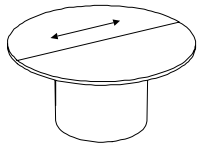

TD72-CYL

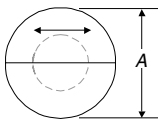

ACT Model Numbers:  
 Shape A Base  
 e.g. TD-72-CYL

### Wing Conference table - Radius Cube base

<b>Wing table</b>	TW-1712-RC	1446	<b>12251</b>	13186	14254	17191	19483
-------------------	------------	------	--------------	-------	-------	-------	-------

WING table seats 16 to 18.  
 Table is 16' - 10" long by 12' - 3" wide.  
 Minimum room size is 25' long by 20' wide.

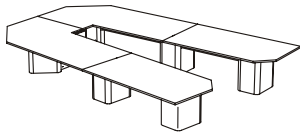

'WING' Conference table  
 with RC Radius Cube bases

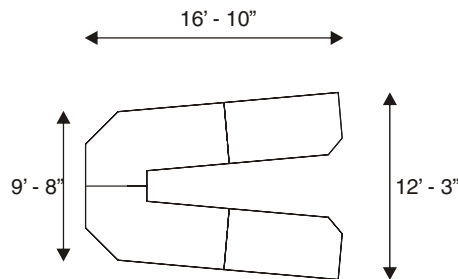
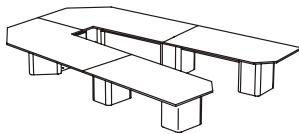

Overall table space :  
 25' long by 20' minimum

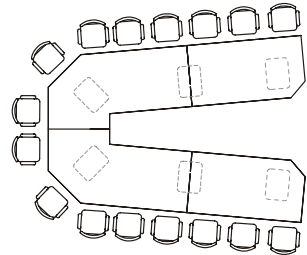

Seats 16 at table

**IMPORTANT: Tables are standard with wood grain running length of table.**

#### Edge Options Information

Tables are available with the following edge options:

- WoodPlus 3 mm PVC edge
- Standard 3 mm Wood Edge
- Detailed 3/8" Wood Edge
- 2000 Series hardwood edges
- 3000 Series hardwood edges

Edge Options Information	WoodPlus 3 mm PVC	Standard Wood	Detailed Wood	2000 Wood	3000 Wood
Equations WPES	Equations SWES	RE	2000	1000	3200
Modular 8 WPER	Modular 8 SWER	RA	2001	1100	3400
WPMS	SWMS	BE	2002	1200	
WPMN	SWMN	TR	2003	2200	
WPMR	SWMR	CL	2004	2100	

## Conference Tables - WoodPlus<sup>2</sup>

Description	Model No.	Overall Dimensions		Wgt	List Prices WoodPlus <sup>2</sup>
		Deep	Long		

### WoodPlus<sup>2</sup> Rectangular Bow End Tables with Radius Cube Base

<b>36" wide</b>	TT-BE-3672-RC-WP2	36	72	246	<b>2633</b>
-----------------	-------------------	----	----	-----	-------------

Top: 1 piece; Base: 2 Radius Cubes

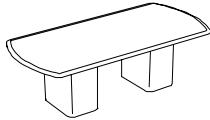

TT-BE-4696-RC

<b>42" wide</b>	TT-BE-4272-RC-WP2	42	72	261	<b>2761</b>
-----------------	-------------------	----	----	-----	-------------

	TT-BE-4284-RC-WP2	42	84	279	<b>2935</b>
--	-------------------	----	----	-----	-------------

	TT-BE-4296-RC-WP2	42	96	296	<b>3333</b>
--	-------------------	----	----	-----	-------------

Top: 1 piece; Base: 2 Radius Cubes



<b>46" wide</b>	TT-BE-4672-RC-WP2	46	72	304	<b>3043</b>
-----------------	-------------------	----	----	-----	-------------

	TT-BE-4684-RC-WP2	46	84	324	<b>3217</b>
--	-------------------	----	----	-----	-------------

	TT-BE-4696-RC-WP2	46	96	344	<b>3440</b>
--	-------------------	----	----	-----	-------------

Top: 1 piece; Base: 2 Radius Cubes.

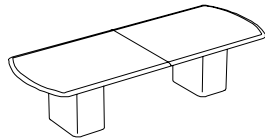

TT-BE-46120-RC

	TT-BE-46120-RC-WP2	46	120	424	<b>4471</b>
--	--------------------	----	-----	-----	-------------

Top: 2 piece; Base: 2 Radius Cubes.

Metal stretchers included to support top span and joint.

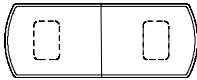

	TT-BE-46144-RC-WP2	46	144	516	<b>5181</b>
--	--------------------	----	-----	-----	-------------

	TT-BE-46150-RC-WP2	46	150	526	<b>5292</b>
--	--------------------	----	-----	-----	-------------

	TT-BE-46168-RC-WP2	46	168	556	<b>5629</b>
--	--------------------	----	-----	-----	-------------

Top: 2 piece; Base: 3 Radius Cubes

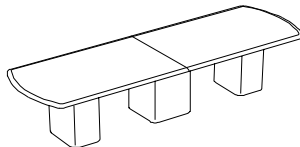

TT-BE-46144-RC

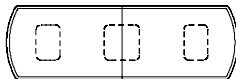

#### Order information:

Qty	Model Number	Top finish	Base finish	Options
1	TR-46120-TA-WP2	WP2-81	CG1	
1	TT-BE-42120-RC-WP2	WP2-81	WP2-81	
2	TB-BE-46168-RC-WP2	CP2-38	CP2-88	
1	TD-42D-TA-WP2	CP2-38	CG1	
2	TR-42144-HC-WP2	CP2-38	CP2-88	
1	TEG-4676-RHC-WP2	WP2-81	WP2-81	

#### Notes

Tables are shipped  
RTA (ready to assemble)

#### Important:

**WoodPlus<sup>2</sup> Conference Tables are standard with wood grain running length of table.**

## Conference Tables - WoodPlus<sup>2</sup>

Description      Model No.      Overall Dimensions  
Deep      Long      Wgt      List Prices  
WoodPlus<sup>2</sup>

### WoodPlus<sup>2</sup> Boat Bow End Table with Radius Cube Base

**36" Wide**      TB-BE-3672-RC-WP2      36      72      246      **2633**  
Top: 1 piece; Base: 2 Radius Cubes

**42" Wide**      TB-BE-4272-RC-WP2      42      72      261      **2761**  
TB-BE-4284-RC-WP2      42      84      279      **2935**  
TB-BE-4296-RC-WP2      42      96      296      **3333**  
Top: 1 piece; Base: 2 Radius Cubes

**46" Wide**      TB-BE-4672-RC-WP2      46      72      304      **3043**  
TB-BE-4684-RC-WP2      46      84      324      **3217**  
TB-BE-4696-RC-WP2      46      96      344      **3440**  
Top: 1 piece; Base: 2 Radius Cubes

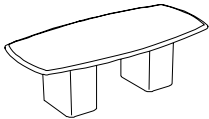

TB-BE-4696-RC

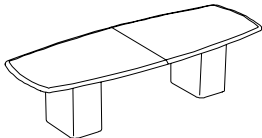

TB-BE-46120-RC

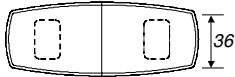

TB-BE-46120-RC-WP2      46      120      424      **4471**

Top: 2 piece; Base: 2 Radius Cubes.

Metal stretchers included to support top span and joint.

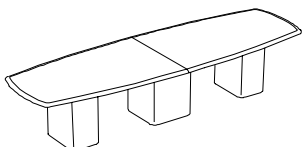

TB-BE-46144-RC

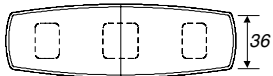

TB-BE-46144-RC-WP2      46      144      516      **5181**

TB-BE-46150-RC-WP2      46      150      526      **5292**

TB-BE-46168-RC-WP2      46      168      556      **5629**

Top: 2 piece; Base: 3 Radius Cubes

#### WoodPlus<sup>2</sup> ACT Table Top Finishes

WP2-41 Natural Maple  
WP2-81 Fusion Maple  
WP2-45 Anigre  
WP2-61 Pear  
WP2-31 Medium Cherry  
WP2-71 Dark Cherry  
CP2-28 Medium Grey Speckle  
CP2-38 Beige Speckle

#### WoodPlus<sup>2</sup> XTRA tops only (see upcharges)

WP2-18 Shadow Oak  
WP2-65 Beech  
CP2-72 Shark Gray  
CP2-74 Platinum  
CP2-78 Bronze  
CP2-80 Cashmere Fiber

#### WoodPlus<sup>2</sup> Table base Finishes

ColorPlus<sup>2</sup> finishes for BASE only are

WP2-41 Natural Maple  
WP2-81 Fusion Maple  
WP2-45 Anigre  
WP2-61 Pear  
WP2-31 Medium Cherry  
WP2-71 Dark Cherry  
CP2-88 Black  
CP2-98 Slate  
CP2-76 Espresso

#### Tangent base finish

Charcoal Gray

#### TABLE EDGES WOODPLUS<sup>2</sup> or COLORPLUS<sup>2</sup>

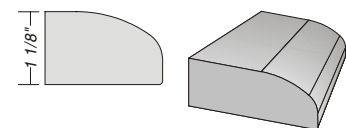

## Conference Tables - WoodPlus<sup>2</sup>

Description	Model No.	Overall Dimensions		Wgt	List Prices
		Deep	Long		WoodPlus <sup>2</sup>

### WoodPlus<sup>2</sup> Racetrack Table with Half Cylinder Base

<b>36" wide</b>	TR-3672-HC-WP2	36	72	246	<b>2330</b>
-----------------	----------------	----	----	-----	-------------

Top: 1 piece; Base: 2 Half Cylinders

<b>42" wide</b>	TR-4272-HC-WP2	42	72	261	<b>2330</b>
-----------------	----------------	----	----	-----	-------------

	TR-4284-HC-WP2	42	84	279	<b>2446</b>
--	----------------	----	----	-----	-------------

	TR-4296-HC-WP2	42	96	296	<b>2757</b>
--	----------------	----	----	-----	-------------

Top: 1 piece; Base: 2 Half Cylinders

<b>46" wide</b>	TR-4672-HC-WP2	46	72	276	<b>2359</b>
-----------------	----------------	----	----	-----	-------------

	TR-4684-HC-WP2	46	84	296	<b>2532</b>
--	----------------	----	----	-----	-------------

	TR-4696-HC-WP2	46	96	316	<b>2866</b>
--	----------------	----	----	-----	-------------

Top: 1 piece; Base: 2 Half Cylinders

No RHC Radius Half Cylinder option available on TR-4672-HC-WP2 table.

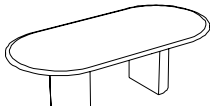

TR-4696-HC

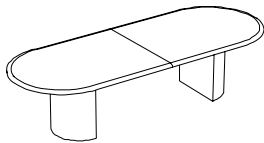

TR-46120-HC

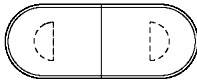

	TR-46120-HC-WP2	46	120	424	<b>3787</b>
--	-----------------	----	-----	-----	-------------

Top: 2 piece; Base: 2 Half Cylinders.

Metal stretchers included to support top span and joint.

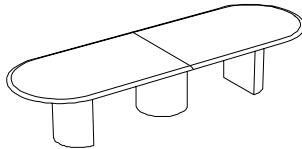

TR-46144-HC

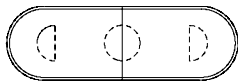

	TR-46144-HC-WP2	46	144	516	<b>4282</b>
--	-----------------	----	-----	-----	-------------

	TR-46150-HC-WP2	46	150	526	<b>4394</b>
--	-----------------	----	-----	-----	-------------

	TR-46168-HC-WP2	46	168	546	<b>4772</b>
--	-----------------	----	-----	-----	-------------

Top: 2 piece; Base: 2 Half Cylinders, Center Cylinder.

Table at 168" long includes metal stretchers to support top span.

#### Order information:

Qty	Model Number	Top finish	Base finish	Options
1	TR-46120-TA-WP2	WP2-81	CG1	
1	TT-BE-42120-RC-WP2	WP2-81	WP2-81	
2	TB-BE-46168-RC-WP2	CP2-38	CP2-88	
1	TD-42D-TA-WP2	CP2-38	CG1	
2	TR-42144-HC-WP2	CP2-38	CP2-88	
1	TEG-4676-RHC-WP2	WP2-81	WP2-81	

#### Notes

Tables are shipped RTA (ready to assemble)

#### Important:

**WoodPlus<sup>2</sup> Conference Tables are standard with wood grain running length of table.**

## Conference Tables - WoodPlus<sup>2</sup>

Description	Model No.	Overall Dimensions		Wgt	List Prices WoodPlus <sup>2</sup>
		Deep	Long		

### WoodPlus<sup>2</sup> Racetrack Table with Full Cylinder Base

42" wide	TR-4284-CYL-WP2	42	84	279	<b>2700</b>
	TR-4296-CYL-WP2	42	96	296	<b>2881</b>

Top: 1 piece; Base: 2 Cylinders

46" wide	TR-4696-CYL-WP2	42	96	316	<b>3011</b>
----------	-----------------	----	----	-----	-------------

Top: 1 piece; Base: 2 Cylinders

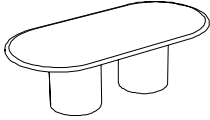

TR-4696-CYL

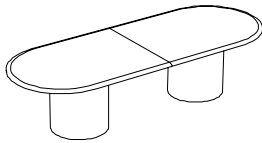

TR-46120-CYL

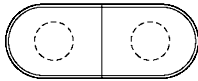

	TR-46120-CYL-WP2	46	120	396	<b>4042</b>
--	------------------	----	-----	-----	-------------

Top: 2 piece; Base: 2 Cylinders.

Metal stretchers included to support top span and joint.

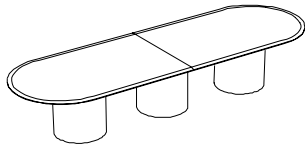

TR-46144-CYL

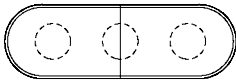

	TR-46144-CYL-WP2	46	144	474	<b>4517</b>
--	------------------	----	-----	-----	-------------

	TR-46150-CYL-WP2	46	150	484	<b>4652</b>
--	------------------	----	-----	-----	-------------

	TR-46168-CYL-WP2	46	168	514	<b>4986</b>
--	------------------	----	-----	-----	-------------

Top: 2 piece; Base: 3 Cylinders

#### WoodPlus<sup>2</sup> ACT Table Top Finishes

WP2-41 Natural Maple  
 WP2-81 Fusion Maple  
 WP2-45 Anigre  
 WP2-61 Pear  
 WP2-31 Medium Cherry  
 WP2-71 Dark Cherry  
 CP2-28 Medium Grey Speckle  
 CP2-38 Beige Speckle

#### WoodPlus<sup>2</sup> XTRA tops only (see upcharges)

WP2-18 Shadow Oak  
 WP2-65 Beech  
 CP2-72 Shark Gray  
 CP2-74 Platinum  
 CP2-78 Bronze  
 CP2-80 Cashmere Fiber

#### WoodPlus<sup>2</sup> Table base Finishes

ColorPlus<sup>2</sup> finishes for BASE only are

WP2-41 Natural Maple  
 WP2-81 Fusion Maple  
 WP2-45 Anigre  
 WP2-61 Pear  
 WP2-31 Medium Cherry  
 WP2-71 Dark Cherry  
 CP2-88 Black  
 CP2-98 Slate  
 CP2-76 Espresso

#### Tangent base finish

Charcoal Gray

#### TABLE EDGES WOODPLUS<sup>2</sup> or COLORPLUS<sup>2</sup>

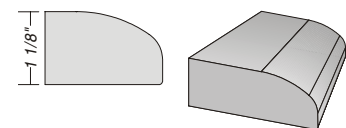

## Conference Tables - WoodPlus<sup>2</sup>

Description      Model No.      Overall Dimensions  
Deep      Long      Wgt      List Prices  
WoodPlus<sup>2</sup>

### WoodPlus<sup>2</sup> 'Egg' Table with Radius Half Cylinder Base

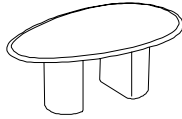

TEG-4676-RHC

<b>46" wide</b>	TEG-4676-RHC-WP2	46	76	286	<b>2496</b>
Top: 1 piece; Base: 2 Radius Half Cylinders					

### WoodPlus<sup>2</sup> Round Tables



TD-46-COLX

<b>Round,</b>	TD-42D-COLX-WP2	42	42	76	<b>1010</b>
<b>Column X Base</b>	TD-46D-COLX-WP2	46	46	96	<b>1120</b>

Base finish is Black or Silver powdercoat.  
(No Grommet option available)

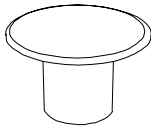

TD-46-CYL

<b>Round,</b>	TD-42D-CYL-WP2	42	42	140	<b>1298</b>
<b>Cylinder Base</b>	TD-46D-CYL-WP2	46	46	164	<b>1384</b>

42" uses 18" diameter Cylinder; 46" uses 20" diameter Cylinder.

Note: Table requires counterweight for stability. Bags provided for sand (sand not included).

#### Order information:

Qty	Model Number	Top finish	Base finish	Options
1	TR-46120-TA-WP2	WP2-81	CG1	
1	TT-BE-42120-RC-WP2	WP2-81	WP2-81	
2	TB-BE-46168-RC-WP2	CP2-38	CP2-88	
1	TD-42D-TA-WP2	CP2-38	CG1	
2	TR-42144-HC-WP2	CP2-38	CP2-88	
1	TEG-4676-RHC-WP2	WP2-81	WP2-81	

#### Notes

Tables are shipped  
RTA (ready to assemble)

#### Important:

**WoodPlus<sup>2</sup> Conference Tables are standard with wood grain running length of table.**

## Conference Tables - WoodPlus<sup>2</sup>

Description	Model No.	Overall Dimensions		Wgt	List Prices WoodPlus <sup>2</sup>
		Deep	Long		

### Slide tables, WP2 finishes



<b>Table - no casters</b>	SLIDE-3260-EC0-WP2 Legs are silver.	32	60	85	<b>1601</b>
---------------------------	--	----	----	----	-------------



<b>Table - 2 casters</b>	SLIDE-3260-EC2-WP2 Casters are locking. Legs are silver.	32	60	85	<b>1677</b>
--------------------------	--	----	----	----	-------------



<b>Table - 4 casters</b>	SLIDE-3260-EC4-WP2 Casters are locking. Legs are silver.	32	60	85	<b>1764</b>
--------------------------	--	----	----	----	-------------

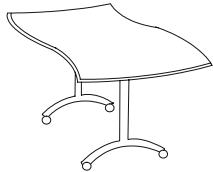

<b>Table - flip top, casters, single release handle</b>	SLIDE-FLIP-3260-ARCHT-CA-WP2 Casters are locking. Please specify legs as black or silver.	32	60	85	<b>2047</b>
---	---	----	----	----	-------------

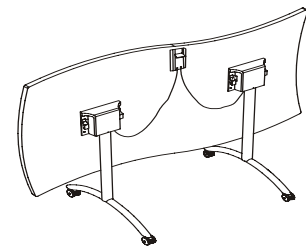
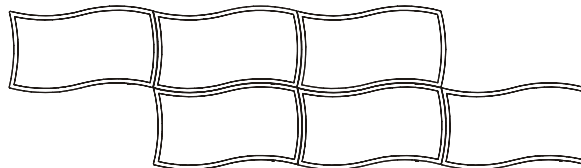
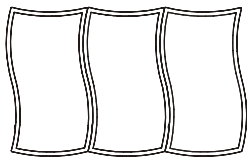
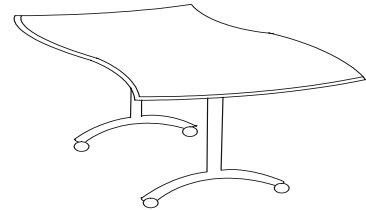
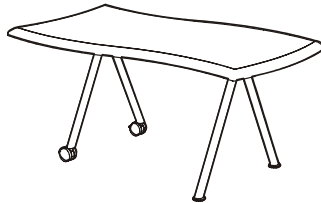
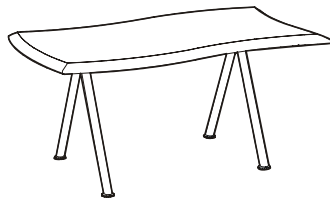

Slide tables may be self-locked together and easily re-configured

#### WoodPlus<sup>2</sup> ACT Table Top Finishes

WP2-41 Natural Maple  
WP2-81 Fusion Maple  
WP2-45 Anigre  
WP2-61 Pear  
WP2-31 Medium Cherry  
WP2-71 Dark Cherry  
CP2-28 Medium Grey Speckle  
CP2-38 Beige Speckle

#### WoodPlus<sup>2</sup> XTRA tops only (see upcharges)

WP2-18 Shadow Oak  
WP2-65 Beech  
CP2-72 Shark Gray  
CP2-74 Platinum  
CP2-78 Bronze  
CP2-80 Cashmere Fiber

#### WoodPlus<sup>2</sup> Table base Finishes

ColorPlus<sup>2</sup> finishes for BASE only are  
WP2-41 Natural Maple  
WP2-81 Fusion Maple  
WP2-45 Anigre  
WP2-61 Pear  
WP2-31 Medium Cherry  
WP2-71 Dark Cherry  
CP2-88 Black  
CP2-98 Slate  
CP2-76 Espresso

#### Tangent base finish

Charcoal Gray

#### TABLE EDGES WOODPLUS<sup>2</sup> or COLORPLUS<sup>2</sup>

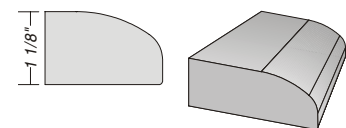



## Options for Conference WoodPlus and WoodPlus2 Tables

Description	Model Number	Dimensions			Wgt	List Price
		Wide	Deep	High		

### **WoodPlus table top INLAYS**

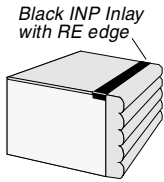

<b>Black, Rectangular</b>	INLAY-RECT-ALL-BLACK	<b>413</b>
---------------------------	----------------------	------------

<b>Black, Shaped</b>	INLAY-SHAPE-ALL-BLACK	<b>712</b>
----------------------	-----------------------	------------

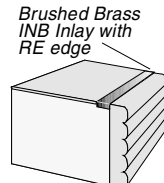

<b>Brass, Rectangular</b>	INLAY-RECT-ALL-BRASS	<b>826</b>
---------------------------	----------------------	------------

<b>Brass, Shaped</b>	INLAY-SHAPE-ALL-BRASS	<b>1409</b>
----------------------	-----------------------	-------------

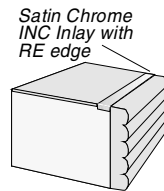

<b>Chrome, Rectangular</b>	INLAY-RECT-ALL-CHROME	<b>826</b>
----------------------------	-----------------------	------------

<b>Chrome, Shaped</b>	INLAY-SHAPE-ALL-CHROME	<b>1409</b>
-----------------------	------------------------	-------------

### **WoodPlus table top 3" radius corners**

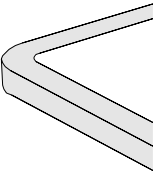

<b>Add Radius</b>	Top-C3R-WPE	<b>412</b>
-------------------	-------------	------------

<b>Corners</b>	Top-C3R-STD	<b>412</b>
----------------	-------------	------------

	Top-C3R-DET	<b>594</b>
--	-------------	------------

	Top-C3R-2000	<b>840</b>
--	--------------	------------

	Top-C3R-3000	<b>840</b>
--	--------------	------------

3 radius on the inside of the edge.

To order add '-C3R' to the end of the table model number.

Rectangular top with Radius corners uses the the Shaped top INLAY upcharge.

### **WoodPlus table top Bow Ends**

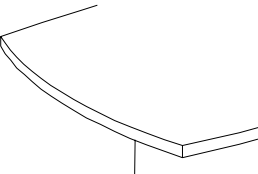

<b>Add Bow Ends</b>	Top-BE-WPE	<b>283</b>
---------------------	------------	------------

	Top-BE-STD	<b>283</b>
--	------------	------------

	Top-BE-DET	<b>283</b>
--	------------	------------

	Top-BE-2000	<b>283</b>
--	-------------	------------

	Top-BE-3000	<b>283</b>
--	-------------	------------

To order add '-BE' to the end of the table model number.

Rectangular top with Bow End uses the Shaped top INLAY charge.

## Options for Conference WoodPlus and WoodPlus2 Tables

Description	Model Number	Dimensions			Wgt	List Price
		Wide	Deep	High		

### Grommets and Inserts



<b>Grommets</b>	GR	4.25	2.75	0		<b>48</b>
-----------------	----	------	------	---	--	-----------

GR = Grommet with cover. Opening: 2 x 3.5

Specify location of grommets, see following page.

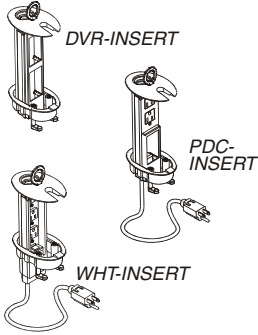

<b>Inserts for above grommets</b>	DVR-INSERT	4.25	2.75	5	1	<b>66</b>
	PDC-INSERT	4.25	2.75	5	1	<b>138</b>
	WHT-INSERT	4.25	2.75	5	1	<b>148</b>

WHT = Work Height Triplex. 6' cord.

WHT pull up size: 2 x 3.5 x 5-1/8 high when extended.

DVR = Data / Voice Receptacle.

DVR pull up size: 2 x 3.5 x 5-1/8 high when extended. DVR is a work surface Pop-up that accepts various receptacle plates to be supplied by your electrical contractor or installer.

**DVR does NOT INCLUDE any receptacles or receptacle plates.**

PDC = Power / Data Combination.

PDC pull up size: 2 x 3.5 x 5-1/8 high when extended. PDC is a work surface pop-up that accepts a combination of Power, Data and Voice (telephone) outlets (up to 2 each).

**PDC does NOT INCLUDE any receptacles or receptacle plates.**

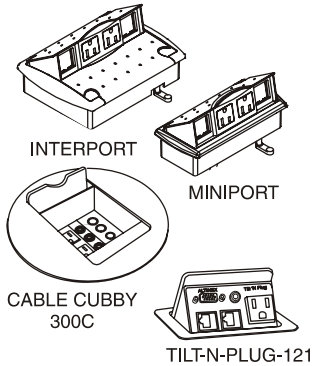

<b>Recessed electrical, data access</b>	MINIPLUG-120	7	3	2	2	<b>197</b>
	MINIPLUG-STARTER-72	7	3	2	2	<b>440</b>
	MINIPLUG-ADDER-48	7	3	2	2	<b>246</b>
	MINIPLUG-ADDER-72	7	3	2	2	<b>246</b>
	MINIPLUG-ADDER-120	7	3	2	2	<b>246</b>
	INTERPORT-PLUG-120	7	5	2	2	<b>236</b>
	INTERPORT-STARTER-72	7	5	2	2	<b>470</b>
	INTERPORT-ADDER-48	7	5	2	2	<b>262</b>
	INTERPORT-ADDER-72	7	5	2	2	<b>262</b>
	INTERPORT-ADDER-120	7	5	2	2	<b>262</b>
	CABLE-CUBBY-300C	6.5	6.5	0	1	<b>1322</b>
	TILT-N-PLUG-121	5	5	0	1	<b>1322</b>
	TILT-N-PLUG-121-UL	5	5	0	1	<b>1502</b>

MINIPLUG-PLUG and INTERPORT-PLUG both house two electrical outlets with 6' cord and two data locations. The receptacle plates for most connectors are included. Electrical outlets with plug ends. **Data connectors are NOT included.**

MINIPLUG and INTERPORT may be setup 'daisy-chained' and hardwired to the building power supply, please contact Customer Service with your requirements.

CABLE-CUBBY-300C has a round faceplate and houses two AC outlets, one video and two audio jacks, up to three sizes of pass through cable openings (using AAP Architectural Adapter Plates). Electrical outlets with plug ends. **Data connectors are NOT included.**

TILT-N-PLUG-121 houses single input plate with Computer Video (15-pin HD), Computer Audio (Stereo Mini), Modem (RJ11), and Network (RJ45) input connections. One electrical outlet with plug end. **Data connectors are NOT included.**

TILT-N-PLUG-121-UL is a UL labeled product with the same configuration as the TILT-N-PLUG-121

Specify location, see following page. When a power - data unit is located directly over a table base, any cutouts in the table base required for the unit to open and close are automatically included.

INTERPORT-PLUG, MINIPLUG-PLUG and TILT-N-PLUG-121 are orientated to the 'side' of the table.

### MINI-ACT options

**For MINI-ACT models, layout and options please see the MINI-ACT section between the ACT tables and the CONFERENCE tables**

# Options for Conference WoodPlus and WoodPlus2 Tables

## CONFERENCE TABLES - GROMMET and BASE HINGED DOOR LOCATIONS

### RADIUS CUBE BASE

TT48120-RC

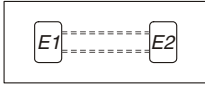

TT48150-RC

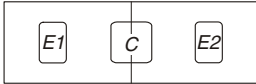

### PANEL END BASE

TB48120-PEB



TB48168-PEB



NOTE: see GR-PEB-END and GR-PEB-CENTER for details

### CYLINDER BASE

TR48150-CYL

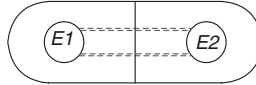

TR48168-CYL

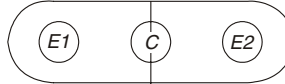

### HALF CYLINDER BASE

TR48120-HC

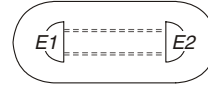

TR48150-HC

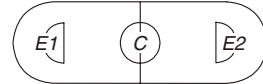

TT58216-RC

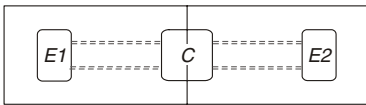

TT58240-RC

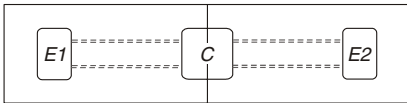

TT58288-RC\*

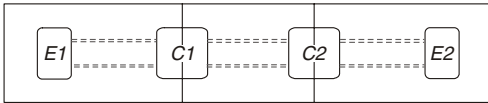

TR58168-CYL

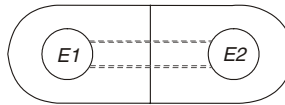

TR58240-CYL

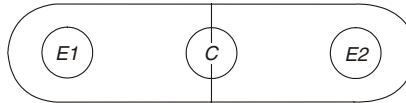

TT58288-CYL\*

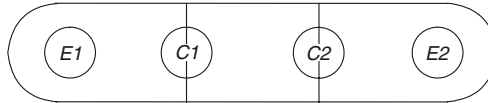

### RADIUS HALF CYLINDER

TEG5896-RHC

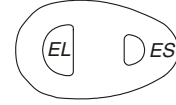

Specify Small or Large End

TDE58144-RC

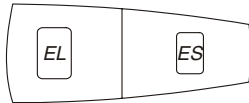

TDE58150-RC

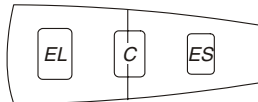

TDE58216-RC

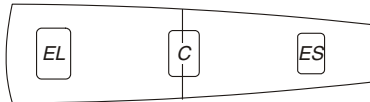

Specify End Large, Center or End Small as shown

TD60-CYL

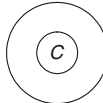

TD66-CYL

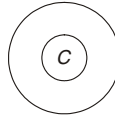

TD72-CYL

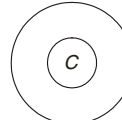

TD with TA base



\*E1 and E2 locations interchangeable except when table requires four bases.

BHD - Base Hinged Door option  
When placing a grommet over an RC, HC, CYL or RHC base, we recommend an optional BHD Base Hinged Door in the base for access to floor monument.

### Tangent Bases

Two Piece Tops, two distinct base structures

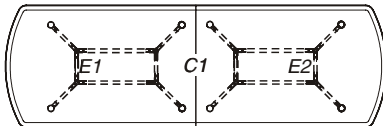

Two Piece Tops, one base structure

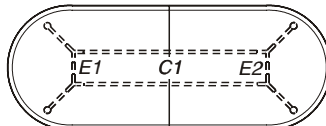

Single Piece tops

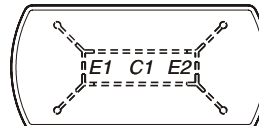

TB-BE-3672-TA  
No Center Grommet

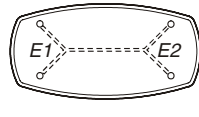

## Options for Conference WoodPlus and WoodPlus2 Tables

### Base Options: Hinged Doors, Notches, Silver or Black Accent

Description	Model Number	Dimensions			Wgt	List Price
		Wide	Deep	High		
<b>Base Hinged Door</b>	BHD-RC	12		12		<b>145</b>
	BHD-HC	12		12		<b>145</b>
	BHD-CYL	12		12		<b>308</b>

To order Base Hinged Doors add to end of the model number  
 BHD-RC on Radius Cube, BHD-HC on Half Cylinder, BHD-RHC on Radius Half Cylinder,  
 BHD-CYL on full Cylinder (used in CYL bases or as the center base on TR...HC tables).

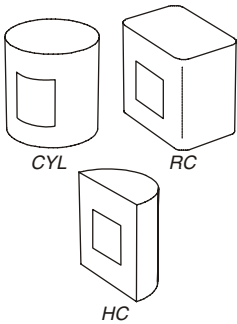

<b>Base wire notch</b>	NU-BASE-NOTCH-UPPER					<b>97</b>
------------------------	---------------------	--	--	--	--	-----------

Notches in both sides of the top edge of the all bases.

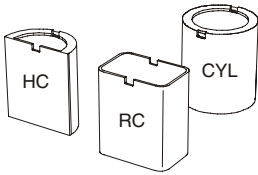

NU Base Notch option for

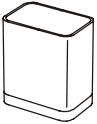

<b>Base Silver Accent</b>	BASE-SILVER-ACCENT-1	add accent to a table with one base				<b>164</b>
	BASE-SILVER-ACCENT-2	add accent to a table with two bases				<b>328</b>
	BASE-SILVER-ACCENT-3	add accent to a table with three bases				<b>492</b>
	BASE-SILVER-ACCENT-4	add accent to a table with four bases				<b>657</b>

Add the 3" accent strip to the bottom of each table base: HC, CYL, RC.

<b>Base Black Accent</b>	BASE-BLACK-ACCENT-1	add accent to a table with one base				<b>111</b>
	BASE-BLACK-ACCENT-2	add accent to a table with two bases				<b>222</b>
	BASE-BLACK-ACCENT-3	add accent to a table with three bases				<b>333</b>
	BASE-BLACK-ACCENT-4	add accent to a table with four bases				<b>445</b>

Add the 3" black accent strip to the bottom of each table base: HC, CYL, RC.

<b>Clam shell base</b>	BASE-CLAM-CONF			48		<b>645</b>
------------------------	----------------	--	--	----	--	------------

Use the clam shell base to protect and hide wiring when the power / wiring access is not located at a table base

Clam Shell shown OPEN and CLOSED

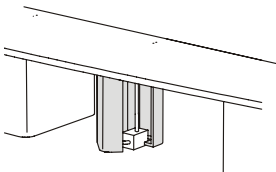
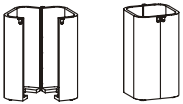

<b>Self-stick Wiremanager</b>	RMN-22	22		1		<b>18</b>
	RMN-96	96		4		<b>49</b>

Extruded PVC with 'double-sided' tape included for installation.

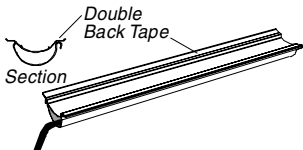

# Modular Conference Tables

## Overview - Modular Conference Tables

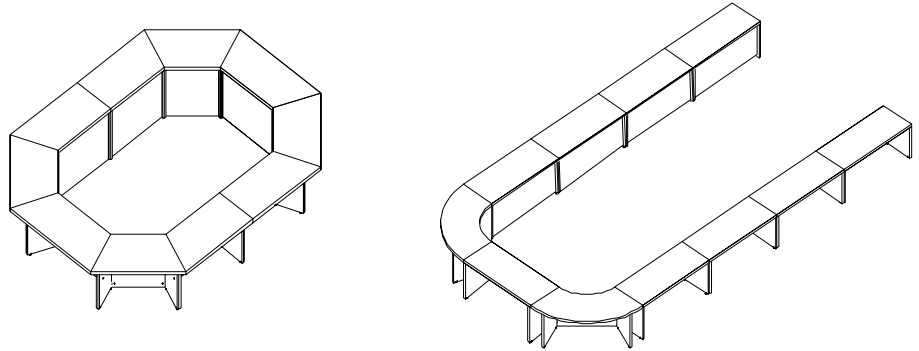

Above configurations are shown in detail on the following pages

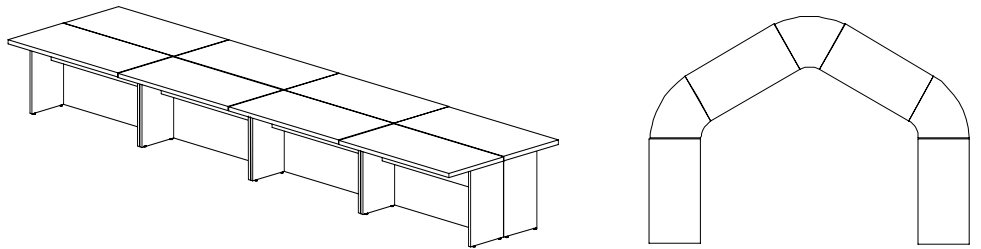

Above configurations are shown in detail on the following pages

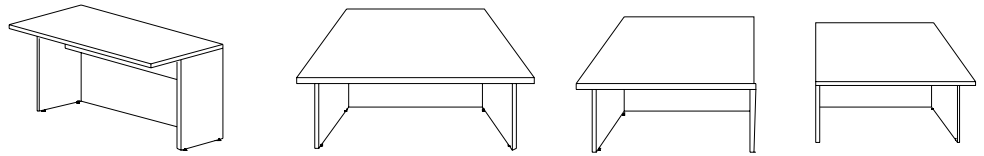

Modular Conference Table SECTIONS, freestanding, see Pg 97

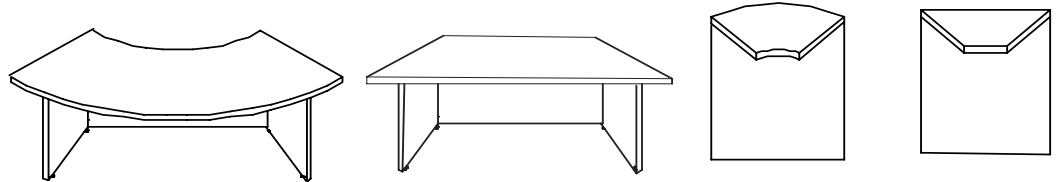

Modular Conference Table FILLERS, requiring support at both ends, see Pg 98

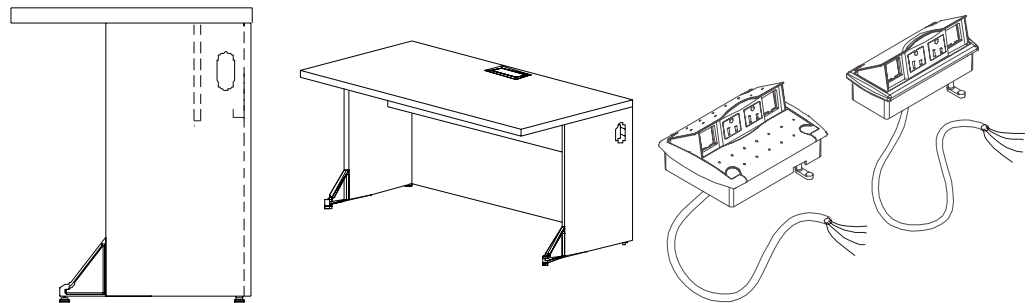

Options and Accessories, see Pg 99

# Modular Conference Tables

## Modular Conference Tables configuration MT-101

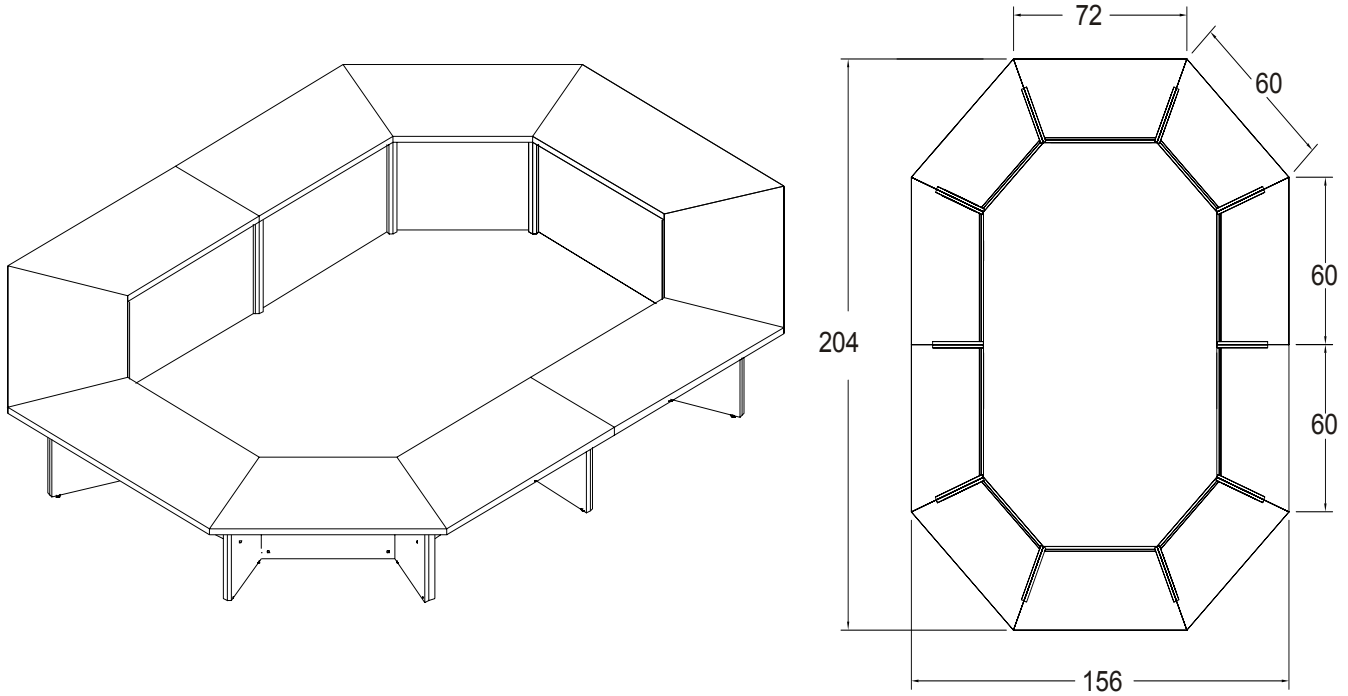

**Overall footprint is 156" wide by 204" long (13' by 17')  
using Trapezoid and Half-trapezoid top shapes  
Seating for 16 to 20 people.**

Description	Model Number	Dimensions			Qty	List Prices		
		Deep	Long	High		WoodPlus	Standard	Wood Edges Detailed
Trapezoid section 72 long	MT-SS-TZ-307229	30	72	29	2	<b>1555</b>	1733	1939
Trapezoid section 60 long	MT-SS-TZ-306029	30	60	29	4	<b>1517</b>	1695	1901
Half-trapezoid section 60 long - LEFT	MT-SS-THL-306029	30	60	29	2	<b>1454</b>	1632	1838
Half-trapezoid section 60 long - RIGHT	MT-SS-THR-306029	30	60	29	2	<b>1454</b>	1632	1838
MT-101						<b>14994</b>	16774	18834

All connecting hardware is included.  
Options and Accessories are available at the end of this section.

### Edge Options Information

Modular tables are available with the following edge options:

- WoodPlus 3 mm PVC edge Laminate Table Tops only
- Standard 3 mm Wood Edge
- Detailed 3/8" Wood Edge

WoodPlus 3 mm PVC	Standard Wood	Detailed Wood
Equations WPES	Equations SWES	RE
Modular 8 WPER	Modular 8 SWER	RA
WPMS	SWMS	BE
WPMN	SWMN	TR
WPMR	SWMR	CL

# Modular Conference Tables

## Modular Conference Tables configuration MT-102

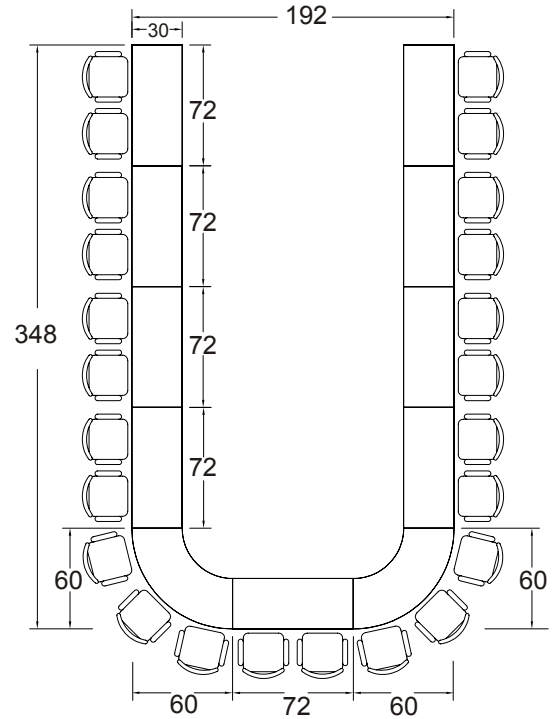
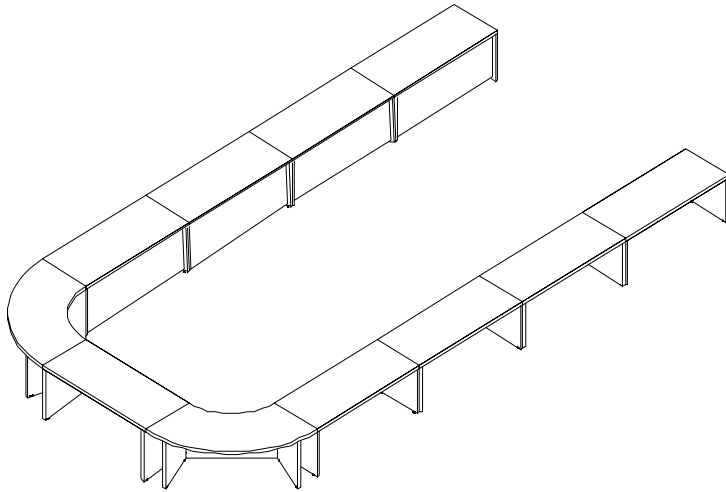

**Overall footprint is 192" wide by 348" long (16' by 29')**  
**Seating for 24 people**

Description	Model Number	Dimensions			Qty	List Prices		
		Deep	Long	High		WoodPlus	Standard	Wood Edges Detailed
Rectangle section - 72 long	MT-SS-TT-307229	30	72	29	9	1345	1526	1711
Curved Corner section	MT-SC-90-606029	60	60	29	2	2449	2594	2780
<b>MT-102</b>						<b>17003</b>	18922	20959

All connecting hardware is included.  
 Options and Accessories are available at the end of this section.

### Notes:

- Modular tables are shipped  
 RTA (ready to assemble)

### Options

Options are built-in at factory

Grommets and Inserts . . . . .  
 see page at end of this section

### INLAY

-available ONLY with Detailed edge

INP Black 3mm (1/8") Inlay:  
 Modular Shaped tops . . . . .

INB Brushed Brass 3mm Inlay or  
 INC Satin Chrome 3mm Inlay:  
 Modular Shaped tops . . . . .

### Options

Options are built-in at factory

See the end of this section for  
 pricing on all options and  
 accessories.

# Modular Conference Tables

## Modular Conference Tables configuration MT-103

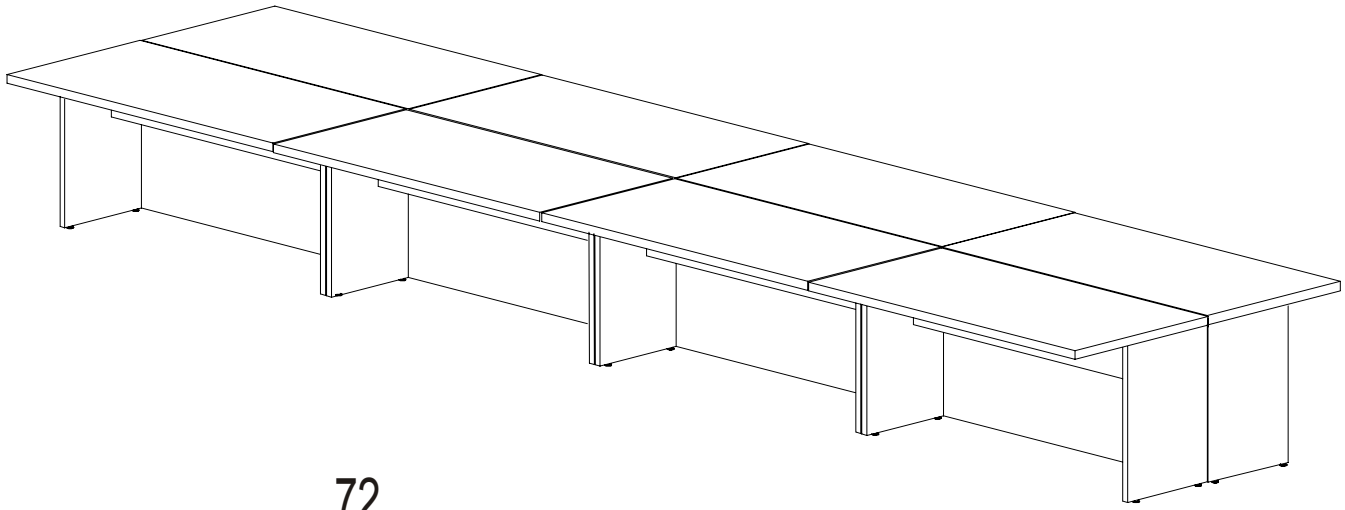

72

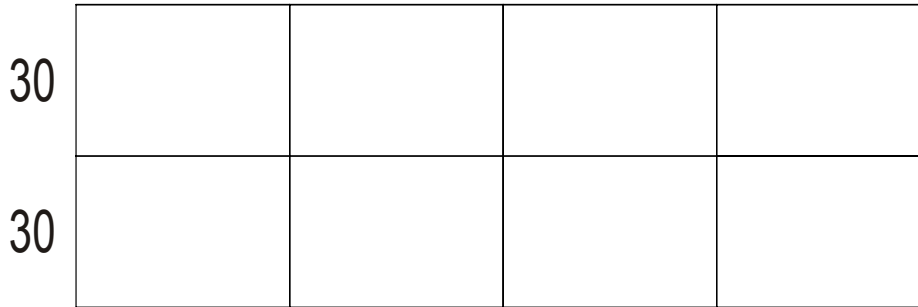

**Overall footprint is 60" by 288" (5' by 24')**  
**Desk top size is 30" x 72"**  
**Seating for 20 people.**

Description	Model Number	Dimensions			Qty	List Prices		
		Deep	Long	High		WoodPlus	Standard	Wood Edges Detailed
Rectangle section - 72 long	MT-SS-TT-307229	30	72	29	8	<b>1345</b>	1523	1729
	MT-103					<b>10760</b>	12184	13832

All connecting hardware is included.  
 Options and Accessories are available at the end of this section.

### Edge Options Information

Modular tables are available with the following edge options:

- WoodPlus 3 mm PVC edge Laminate Table Tops only
- Standard 3 mm Wood Edge
- Detailed 3/8" Wood Edge

WoodPlus 3 mm PVC	Standard Wood	Detailed Wood
Equations WPES	Equations SWES	RE
Modular 8 WPER	Modular 8 SWER	RA
WPMS	SWMS	BE
WPMN	SWMN	TR
WPMR	SWMR	CL



## Modular Conference Tables

### Modular Conference Tables configuration MT-104

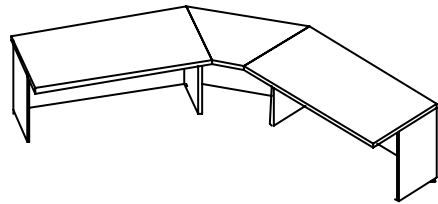

Seating on inside of table.

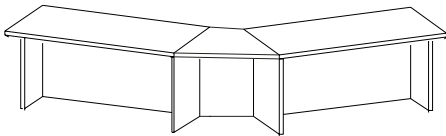

Seating on outside of table.

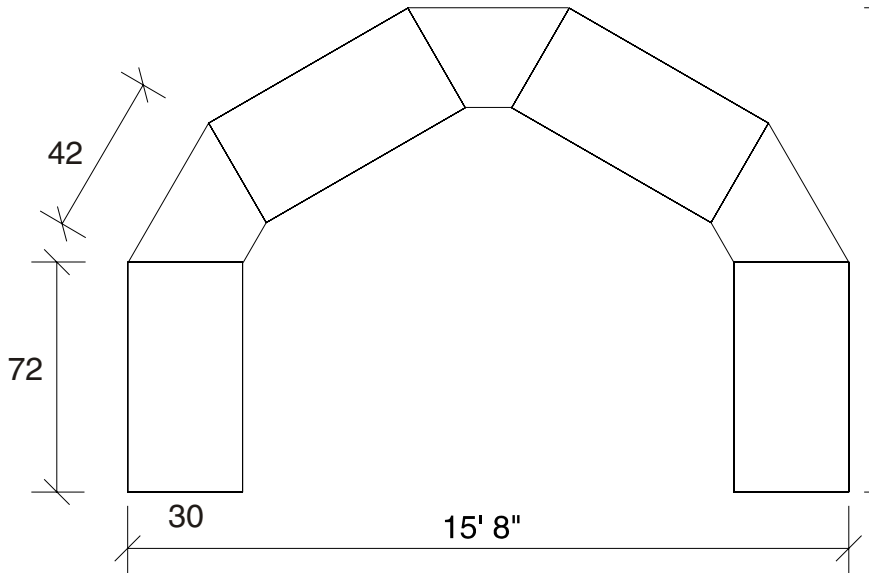

This configuration may be setup to provide either 'inside' or 'outside' seating. Please specify either 'inside' or 'outside' seating when ordering.

**MT-104 footprint is 126" deep by 188" long (10' 6" by 15' 8")**

**Rectangle section is 30" deep by 60" long.**

**Filler Angled is 60 degree angle at 30" deep by 42" long**

**On outside, seating for 11 people.**

**On inside, seating for 8 people.**

Description	Model Number	Dimensions			Qty	List Prices		
		Deep	Long	High		WoodPlus	Standard	Detailed
Rectangle section - 72 long	MT-SS-TT-306029	30	60	29	4	<b>1307</b>	1485	1691
Angled Corner filler - 60 degrees	MT-FA-60-304229	30	42	29	3	<b>720</b>	862	1006
<b>MT-104</b>						<b>7388</b>	8526	9782

All connecting hardware is included.  
Options and Accessories are available at the end of this section.

#### Notes:

- Modular tables are shipped RTA (ready to assemble)

#### Options

Options are built-in at factory

Grommets and Inserts . . . . .  
see page at end of this section

#### INLAY

-available ONLY with Detailed edge

INP Black 3mm (1/8") Inlay:  
Modular Shaped tops . . . . .

INB Brushed Brass 3mm Inlay or  
INC Satin Chrome 3mm Inlay:  
Modular Shaped tops . . . . .

#### Options

Options are built-in at factory

See the end of this section for pricing on all options and accessories.

# Modular Conference Tables

## Modular Conference Tables configuration MT-105

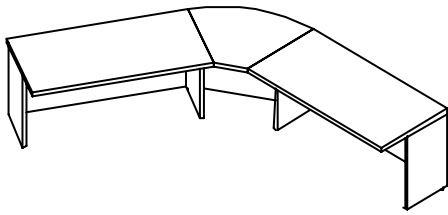

Seating on inside of table.

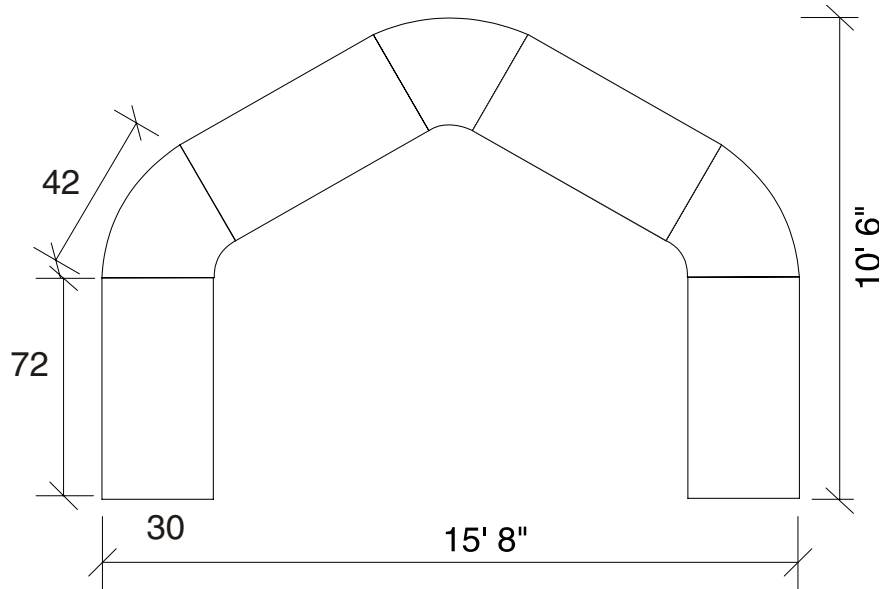

This configuration may be setup to provide either 'inside' or 'outside' seating. Please specify either 'inside' or 'outside' seating when ordering.

**MT-105 footprint is 126" deep by 188" long (10' 6" by 15' 8")**

**Rectangle section is 30" deep by 60" long.**

**Filler Curved is 60 degree angle at 30" deep by 42" long**

**On outside, seating for 11 people.**

**On inside, seating for 8 people.**

Description	Model Number	Dimensions			Qty	List Prices		
		Deep	Long	High		WoodPlus	Standard	Wood Edges Detailed
Rectangle section - 72 long	MT-SS-TT-306029	30	60	29	4	<b>1307</b>	1485	1691
Curved Corner filler - 60 degrees	MT-FC-60-304229	30	42	29	3	<b>747</b>	889	1033
<b>MT-105</b>						<b>7469</b>	8607	9863

All connecting hardware is included.  
Options and Accessories are available at the end of this section.

### Edge Options Information

Modular tables are available with the following edge options:

- WoodPlus 3 mm PVC edge Laminate Table Tops only
- Standard 3 mm Wood Edge
- Detailed 3/8" Wood Edge

WoodPlus 3 mm PVC	Standard Wood	Detailed Wood
Equations WPES	Equations SWES	RE
Modular 8 WPER	Modular 8 SWER	RA
WPMS	SWMS	BE
WPMN	SWMN	TR
WPMR	SWMR	CL

## Modular Conference Tables

### Modular Conference Table SECTIONS, freestanding

Description	Model Number	Dimensions			Wgt	List Prices		
		Deep	Long	High		WoodPlus	Standard	Detailed
<b>Rectangular Sections</b>	MT-SS-TT-306029	30	60	29		<b>1307</b>	1485	1695
	MT-SS-TT-306629	30	66	29		<b>1327</b>	1505	1711
	MT-SS-TT-307229	30	72	29		<b>1345</b>	1539	1729

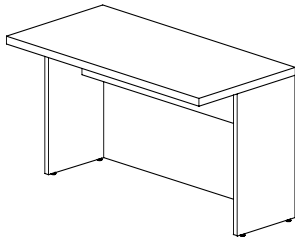

<b>Full trapezoid</b>	MT-SS-TZ-306029	30	60	29		<b>1517</b>	1695	1901
	MT-SS-TZ-306629	30	66	29		<b>1537</b>	1715	1929
	MT-SS-TZ-307229	30	72	29		<b>1555</b>	1733	1939

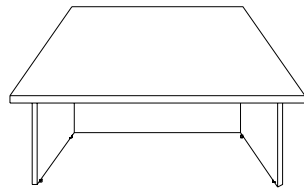

Drawing shows 'back' panel location when seating is on the 'outside' of the layout.

<b>Half trapezoid, angle to LEFT</b>	MT-SS-THL-306029	30	60	29		<b>1454</b>	1632	1858
	MT-SS-THL-306629	30	66	29		<b>1474</b>	1652	1868
	MT-SS-THL-307229	30	72	29		<b>1492</b>	1670	1876

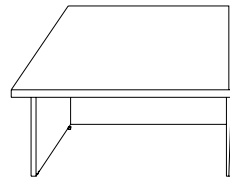

from the 'long' side the angle end is to the LEFT

Drawing shows 'back' panel location when seating is on the 'outside' of the layout.

<b>Half trapezoid, angle to RIGHT</b>	MT-SS-THR-306029	30	60	29		<b>1454</b>	1632	1858
	MT-SS-THR-306629	30	66	29		<b>1474</b>	1652	1868
	MT-SS-THR-307229	30	72	29		<b>1492</b>	1670	1876

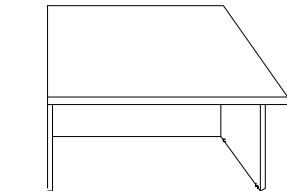

from the 'long' side the angle end is to the RIGHT

Drawing shows 'back' panel location when seating is on the 'outside' of the layout.

Description	Model Number	Deep	Long	High	Angle	Wgt	WoodPlus	Standard	Detailed
<b>Curved Corner Section</b>	MT-SC-90-606029	60	60	29	90		<b>2449</b>	2594	2780
	MT-SC-60-606029			29	60		<b>2549</b>	2694	2880
	MT-SC-45-606029			29	45		<b>2649</b>	2794	2980

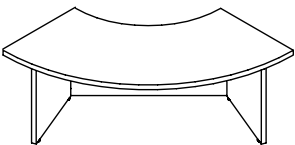

Drawing shows 'back' panel location when seating is on the 'outside' of the layout.

Description	Model Number	Deep	Long	High	Angle	Wgt	WoodPlus	Standard	Detailed
<b>Angled Corner Section</b>	MT-SA-90-606029	60	60	29	90		<b>1811</b>	1956	2142
	MT-SA-60-606029			29	60		<b>1861</b>	2006	2192
	MT-SA-45-606029			29	45		<b>1911</b>	2056	2242

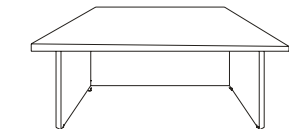

Drawing shows 'back' panel location when seating is on the 'outside' of the layout.

#### Notes:

- Modular tables are shipped RTA (ready to assemble)

#### Options

Options are built-in at factory

Grommets and Inserts . . . . . see page at end of this section

#### INLAY

-available ONLY with Detailed edge

INP Black 3mm (1/8") Inlay:  
Modular Shaped tops . . . . .

INB Brushed Brass 3mm Inlay or  
INC Satin Chrome 3mm Inlay:  
Modular Shaped tops . . . . .

#### Options

Options are built-in at factory

See the end of this section for pricing on all options and accessories.

## Modular Conference Tables

### Modular Conference Table *FILLERS*, requiring support at both ends

Description	Model Number	Dimensions				List Prices		
		Deep	Long	High	Angle	WoodPlus	Standard	Detailed
<b>Filler Curved</b>	MT-FC-90-304229	30	42	29	90	<b>747</b>	889	1033
	MT-FC-60-304229			29	60	<b>747</b>	889	1033
	MT-FC-30-304229			29	45	<b>747</b>	889	1033

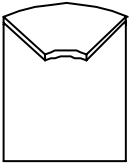

Drawing shows 'back' panel location when seating is on the 'inside' of the layout.  
Fillers are NOT freestanding and require support at both ends.

Description	Model Number	Deep	Long	High	Angle	WoodPlus	Standard	Detailed
					Angle			
<b>Filler Angle</b>	MT-FA-90-304229	30	42	29	90	<b>720</b>	862	1006
	MT-FA-60-304229			29	60	<b>720</b>	862	1006
	MT-FA-30-304229			29	45	<b>720</b>	862	1006

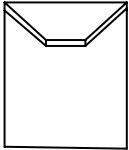

Drawing shows 'back' panel location when seating is on the 'inside' of the layout.  
Fillers are NOT freestanding and require support at both ends.

In these layouts either the 90 degree freestanding SECTIONS or the 90 degree fillers (requiring support at both ends) may be used.

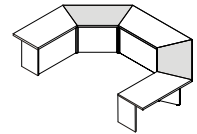
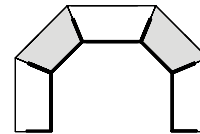
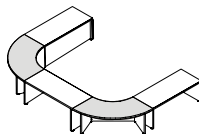
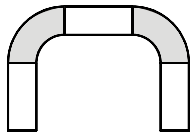

In these layouts either the 60 degree freestanding SECTIONS or the 60 degree fillers (requiring support at both ends) may be used.

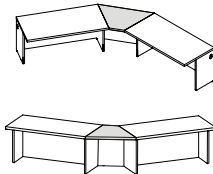
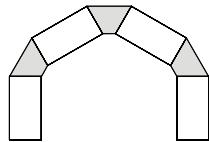

#### Edge Options Information

Modular tables are available with the following edge options:

- WoodPlus 3 mm PVC edge Laminate Table Tops only
- Standard 3 mm Wood Edge
- Detailed 3/8" Wood Edge

	WoodPlus 3 mm PVC	Standard Wood	Detailed Wood
	Equations WPES	Equations SWES	RE
Modular 8	WPER	Modular 8 SWER	RA
	WPMS WPEN	SWMS SWEN	BE
	WPMN	SWMN	TR
	WPMR	SWMR	CL

# Modular Conference Tables

## Options and Accessories

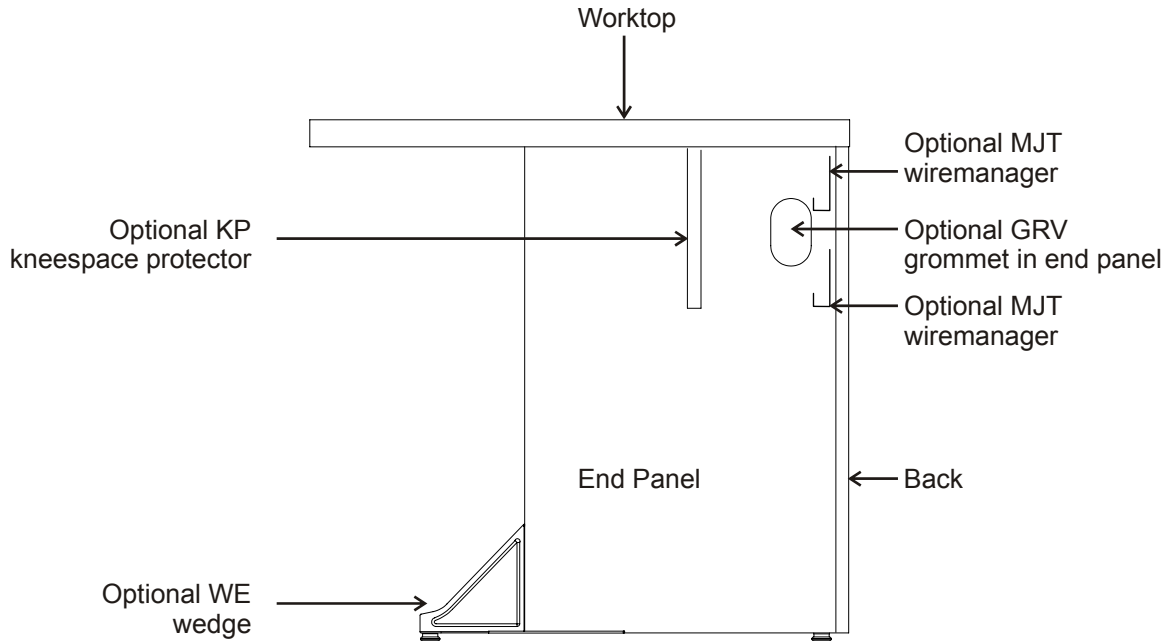

Description	Model Number	Dimensions			Wgt	List Prices		
		Deep	Long	High		Wood Edges		
					WoodPlus	Standard	Detailed	
<b>Kneespace Protectors</b>	MT-KP-60	1	58	28	<b>168</b>	189	189	
	MT-KP-66	1	64	28	<b>168</b>	189	189	
	MT-KP-72	1	70	28	<b>168</b>	189	189	
<b>MJT wiremanager</b>	MJT-48		45		<b>50</b>	50	50	
	MJT-54		51		<b>54</b>	54	54	
	MJT-60		57		<b>58</b>	58	58	
	MJT-66		63		<b>66</b>	66	66	
	MJT-72		69		<b>66</b>	66	66	
		mounts to the inside of the back						
	RMN-22				<b>18</b>	18	18	
	Wiremanager mounted on end panel							
<b>Grommet in end panel</b>	GRV-L				<b>48</b>	48	48	
	GRV-R				<b>48</b>	48	48	

**Notes:**

- Modular tables are shipped RTA (ready to assemble)

**Options**

*Options are built-in at factory*

Grommets and Inserts . . . . . see page at end of this section

**INLAY**

*-available ONLY with Detailed edge*

INP Black 3mm (1/8") Inlay:  
Modular Shaped tops . . . . .

INB Brushed Brass 3mm Inlay or  
INC Satin Chrome 3mm Inlay:  
Modular Shaped tops . . . . .

**Options**

*Options are built-in at factory*

See the end of this section for pricing on all options and accessories.

# Modular Conference Tables

## Options and Accessories

Description	Model Number	Dimensions			Wgt	List Prices		
		Deep	Long	High		Wood Edges		
					WoodPlus	Standard	Detailed	
Wedge on end panel	WEDGE-SILVER-EACH				26	26	26	
	WEDGE-BLACK-EACH				26	26	26	

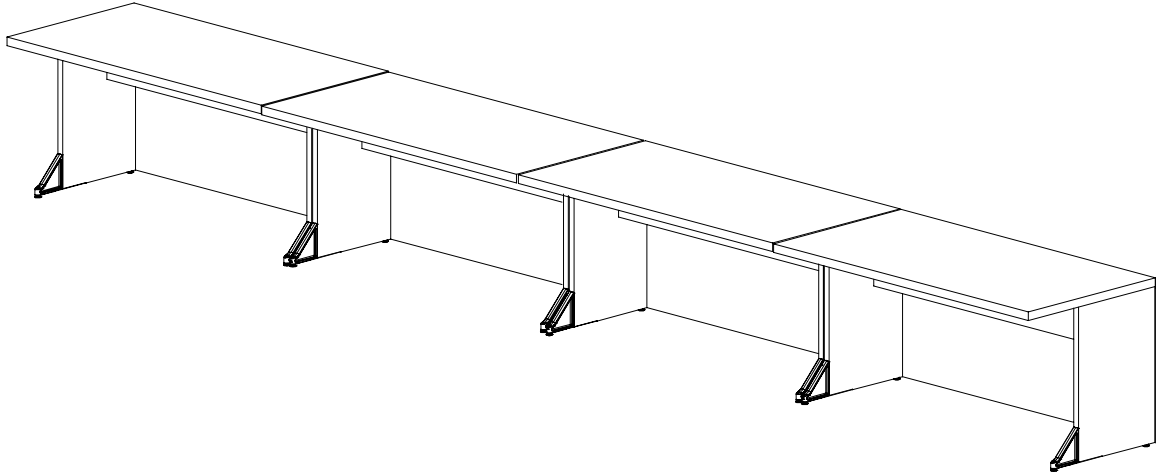

### Edge Options Information

Modular tables are available with the following edge options:

- WoodPlus 3 mm PVC edge  
Laminate Table Tops only
- Standard 3 mm Wood Edge
- Detailed 3/8" Wood Edge

WoodPlus 3 mm PVC	Equations	Standard Wood	Equations	Detailed Wood
	WPES		SWES	RE
Modular 8	WPER	Modular 8	SWER	RA
WPMS	WPEN	SWMS	SWEN	BE
WPMN		SWMN		TR
WPMR		SWMR		CL

# Modular Tables

## Overview - Modular Tables

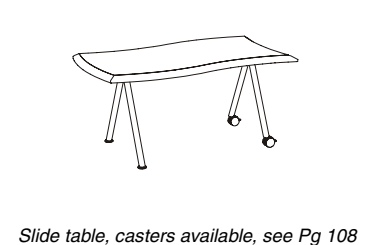
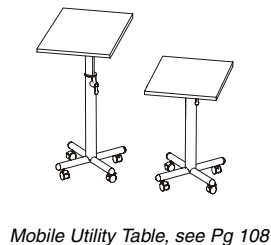
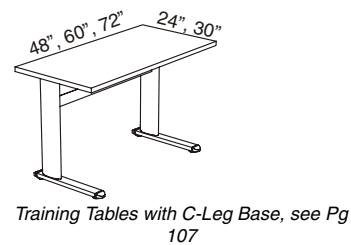
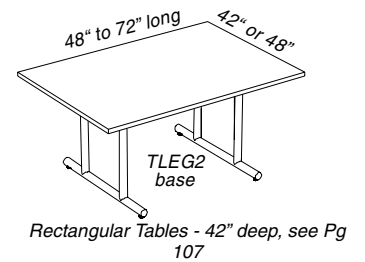
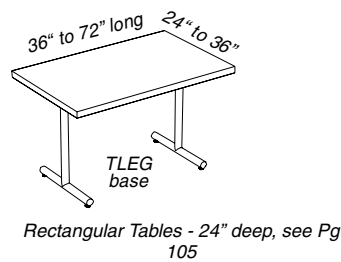
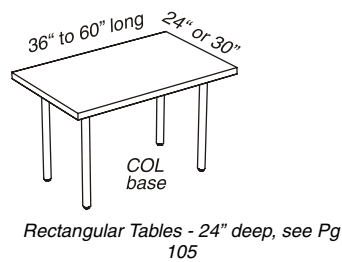
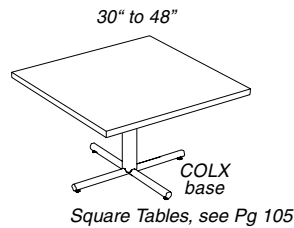
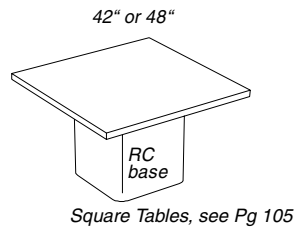
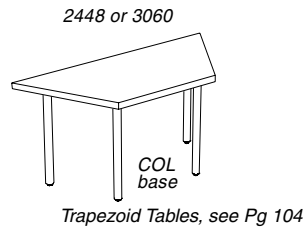
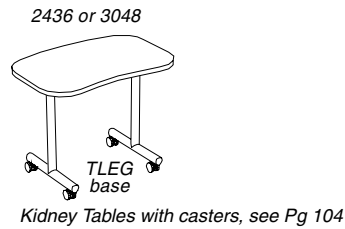
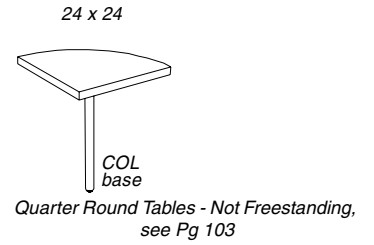
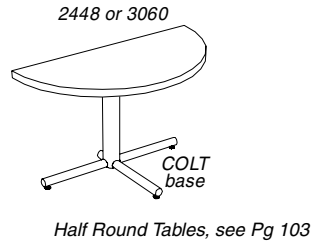
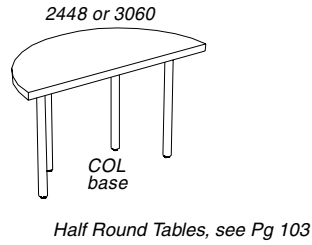
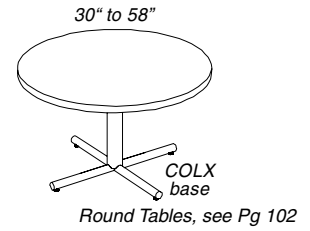
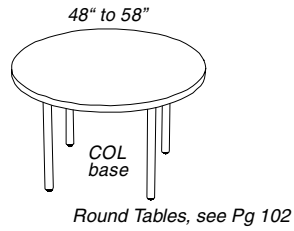
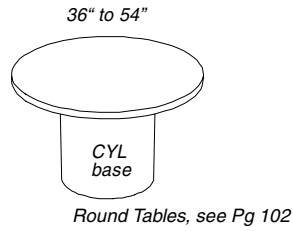

# Modular Tables

## Round Tables

Description	Model Number	Dimensions			Wgt	List Prices		
						WoodPlus	Standard	Detailed
<b>Cylinder Base</b>	TD36-CYL	36	36	29	113	<b>1351</b>	1434	1515
	TD42-CYL	42	42	29	140	<b>1488</b>	1584	1704
	TD48-CYL	48	48	29	155	<b>1535</b>	1631	1751
	TD54-CYL	54	54	29	172	<b>1736</b>	1878	2022
	TD58-CYL	58	58	29	204	<b>2015</b>	2215	2683

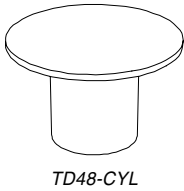

TD36-CYL and TD42-CYL include a sandbag (sand not included), counterweight required for added stability.

<b>2" column legs</b>	TD48-COL	48	48	29	91	<b>1222</b>	1318	1438
	TD54-COL	54	54	29	108	<b>1335</b>	1477	1621
	TD58-COL	58	58	29	126	<b>1487</b>	1629	1773

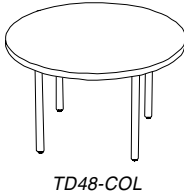

Please specify base finish as black or silver.

<b>with casters</b>	TD48-COL-CA	48	48	29	91	<b>1276</b>	1372	1492
	TD54-COL-CA	54	54	29	108	<b>1428</b>	1570	1714
	TD58-COL-CA	58	58	29	126	<b>1540</b>	1682	1826

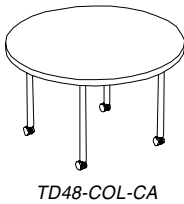

Please specify base finish as black or silver.

<b>X on floor, center column</b>	TD30-COLX	30	30	29	46	<b>994</b>	1077	1158
	TD36-COLX	36	36	29	56	<b>1040</b>	1123	1204
	TD42-COLX	42	42	29	75	<b>1176</b>	1272	1392
	TD48-COLX	48	48	29	93	<b>1245</b>	1341	1461
	TD54-COLX	54	54	29	110	<b>1416</b>	1558	1702
	TD58-COLX	58	58	29	128	<b>1525</b>	1667	1811



Please specify base finish as black or silver.

<b>with casters</b>	TD48-COLX-CA	48	48	29	93	<b>1276</b>	1372	1492
	TD54-COLX-CA	54	54	29	110	<b>1428</b>	1570	1714
	TD58-COLX-CA	58	58	29	128	<b>1540</b>	1682	1826



Please specify base finish as black or silver.

### Edge Options Information

Modular tables are available with the following edge options:

- WoodPlus 3 mm PVC edge Laminate Table Tops only
- Standard 3 mm Wood Edge
- Detailed 3/8" Wood Edge

	WoodPlus 3 mm PVC	Standard Wood	Detailed Wood
	Equations WPES	Equations SWES	RE
Modular 8	WPER	Modular 8 SWER	RA
	WPMS WPEN	SWMS SWEN	BE
	WPMN	SWMN	TR
	WPMR	SWMR	CL



## Modular Tables

### Half Round Tables

Description	Model Number	Dimensions			Wgt	List Prices		
		Wide	Deep	High		WoodPlus	Standard	Detailed
<b>2" column legs</b>	THR2448-COL	48	24	29	68	<b>1008</b>	1040	1224
	THR3060-COL	60	30	29	91	<b>1215</b>	1276	1593

Please specify base finish as black or silver.

<b>with casters</b>	THR2448-COL-CA	48	24	29	68	<b>1102</b>	1134	1318
	THR3060-COL-CA	60	30	29	91	<b>1308</b>	1369	1686

Please specify base finish as black or silver.

<b>T on floor, center column</b>	THR2448-COLT	48	24	29	65	<b>1008</b>	1040	1224
	THR3060-COLT	60	30	29	88	<b>1215</b>	1276	1593
	TC-THR					<b>40</b>	40	40

NOT freestanding; use in an assembly only. Please specify base finish as black or silver.

<b>with casters</b>	THR2448-COLT-CA	48	24	29	65	<b>1102</b>	1134	1318
	THR3060-COLT-CA	60	30	29	88	<b>1308</b>	1369	1686
	TC-THR					<b>40</b>	40	40

NOT freestanding; use in an assembly only. Please specify base finish as black or silver.

### Quarter Round Tables - Not Freestanding

<b>2" column leg</b>	TQR2424-COL	24	24	29	27	<b>598</b>	643	884
	TQR3030-COL	30	30	29	38	<b>774</b>	819	1060
	TC-TQR					<b>40</b>	40	40

Must be ordered with Table Connectors Please specify base finish as black or silver.

<b>with caster</b>	TQR2424-COL-CA	24	24	29	27	<b>622</b>	667	908
	TQR3030-COL-CA	30	30	29	38	<b>797</b>	842	1083
	TC-TQR					<b>40</b>	40	40

Must be ordered with Table Connectors Please specify base finish as black or silver.

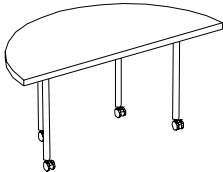
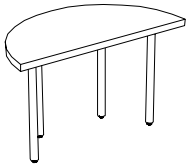

TQR-2424-COL



TQR-2424-COL-CA

#### Notes:

- Modular tables are shipped RTA (ready to assemble)

#### Options

Options are built-in at factory

Grommets

#### INLAY

-available ONLY with Detailed edge

INP Black 3mm (1/8") Inlay:  
Modular Rectangular tops  
Modular Shaped tops

INB Brushed Brass 3mm Inlay or  
INC Satin Chrome 3mm Inlay:  
Modular Rectangular tops  
Modular Shaped tops

#### Accessories

Order separately

TC Table Connectors are available for Modular Tables.

See end of this section for pricing and details.

## Modular Tables

### Kidney Tables with casters

Description	Model Number	Dimensions			Wgt	List Prices		
		Wide	Deep	High		Wood Edges		
					WoodPlus	Standard	Detailed	
<b>inverted 'T' legs with casters</b>	TK2436-TLEG-CA	36	24	29	52	<b>999</b>	1044	1285
	TK2436-MH-TLEG-CA	36	24	26	52	<b>999</b>	1044	1285
Please specify base finish as black or silver. MH model is 26" high overall and will fit below a worktop.								
<b>2" column legs with casters</b>	TK3042-COL-CA	42	30	29	72	<b>1060</b>	1105	1346
	TK3042-MH-COL-CA	42	30	26	72	<b>1060</b>	1105	1346
Please specify base finish as black or silver. MH model is 26" high overall and will fit below a worktop.								

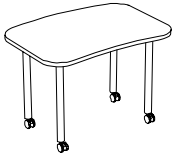

### Trapezoid Tables

<b>2" column leg</b>	TRAP2448-COL	48	24	29	68	<b>1008</b>	1055	1382
	TRAP3060-COL	60	30	29	91	<b>1215</b>	1262	1600
Please specify base finish as black or silver.								
<b>with caster</b>	TRAP2448-COL-CA	48	24	29	68	<b>1102</b>	1149	1476
	TRAP3060-COL-CA	60	30	29	91	<b>1308</b>	1355	1693
Please specify base finish as black or silver.								
<b>inverted 'T' legs</b>	TRAP2448-TLEG	48	24	29	62	<b>1008</b>	1055	1382
	TRAP3060-TLEG	60	30	29	85	<b>1215</b>	1262	1600
Please specify base finish as black or silver.								
<b>with casters</b>	TRAP2448-TLEG-CA	48	24	29	62	<b>1102</b>	1149	1476
	TRAP3060-TLEG-CA	60	30	29	85	<b>1308</b>	1355	1693
Please specify base finish as black or silver.								

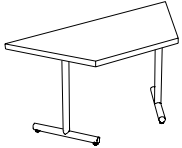
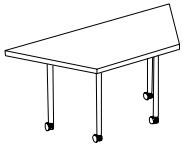
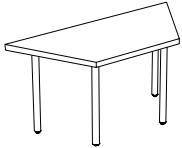

### Edge Options Information

Modular tables are available with the following edge options:

- WoodPlus 3 mm PVC edge Laminate Table Tops only
- Standard 3 mm Wood Edge
- Detailed 3/8" Wood Edge

	WoodPlus 3 mm PVC	Standard Wood	Detailed Wood
	Equations	Equations	
	WPES	SWES	RE
Modular 8	WPER	SWER	RA
	WPMS	SWMS	BE
	WPEN	SWEN	TR
	WPMN	SWMN	CL
	WPMR	SWMR	

## Modular Tables

### Square Tables

Description	Model Number	Dimensions			Wgt	List Prices		
		Wide	Deep	High		Wood Edges		
						WoodPlus	Standard	Detailed
<b>Radius cube</b>	TS4242-RC	42	42	29	61	<b>1199</b>	1270	1340
	TS4848-RC	48	48	29	80	<b>1250</b>	1321	1391

Please specify base finish as black or silver.

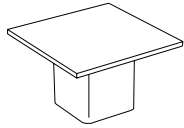

TS4848-RC



TS4848-COLX

<b>X on floor, center column</b>	TS3030-COLX	30	30	29	52	<b>783</b>	834	885
	TS3636-COLX	36	36	29	66	<b>832</b>	883	934
	TS4242-COLX	42	42	29	88	<b>921</b>	992	1062
	TS4848-COLX	48	48	29	110	<b>994</b>	1065	1135

Please specify base finish as black or silver.

### Rectangular Tables - 24" deep

<b>2" column leg</b>	TT2436-COL	36	24	29	58	<b>683</b>	730	1046
	TT2442-COL	42	24	29	63	<b>686</b>	733	1060
	TT2448-COL	48	24	29	68	<b>686</b>	733	1060
	TT2454-COL	54	24	29	73	<b>796</b>	843	1181
	TT2460-COL	60	24	29	78	<b>796</b>	843	1192

<b>with caster</b>	TT2436-COL-CA	36	24	29	58	<b>776</b>	823	1139
	TT2442-COL-CA	42	24	29	63	<b>780</b>	827	1154
	TT2448-COL-CA	48	24	29	68	<b>780</b>	827	1154
	TT2454-COL-CA	54	24	29	73	<b>889</b>	936	1274
	TT2460-COL-CA	60	24	29	78	<b>889</b>	936	1285

<b>inverted 'T' legs</b>	TT2436-TLEG	36	24	29	52	<b>683</b>	730	1046
	TT2442-TLEG	42	24	29	57	<b>686</b>	733	1060
	TT2448-TLEG	48	24	29	62	<b>686</b>	733	1060
	TT2454-TLEG	54	24	29	67	<b>796</b>	843	1181
	TT2460-TLEG	60	24	29	72	<b>796</b>	843	1192
	TT2472-TLEG	72	24	29	82	<b>874</b>	921	1270

<b>with casters</b>	TT2436-TLEG-CA	36	24	29	52	<b>776</b>	823	1139
	TT2442-TLEG-CA	42	24	29	57	<b>780</b>	827	1154
	TT2448-TLEG-CA	48	24	29	62	<b>780</b>	827	1154
	TT2454-TLEG-CA	54	24	29	67	<b>889</b>	936	1274
	TT2460-TLEG-CA	60	24	29	72	<b>889</b>	936	1285

Please specify base finish as black or silver.

#### Notes:

- Modular tables are shipped RTA (ready to assemble)

#### Options

Options are built-in at factory

Grommets

#### INLAY

-available ONLY with Detailed edge

INP Black 3mm (1/8") Inlay:  
Modular Rectangular tops  
Modular Shaped tops

INB Brushed Brass 3mm Inlay or  
INC Satin Chrome 3mm Inlay:  
Modular Rectangular tops  
Modular Shaped tops

#### Accessories

Order separately

TC Table Connectors are available for Modular Tables.

See end of this section for pricing and details.

## Modular Tables

### Rectangular Tables - 30" deep

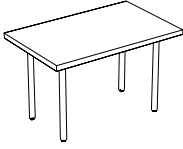
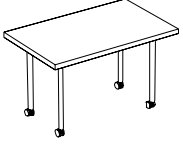
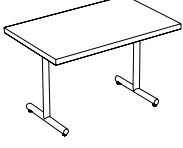
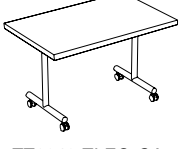
Description	Model Number	Dimensions			Wgt	List Prices		
		Wide	Deep	High		WoodPlus	Standard	Detailed
 TT3048-COL	2" column leg TT3036-COL	36	30	29	66	<b>769</b>	816	1132
	TT3042-COL	42	30	29	72	<b>797</b>	844	1171
	TT3048-COL	48	30	29	78	<b>816</b>	863	1190
	TT3054-COL	54	30	29	84	<b>839</b>	886	1224
	TT3060-COL	60	30	29	91	<b>861</b>	908	1246
 TT3048-COL-CA	with caster TT3036-COL-CA	36	30	29	66	<b>862</b>	909	1225
	TT3042-COL-CA	42	30	29	72	<b>890</b>	937	1264
	TT3048-COL-CA	48	30	29	78	<b>909</b>	956	1283
	TT3054-COL-CA	54	30	29	84	<b>932</b>	979	1317
	TT3060-COL-CA	60	30	29	91	<b>955</b>	1002	1340
 TT3048-TLEG	inverted 'T' legs TT3036-TLEG	36	30	29	60	<b>769</b>	816	1132
	TT3042-TLEG	42	30	29	66	<b>797</b>	844	1171
	TT3048-TLEG	48	30	29	72	<b>816</b>	863	1190
	TT3054-TLEG	54	30	29	78	<b>839</b>	886	1224
	TT3060-TLEG	60	30	29	85	<b>861</b>	908	1246
	TT3072-TLEG	72	30	29	97	<b>930</b>	977	1326
 TT3048-TLEG-CA	with casters TT3036-TLEG-CA	36	30	29	60	<b>862</b>	909	1225
	TT3042-TLEG-CA	42	30	29	66	<b>890</b>	937	1264
	TT3048-TLEG-CA	48	30	29	72	<b>909</b>	956	1283
	TT3054-TLEG-CA	54	30	29	78	<b>932</b>	979	1317
	TT3060-TLEG-CA	60	30	29	85	<b>955</b>	1002	1340

Please specify base finish as black or silver.

### Rectangular Tables - 36" deep

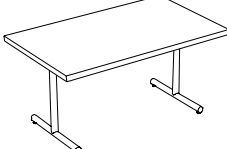
 TT3660-TLEG	inverted 'T' legs TT3642-TLEG	42	36	29	77	<b>887</b>	934	1261
	TT3648-TLEG	48	36	29	84	<b>926</b>	973	1300
	TT3660-TLEG	60	36	29	99	<b>943</b>	990	1328
	TT3672-TLEG	72	36	29	114	<b>984</b>	1031	1380

Please specify base finish as black or silver.

#### Edge Options Information

Modular tables are available with the following edge options:

- WoodPlus 3 mm PVC edge Laminate Table Tops only
- Standard 3 mm Wood Edge
- Detailed 3/8" Wood Edge

	WoodPlus 3 mm PVC	Standard Wood	Detailed Wood
	Equations WPES	Equations SWES	RE
Modular 8	WPER	SWER	RA
	WPMS WPEN	SWMS SWEN	BE
	WPMN	SWMN	TR
	WPMR	SWMR	CL

## Modular Tables

### Rectangular Tables - 42" deep

Description	Model Number	Dimensions			Wgt	List Prices		
		Wide	Deep	High		Wood Edges		
					WoodPlus	Standard	Detailed	
double column	TT4248-TLEG2	48	42	29	116	<b>1050</b>	1097	1424
inverted ' T' leg	TT4260-TLEG2	60	42	29	134	<b>1088</b>	1135	1473
	TT4272-TLEG2	72	42	29	151	<b>1137</b>	1184	1533

Please specify base finish as black or silver.

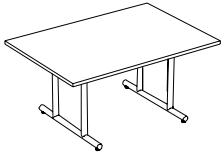

TT4260-TLEG2

### Rectangular Tables - 48" deep

double column	TT4860-TLEG2	60	48	29	146	<b>1184</b>	1348	1516
inverted ' T' leg	TT4872-TLEG2	72	48	29	166	<b>1238</b>	1402	1570

Please specify base finish as black or silver.

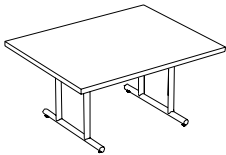

TT4860-TLEG2

### Training Tables with C-Leg Base

Oval C leg, 24" deep	TT2448-CLEG-WM	48	24	29	62	<b>1053</b>	1100	1427
	TT2460-CLEG-WM	60	24	29	72	<b>1207</b>	1254	1603
	TT2472-CLEG-WM	72	24	29	82	<b>1284</b>	1331	1680

Includes black metal modesty panel with built in wiremanager.  
Base finish is Black powder coat.

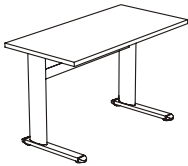

with casters	TT2448-CLEG-WM-CA	48	24	29	62	<b>1131</b>	1178	1505
	TT2460-CLEG-WM-CA	60	24	29	72	<b>1284</b>	1331	1680
	TT2472-CLEG-WM-CA	72	24	29	62	<b>1361</b>	1408	1757

Includes black metal modesty panel with built in wiremanager.  
Base finish is Black powder coat.

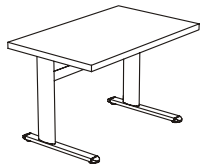

Oval C leg, 30" deep	TT3048-CLEG-WM	48	30	29	72	<b>1228</b>	1275	1602
	TT3060-CLEG-WM	60	30	29	85	<b>1225</b>	1272	1621
	TT3072-CLEG-WM	72	30	29	97	<b>1308</b>	1355	1704

Includes black metal modesty panel with built in wiremanager.  
Base finish is Black powder coat.

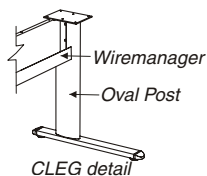

with casters	TT3048-CLEG-WM-CA	48	30	29	72	<b>1305</b>	1352	1679
	TT3060-CLEG-WM-CA	60	30	29	85	<b>1303</b>	1350	1699
	TT3072-CLEG-WM-CA	72	30	29	97	<b>1384</b>	1431	1780

Includes black metal modesty panel with built in wiremanager.  
Base finish is Black powder coat.

Option	WoodPlus modesty panel is available with MJT	<b>151</b>	151	151
--------	--	------------	-----	-----

#### Notes:

- Modular tables are shipped RTA (ready to assemble)

#### Options

Options are built-in at factory

Grommets

#### INLAY

-available ONLY with Detailed edge

INP Black 3mm (1/8") Inlay:  
Modular Rectangular tops  
Modular Shaped tops

INB Brushed Brass 3mm Inlay or  
INC Satin Chrome 3mm Inlay:  
Modular Rectangular tops  
Modular Shaped tops

#### Accessories

Order separately

TC Table Connectors are available for Modular Tables.

See end of this section for pricing and details.

## Modular Table

### Mobile Utility Table

Description	Model Number	Dimensions			Wgt	List Prices		
		Wide	Deep	High		Wood Edges		
					WoodPlus	Standard	Detailed	
with Casters	MUT-2419-CA	19	24	0	35	907	956	1141

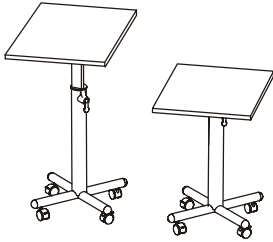

### Slide table, casters available

Description	Model Number	Dimensions			Wgt	WP	WP2
		Wide	Deep	High		1688	1601
with levelers	SLIDE-3260-EC0	32	60	29	85	1688	1601



with one set of casters	SLIDE-3260-EC2 Casters are locking.	32	60	29	85	1764	1677
-------------------------	--	----	----	----	----	------	------



with two sets of casters	SLIDE-3260-EC4 Casters are locking.	32	60	29	85	1841	1746
--------------------------	--	----	----	----	----	------	------



Table - flip top, casters, single release handle	SLIDE-FLIP-3260-ARCHT-CA Casters are locking.	32	60	29	85	2090	2047
--	--	----	----	----	----	------	------

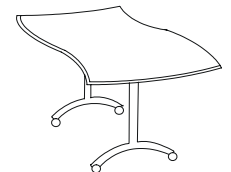

Slide tables may be self-locked together and easily re-configured

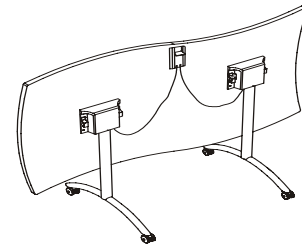
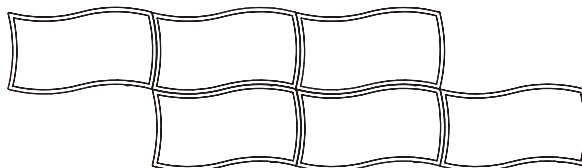
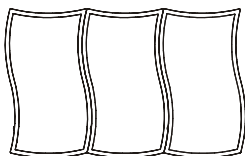
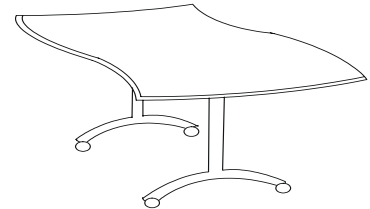
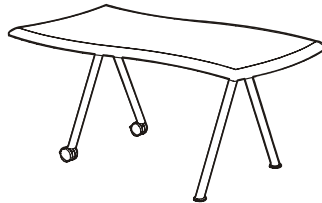
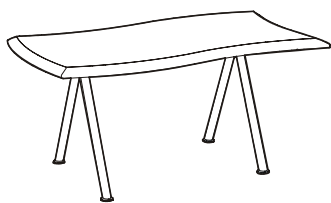



## Modular Tables

### Grommet Options

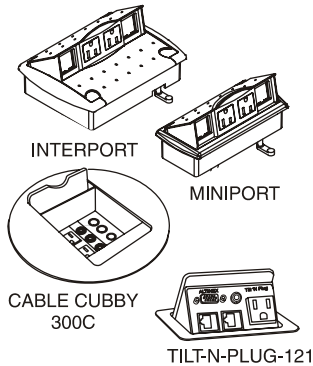

Description	Model Number	Dimensions			Wgt	List Price
		Wide	Deep	High		
<b>Recessed electrical, data access</b>	MINIPLUG-120	7	3	2	2	197
	MINIPLUG-STARTER-72	7	3	2	2	440
	MINIPLUG-ADDER-48	7	3	2	2	246
	MINIPLUG-ADDER-72	7	3	2	2	246
	MINIPLUG-ADDER-120	7	3	2	2	246
	INTERPORT-PLUG-120	7	5	2	2	236
	INTERPORT-STARTER-72	7	5	2	2	470
	INTERPORT-ADDER-48	7	5	2	2	262
	INTERPORT-ADDER-72	7	5	2	2	262
	INTERPORT-ADDER-120	7	5	2	2	262
	CABLE-CUBBY-300C	6	6	1	2	1322
	TILT-N-PLUG-121	5	5	0	1	1322
TILT-N-PLUG-121-UL	5	5	0	1	1502	

MINIPLUG-PLUG and INTERPORT-PLUG both house two electrical outlets with 6' cord and two data locations. The receptacle plates for most connectors are included. Electrical outlets with plug ends.

MINIPLUG and INTERPORT may be setup 'daisy-chained' and hardwired to the building power supply, please contact Customer Service with your requirements.

CABLE-CUBBY-300C has a round faceplate and houses two AC outlets, one video and two audio jacks, up to three sizes of pass through cable openings (using AAP Architectural Adapter Plates). Electrical outlets with plug ends.

TILT-N-PLUG-121 houses single input plate with Computer Video (15-pin HD), Computer Audio (Stereo Mini), Modem (RJ11), and Network (RJ45) input connections. One electrical outlet with plug end. **Data connectors are NOT included.**

TILT-N-PLUG-121-UL is a UL labeled product with the same configuration as the TILT-N-PLUG-121

### Modular Table Connectors

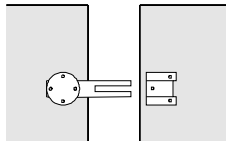

Top Connector

Top Connectors	Model Number	Wgt	List Price
TC-THR		4	40
TC-TQR		2	40
TC-TRAP		4	40
TC-TS		6	60
TC-TT		6	79

To order add -TC to the end of the model number, e.g. TT-2448-Col-TC.

NOTE: TC connectors are for use with small Modular Tables; NOT for use with ACT or Conference tables.

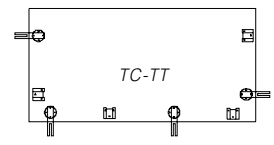
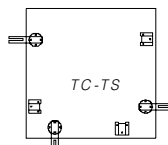
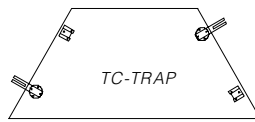
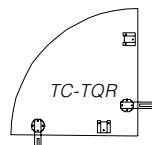
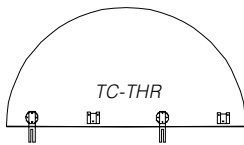

### Radius Corners added to a Table top

Description	Model Number	Dimensions			Wgt	List Price
		Wide	Deep	High		
<b>Add Radius Corners</b>	Top-C3R-WPE					412
	Top-C3R-STD					412
	Top-C3R-DET					594

3 radius on the inside of the edge. To order add ' -C3R' to the end of the table model number. Rectangular top with Radius corners uses the the Shaped top INLAY upcharge.

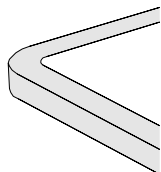



# Modular Table Assemblies

## Overview - Modular Table Assemblies

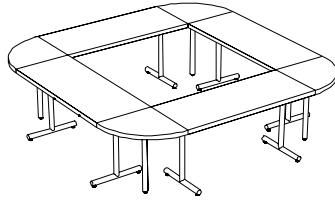

Assembly Sizes include:  
9' x 9', 9' x 14', 10' x 10' and 10' x 15'

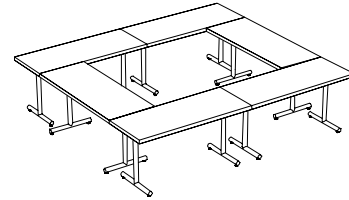

Assembly sizes include:  
9' x 10', 14' x 10', 10' x 10' and 10' x 15'

Round Corner 'O' shape - Modular Table Assembly, see Pg 112

Square Corner 'O' shape - Modular Table Assembly, see Pg 112

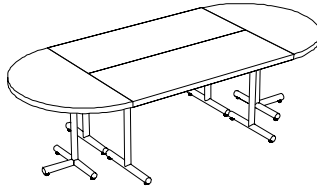

Assembly sizes include:  
4' x 9', 4' x 14', 5' x 10' and 5' x 15'

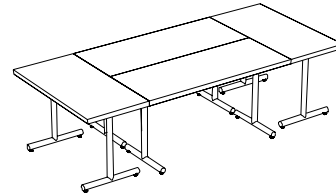

Assembly sizes include:  
4' x 9', 4' x 14', 5' x 10' and 5' x 15'

Racetrack shape - Modular Table Assembly, see Pg 113

Rectangular shape - Modular Table Assembly, see Pg 113

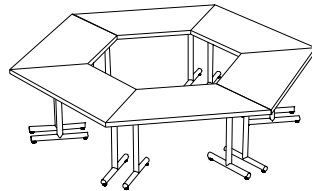

Assembly sizes include:  
7' x 8' and 9' x 10'

Trapezoid Hexagonal shape - Modular Table Assembly, see Pg 113

## Modular Table Assemblies

### Round Corner 'O' shape - Modular Table Assembly

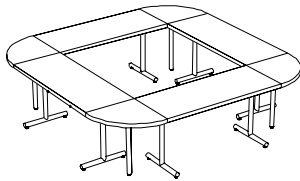

TMOR-909-TLEG

Description	Model Number	Dimensions			Wgt	List Prices		
		Wide	Deep	High		Wood Edges		
						WoodPlus	Standard	Detailed
<b>24" deep tops</b>	TMOR-909-TLEG	108	108	29	428	<b>6052</b>	6420	8780
	TMOR-914-TLEG	108	168	29	584	<b>7802</b>	8264	11322
<b>with casters</b>	TMOR-909-TLEG-CA	108	108	29	428	<b>6520</b>	6888	9248
	TMOR-914-TLEG-CA	108	168	29	584	<b>8456</b>	8918	11976
<b>30" deep tops</b>	TMOR-1010-TLEG	120	120	29	524	<b>7016</b>	7384	9700
	TMOR-1015-TLEG	120	180	29	706	<b>8896</b>	9358	12350
<b>with casters</b>	TMOR-1010-TLEG-CA	120	120	29	524	<b>7484</b>	7852	10168
	TMOR-1015-TLEG-CA	120	180	29	706	<b>9552</b>	10014	13006

### Square Corner 'O' shape - Modular Table Assembly

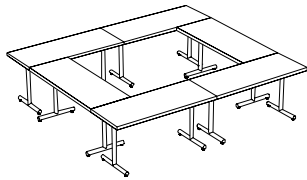

TMOS-910-TLEG

<b>24" deep tops</b>	TMOS-910-TLEG	108	120	29	468	<b>5250</b>	5532	7626
	TMOS-1410-TLEG	168	120	29	624	<b>7000</b>	7376	10168
<b>with casters</b>	TMOS-910-TLEG-CA	108	120	29	468	<b>5808</b>	6090	8184
	TMOS-1410-TLEG-CA	168	120	29	624	<b>7744</b>	8120	10912
<b>30" deep tops</b>	TMOS-1010-TLEG	120	120	29	546	<b>5640</b>	5922	7950
	TMOS-1015-TLEG	120	180	29	728	<b>7520</b>	7896	10600
<b>with casters</b>	TMOS-1010-TLEG-CA	120	120	29	546	<b>6204</b>	6486	8514
	TMOS-1015-TLEG-CA	120	180	29	728	<b>8272</b>	8648	11352

#### Edge Options Information

Modular tables are available with the following edge options:

- WoodPlus 3 mm PVC edge
- Standard 3 mm Wood Edge
- Detailed 3/8" Wood Edge

	WoodPlus 3 mm PVC	Standard Wood	Detailed Wood
Equations	WPES	SWES	RE
Modular 8	WPER	SWER	RA
	WPMS	SWMS	BE
	WPEN	SWEN	TR
	WPMN	SWMN	
	WPMR	SWMR	CL

## Modular Table Assemblies

### Racetrack shape - Modular Table Assembly



Description	Model Number	Dimensions			Wgt	List Prices		
		Wide	Deep	High		WoodPlus	Standard	Detailed
<b>24" deep tops</b>	TMR-409-TLEG	48	108	29	294	<b>3846</b>	4004	5070
	TMR-414-TLEG	48	168	29	450	<b>5596</b>	5848	7612
<b>with casters</b>	TMR-409-TLEG-CA	48	108	29	294	<b>4220</b>	4378	5444
	TMR-414-TLEG-CA	48	168	29	450	<b>6156</b>	6408	8172
<b>30" deep tops</b>	TMR-510-TLEG	60	120	29	366	<b>4390</b>	4606	5916
	TMR-515-TLEG	60	180	29	548	<b>6270</b>	6580	8566
<b>with casters</b>	TMR-510-TLEG-CA	60	120	29	366	<b>4764</b>	4980	6290
	TMR-515-TLEG-CA	60	180	29	548	<b>6832</b>	7142	9128

### Rectangular shape - Modular Table Assembly

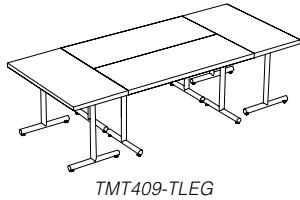

<b>24" deep tops</b>	TMT-409-TLEG	48	108	29	312	<b>3500</b>	3688	5084
	TMT-414-TLEG	48	168	29	468	<b>5250</b>	5532	7626
<b>with casters</b>	TMT-409-TLEG-CA	48	108	29	312	<b>3872</b>	4060	5456
	TMT-414-TLEG-CA	48	168	29	468	<b>5808</b>	6090	8184
<b>30" deep tops</b>	TMT-510-TLEG	60	120	29	364	<b>3760</b>	3948	5300
	TMT-515-TLEG	60	180	29	546	<b>5640</b>	5922	7950
<b>with casters</b>	TMT-510-TLEG-CA	60	120	29	364	<b>4136</b>	4324	5676
	TMT-515-TLEG-CA	60	180	29	546	<b>6204</b>	6486	8514

### Trapezoid Hexagonal shape - Modular Table Assembly

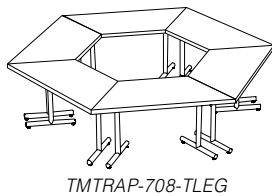

<b>24" deep tops</b>	TMTRAP-708-TLEG	84	96	29	396	<b>6288</b>	6570	8532
<b>with casters</b>	TMTRAP-708-TLEG-CA	84	96	29	396	<b>6852</b>	7134	9096
<b>30" deep tops</b>	TMTRAP-910-TLEG	108	120	29	534	<b>7530</b>	7812	9840
<b>with casters</b>	TMTRAP-910-TLEG-CA	108	120	29	534	<b>8088</b>	8370	10398

#### Notes:

- Modular tables are shipped RTA (ready to assemble)

#### Options

Options are built-in at factory

Single and Double Grommets . . . . . see page at end of this section

INLAY -available ONLY with Detailed or Larger edge.

See Modular Table Assembly Options for Inlay pricing per assembly.

#### Accessories

Order separately

TC Table Connectors are included with Modular Table Assemblies.

# Modular Table Assemblies

## Modular Table Assembly Options

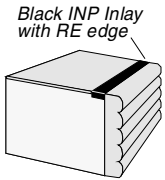
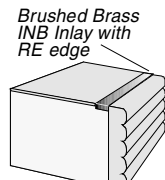
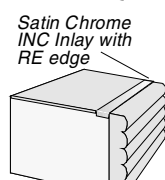
Description	Model Number	Dimensions			Wgt	List Price
		Wide	Deep	High		
 Black INP Inlay with RE edge	<b>Black Inlay</b> INLAY-TMOR-BLACK					2923
	INLAY-TMOS-BLACK					2273
	INLAY-TMR-BLACK					1624
	INLAY-TMT-BLACK					1624
	INLAY-TMTRAP-BLACK					1949
 Brushed Brass INB Inlay with RE edge	<b>Brushed Brass Inlay</b> INLAY-TMOR-BRASS					5848
	INLAY-TMOS-BRASS					4548
	INLAY-TMR-BRASS					3248
	INLAY-TMT-BRASS					3248
	INLAY-TMTRAP-BRASS					3898
 Satin Chrome INC Inlay with RE edge	<b>Satin Chrome Inlay</b> INLAY-TMOR-CHROME					5848
	INLAY-TMOS-CHROME					4548
	INLAY-TMR-CHROME					3248
	INLAY-TMT-CHROME					3248
	INLAY-TMTRAP-CHROME					3898
<b>Grommets</b>	GR	4.25	2.75			<b>48</b>
	GR = Grommet with cover. Opening: 2 x 3.5 Specify location of grommets, see following page.					
<b>Inserts for above grommets</b>	DVR-INSERT	4.25	2.75	5	1	<b>66</b>
	PDC-INSERT	4.25	2.75	5	1	<b>138</b>
	WHT-INSERT	4.25	2.75	5	1	<b>148</b>
	<b>WHT</b> = Work Height Triplex. 6' cord. WHT pull up size: 2 x 3.5 x 5-1/8 high when extended. <b>DVR</b> = Data / Voice Receptacle. DVR pull up size: 2 x 3.5 x 5-1/8 high when extended. DVR is a work surface Pop-up that accepts various receptacle plates to be supplied by your electrical contractor or installer. <b>DVR does NOT INCLUDE any receptacles or receptacle plates.</b> <b>PDC</b> = Power / Data Combination. PDC pull up size: 2 x 3.5 x 5-1/8 high when extended. PDC is a work surface pop-up that accepts a combination of Power, Data and Voice (telephone) outlets (up to 2 each). <b>PDC does NOT INCLUDE any receptacles or receptacle plates.</b>					
<b>Recessed electrical, data access</b>	MINIPLUG-PLUG-120	7	3	2	2	<b>197</b>
	MINIPLUG-STARTER-72	7	3	2	2	<b>440</b>
	MINIPLUG-ADDER-48	7	3	2	2	<b>246</b>
	MINIPLUG-ADDER-72	7	3	2	2	<b>246</b>
	MINIPLUG-ADDER-120	7	3	2	2	<b>246</b>
	INTERPLUG-PLUG-120	7	5	2	2	<b>236</b>
	INTERPLUG-STARTER-72	7	5	2	2	<b>470</b>
	INTERPLUG-ADDER-48	7	5	2	2	<b>262</b>
	INTERPLUG-ADDER-72	7	5	2	2	<b>262</b>
	INTERPLUG-ADDER-120	7	5	2	2	<b>262</b>
	CABLE-CUBBY-300C	6	6	0	1	<b>1322</b>
	TILT-N-PLUG-121	5	5	0	1	<b>1322</b>
	TILT-N-PLUG-121-UL	5	5	0	1	<b>1502</b>

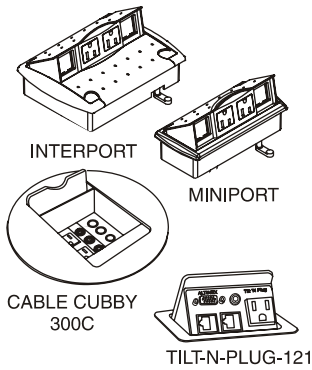

**MINIPLUG-PLUG and INTERPLUG-PLUG** both house two electrical outlets with 6' cord and two data locations. The receptacle plates for most connectors are included. Electrical outlets with plug ends.

**MINIPLUG and INTERPLUG may be setup 'daisy-chained'** and hardwired to the building power supply, please contact Customer Service with your requirements.

**CABLE-CUBBY-300C** has a round faceplate and houses two AC outlets, one video and two audio jacks, up to three sizes of pass through cable openings (using AAP Architectural Adapter Plates). Electrical outlets with plug ends.

**TILT-N-PLUG-121** houses single input plate with Computer Video (15-pin HD), Computer Audio (Stereo Mini), Modem (RJ11), and Network (RJ45) input connections. One electrical outlet with plug end.

**TILT-N-PLUG-121-UL** is a UL labeled product with the same configuration as the TILT-N-PLUG-121.

# Presentation Units

## Overview - Presentation Units

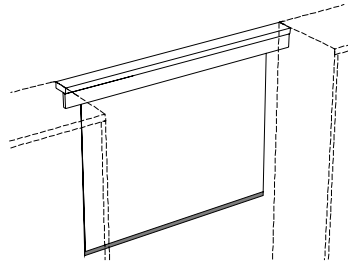

Projection Valance and Projection Screen, see Pg 115

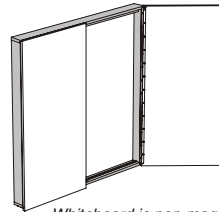

Whiteboard is non-magnetic  
Door finish is the same on the both faces

Presentation Display Boards - Non-magnetic, see Pg 116

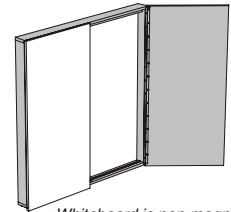

Whiteboard is non-magnetic  
Inside of door is black and matches the case finish

Presentation Display Boards - Non-magnetic - WoodPlus2, see Pg 117

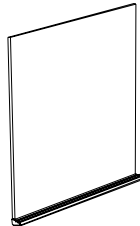

Marker Boards, see Pg 118

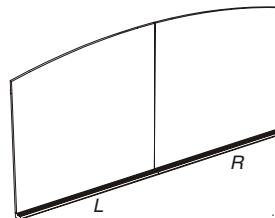

Marker Boards, see Pg 118

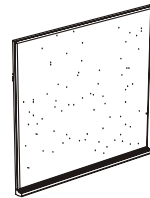

Marker Boards, see Pg 118

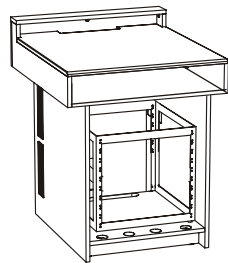

Multimedia lecterns with flat tops, see Pg 120

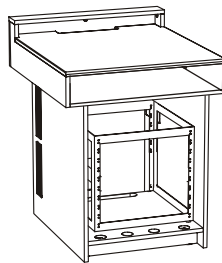

Multimedia lecterns with flat tops, see Pg 120

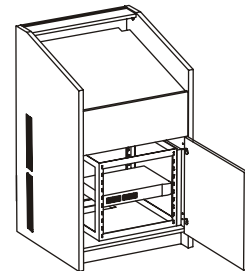

Multimedia lecterns with sloped tops, see Pg 122

## Projection Valance and Projection Screen

Description	Model Number	Dimensions			Wgt	List Prices		
		Wide	Deep	High		Wood Edges		
						WoodPlus	Standard	Detailed
<b>Valance</b>	PSV-60	60	5	6	30	<b>545</b>	594	792
	PSV-72	72	5	6	36	<b>593</b>	642	840
<b>with Projection Screen</b>	PSV-60-PS	60	5	6	53	<b>879</b>	928	1126
	PSV-72-PS	72	5	6	61	<b>927</b>	976	1174

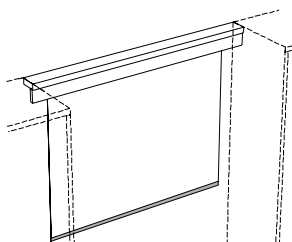

PSV-72-PS

On the PSV-60-PS, the projection screen is 42" wide and 50" tall  
On the PSV-72-PS, the projection screen is 60" wide and 50" tall.

## Presentation Units

### Presentation Display Boards - Non-magnetic

Description	Model Number	Dimensions			Wgt	List Price WPE edge
		Wide	Deep	High		
<b>WoodPlus Edge</b>	PDB-4848-WPE	48	4	48	140	<b>1188</b>
<b>Doors</b>	PDB-4872-WPE	72	4	48	175	<b>1614</b>
	STD WOOD EDGE	optional 3mm hardwood edge on PDB doors, add				<b>186</b>

Case is standard in Black laminate; doors are WoodPlus with Woodplus edge.  
Includes non-magnetic whiteboard and a Dry Erase marker and eraser.  
Wall mount bracket included.

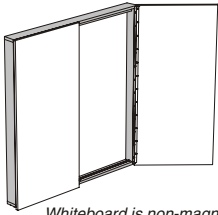

Whiteboard is non-magnetic  
Door finish is the same  
on the both faces

### Presentation Display Boards - Magnetic

<b>WoodPlus Edge</b>	PDBM-4848-WPE	48	4	48	140	<b>1339</b>
<b>Doors</b>	PDBM-4872-WPE	72	4	48	175	<b>1836</b>
	STD WOOD EDGE	optional 3mm hardwood edge on PDB doors, add				<b>186</b>

Case is standard in Black laminate; doors are WoodPlus with Woodplus edge.  
Includes magnetic whiteboard and a Dry Erase marker and eraser.  
Wall mount bracket included.

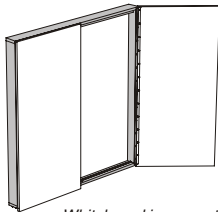

Whiteboard is magnetic  
Door finish is the same  
on the both faces

### Presentation Display Board Accessories

<b>Projection</b>	PDB-PROJECTION-SCREEN-42	42	50	18	<b>251</b>
<b>Screen</b>	PDB-PROJECTION-SCREEN-60	60	50	24	<b>251</b>

Projection Screen includes Valance to match case.

PDB-PROJECTION-SCREEN-42 is 42" wide and 50" high, use on 48" wide PDB or PDMB.

PDB-PROJECTION-SCREEN-60 is 60" wide and 50" high, use on 72" wide PDB or PDMB.

<b>Laminate Trim Kit</b>	PDB-TRIM-KIT				<b>58</b>
--------------------------	--------------	--	--	--	-----------

Trim kit includes two side pieces that match doors.

<b>Door fabric panels</b>	PD-FP-1	fabric tackboard for one door			<b>156</b>
	PD-FP-2	fabric tackboard for both doors			<b>245</b>

Pricing shown is for Magna Design fabric grades A, B, or C

<b>Flip charts</b>	FLIP-CHART-1	Flip chart mounted on one door			<b>46</b>
--------------------	--------------	--------------------------------	--	--	-----------

<b>Marker board for doors</b>	PDB-MB-DOOR-PANEL-1				<b>147</b>
	PDB-MB-DOOR-PANEL-2				<b>245</b>

### Option for Presentation Display Boards

<b>Door Locks</b>	PDB-Door-Lock				<b>87</b>
-------------------	---------------	--	--	--	-----------

#### Edge Options Information

Presentation Units are available with the following edge options:

- WoodPlus 3 mm PVC edge on sides and top
- MB bottom wood rail is finished to match the WoodPlus edge finish on the sides and top.

#### Marker Board Edge finishes:

WP-04 Solar Oak  
WP-23Cordovan  
WP-31Medium Cherry  
WP-33Blossom Cherry  
WP-41Natural Maple  
WP-45Anigre (color match only)  
WP-61Pear  
WP-71Dark Cherry  
WP-73Cognac  
WP-75Chestnut  
WP-81Fusion Maple (color match only)  
CP-76Espresso  
CP-88Black  
CP-98Slate

WoodPlus  
Edge



## Presentation Units

### Presentation Display Boards - Non-magnetic - WoodPlus2

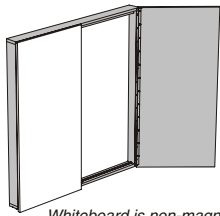

Whiteboard is non-magnetic  
Inside of door is black and  
matches the case finish

Description	Model Number	Dimensions			Wgt	List Price WPE edge
		Wide	Deep	High		
	PDB-TECH-4846-WP2	46	4	48	140	<b>1665</b>

<b>Projection Screen</b>	PDB-PROJECTION-SCREEN-42	42		50	18	<b>251</b>
	Projection Screen and Valance accessory for PDB.					
<b>Trim Kit</b>	PDB-TRIM KIT	Matches door finish				<b>58</b>
	Trim kit includes two side pieces that match doors.					
<b>Fabric panel</b>	PD-FP-1	fabric tackboard for one door				<b>156</b>
	PD-FP-2	fabric tackboard for both doors				<b>245</b>
	Pricing shown is for Magna Design fabric grades A, B, or C					
<b>Flip Chart</b>	FLIP-CHART-1	Flip chart mounted on one door				<b>46</b>

### Mobile White Board

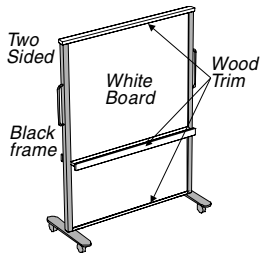

MWB-4260

<b>Mobile White Board</b>	MWB-3660	36	4	60	120	<b>1707</b>
	MWB-4260	42	4	60	134	<b>1889</b>

Specify wood trim (top cap and tray) finish, choose from any table top wood edge finish.  
Frame finish is Black.  
White board is NON magnetic.

### Display Rails, Wall Mounted

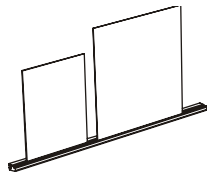

Display Rail profile

<b>Wall Mounted</b>	DRW-48	48	3	2	5	<b>527</b>
	DRW-60	60	3	2	7	<b>563</b>
	DRW-72	72	3	2	9	<b>599</b>

Specify wood finish, choose from any table top wood edge finish.

### Notes:

Presentation Units are shipped assembled.

## Presentation Units

### Marker Boards

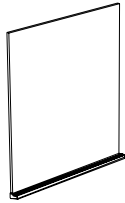

MB-4848

Description	Model Number	Dimensions			Wgt	List Price WPE edge
		Wide	Deep	High		
<b>WoodPlus PVC Edge,</b>	MB-2436-WPE	36	1.75	24	30	<b>569</b>
	MB-3636-WPE	36	1.75	36	45	<b>659</b>
<b>Hardwood rail</b>	MB-4242-WPE	42	1.75	42	74	<b>662</b>
	MB-4248-WPE	48	1.75	42	77	<b>673</b>
	MB-4848-WPE	48	1.75	48	80	<b>673</b>
	MB-4860-WPE	60	1.75	48	100	<b>732</b>
	MB-4872-WPE	72	1.75	48	120	<b>833</b>
	MB-4896-WPE	96	1.75	48	160	<b>904</b>
STD WOOD EDGE	optional 3mm hardwood edge on PDB doors, add					<b>186</b>

Non-magnetic white Marker Board; includes Marker pen and eraser.

Specify edge finish for the lower pen holder and edge trim on top and sides.

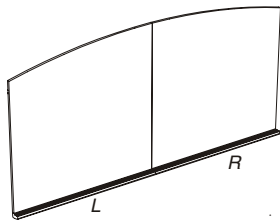

MB-ARCH-4848-L-WPE  
MB-ARCH-4848-R-WPE

<b>Archiving White Board,</b>	MB-ARCH-4848-L-WPE	48	1.75	48	66	<b>784</b>
	MB-ARCH-4848-R-WPE	48	1.75	48	66	<b>784</b>
<b>Woodplus edges,</b>	MB-ARCH-4860-L-WPE	60	1.75	48	80	<b>843</b>
	MB-ARCH-4860-R-WPE	60	1.75	48	80	<b>843</b>
<b>Hardwood rail</b>	MB-ARCH-4872-L-WPE	72	1.75	48	96	<b>944</b>
	MB-ARCH-4872-R-WPE	72	1.75	48	96	<b>944</b>
STD WOOD EDGE	optional 3mm hardwood edge on PDB doors, add					<b>186</b>

Non-magnetic White Board, Arched Top, has hardwood rail to hold markers and eraser Marker pen and eraser included.

For 'full' arch please order one Left and one Right.

Specify edge finish for the lower pen holder and edge trim on top and sides..

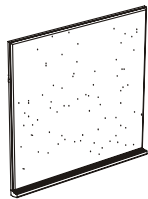

MB-FP-4848-WPE

<b>Tackboards,</b>	MB-FP-4242-WPE	42	1.75	42	63	<b>747</b>
<b>WoodPlus edge,</b>	MB-FP-4248-WPE	48	1.75	42	66	<b>747</b>
<b>Hardwood rail</b>	MB-FP-4848-WPE	48	1.75	48	66	<b>747</b>
	MB-FP-4860-WPE	60	1.75	48	80	<b>802</b>
	MB-FP-4872-WPE	72	1.75	48	96	<b>907</b>
STD WOOD EDGE	optional 3mm hardwood edge on PDB doors, add					<b>186</b>

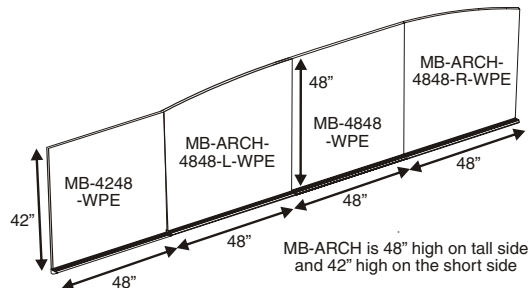

#### Edge Options Information

Presentation Units are available with the following edge options:

- WoodPlus 3 mm PVC edge on sides and top
- MB bottom wood rail is finished to match the WoodPlus edge finish on the sides and top.

#### Marker Board Edge finishes:

WP-04 Solar Oak  
WP-23Cordovan  
WP-31Medium Cherry  
WP-33Blossom Cherry  
WP-41Natural Maple  
WP-45Anigre (color match only)  
WP-61Pear  
WP-71Dark Cherry  
WP-73Cognac  
WP-75Chestnut  
WP-81Fusion Maple (color match only)  
CP-76Espresso  
CP-88Black  
CP-98Slate



WoodPlus  
Edge



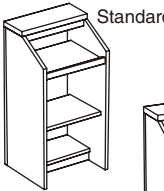
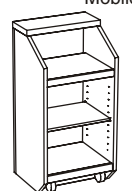

# Lecterns

## Lecterns

Description	Model Number	Dimensions			Wgt	List Prices			
		Wide	Deep	High		WoodPlus	Standard	Detailed	
 Standard  Mobile  Table top	<b>Standard Lectern</b>	CRL-STANDARD	24	21	48	120	<b>1805</b>	1852	2059
	Lecterns include a cord gap to allow optional Light or Electrical Strip cords to reach the floor.								
<b>Mobile Lectern</b>	CRL-MOBILE	24	21	48	126	<b>1997</b>	2044	2251	
<b>Table Top Lectern</b>	CRL-TABLE-TOP	24	21	18	44	<b>983</b>	1030	1237	

## Lecterns - options and accessories

<b>Grommets</b>	GR	4.25	2.75		48	<b>48</b>	48	48
GR = Grommet with cover. Opening: 1-3/4" x 3-1/2". Specify location: Left or Right.								
<b>Inserts for grommets</b>	DVR-INSERT	4.25	2.75	5		<b>66</b>	66	66
	PDC-INSERT	4.25	2.75	5		<b>138</b>	138	138
	WHT-INSERT	4.25	2.75	5		<b>148</b>	148	148

**WHT** = Work Height Triplex. 6' cord with plug.

**WHT** pull up size: 2 x 3.5 x 5-1/8" high when extended.

**DVR** = Data / Voice Receptacle.

**DVR** pull up size: 2 x 3.5 x 5-1/8" high when extended. **DVR** is a work surface Pop-up that accepts various receptacle plates to be supplied by your electrical contractor or installer. **DVR does NOT INCLUDE any receptacles or receptacle plates.**

**PDC** = Power / Data Combination.

**PDC** pull up size: 2 x 3.5 x 5-1/8" high when extended. **PDC** is a work surface pop-up that accepts a combination of Power, Data and Voice (telephone) outlets (up to 2 each). **PDC does NOT INCLUDE any receptacles or receptacle plates.**

<b>Power Strip</b>	CRL-DATA-ELECTRICAL				3	<b>125</b>	125	125
Includes 6 grounded outlets, on/off switch and 6' cord with plug.								

<b>CRL Light</b>	CRL-LIGHT	9	2	1	3	<b>256</b>	256	256
Specially sized Halogen Light includes 6' cord with plug.								

## Edge Options Information

Lecterns are available with the following edge options:

- WoodPlus 3 mm PVC edge
- . . . Standard 3 mm Wood Edge
- Detailed 3/8" Wood Edge

### Notes:

Lecterns include a cord gap to allow optional Light or Electrical Strip cords to reach the floor.

WoodPlus 3 mm PVC	Standard Wood	Detailed Wood
Equations WPES	Equations SWES	RE
Modular 8 WPER	Modular 8 SWER	RA
WPMS	SWMS	BE
WPMN	SWMN	TR
WPMR	SWMR	CL

# Multimedia Lecterns

## Multimedia lecterns with flat tops

Description	Model Number	Dimensions			Wgt	List Price
		Wide	Deep	High		
<b>Adjustable shelf</b>	CRL-MF-2830-38-SHELF	30	28	38	176	<b>1866</b>
	CRL-MF-3430-38-SHELF	30	34	38	188	<b>1866</b>

Includes adjustable shelf and finished panel on audience side

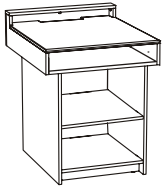

<b>Equipment Rack</b>	CRL-MF-2830-38-RACK	30	28	38	176	<b>2775</b>
	CRL-MF-3430-38-RACK	30	34	38	188	<b>2775</b>

Includes equipment rack, side and bottom vents and audience side door.

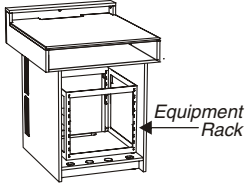

<b>Option:</b>	OPTION-DL	33	32		30	<b>704</b>
<b>Drop leaves</b>	OPTION-DLL	33	16		15	<b>352</b>
	OPTION-DLR	33	16		15	<b>352</b>

Add DL to model number for drop leaves on both sides, DLL for left side only, DLR for the right side only.

Shown on CRL-MF-3430-RACK model.

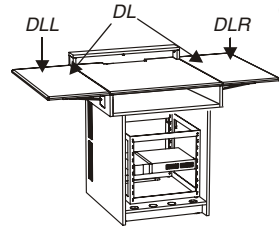

<b>Option:</b>	OPTION-UD				27	<b>254</b>
----------------	-----------	--	--	--	----	------------

**User side door** Add UD to model number for user side door with touch latch. Shown on CRL-MF-3430-SHELF model.

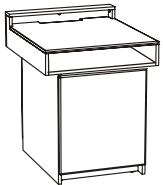

<b>Option:</b>	OPTION-MKT	12			15	<b>119</b>
----------------	------------	----	--	--	----	------------

**Pullout keyboard tray** Add MKT to model number for molded pullout keyboard tray. Shown on CRL-MF-3430-RACK model.

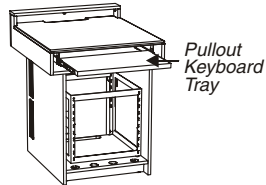

<b>Option:</b>	OPTION-LECTERN-MM-CA					<b>703</b>
----------------	----------------------	--	--	--	--	------------

<b>Casters,</b>	OPTION-VENTS					<b>175</b>
-----------------	--------------	--	--	--	--	------------

<b>Vents,</b>	OPTION-CUTOUTS					<b>117</b>
---------------	----------------	--	--	--	--	------------

**Cutouts** Add CA to model number for four 2-1/2" casters, two locking. Shown on CRL-MF-3430-RACK model.

Add VENTS to SHELF model number for side and bottom vents. Side and bottom vents are included with the RACK model.

Add CUTOUT to model number for cutouts for other options such as microphones, etc. and provide a template for the required cutout. Price is for cutout only, does not include equipment.

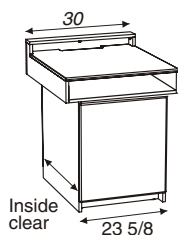
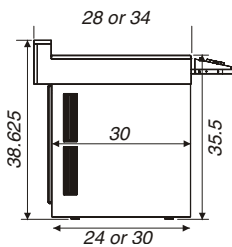

Inside Clear dimension

For 34" deep units the lower section has 30" clear on the inside front to back

For 28" deep units the lower section has 24" clear on the inside front to back

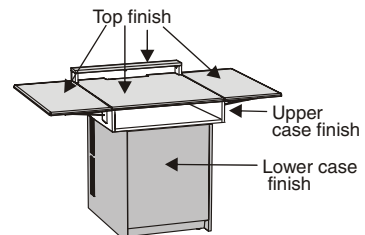

## Multimedia Lecterns

### WP2 Multimedia lecterns with flat tops

Description	Model Number	Dimensions			Wgt	List Price
		Wide	Deep	High		
<b>Adjustable shelf</b>	CRL-MF-2830-38-SHELF-WP2	30	28	38	176	<b>2140</b>
	CRL-MF-3430-38-SHELF-WP2	30	34	38	188	<b>2140</b>

Includes adjustable shelf and finished panel on audience side.

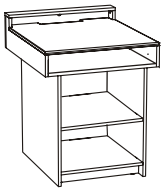

<b>Equipment Rack</b>	CRL-MF-2830-38-RACK-WP2	30	28	38	176	<b>3048</b>
<b>Rack</b>	CRL-MF-3430-38-RACK-WP2	30	34	38	188	<b>3048</b>

Includes equipment rack, side and bottom vents and audience side door.

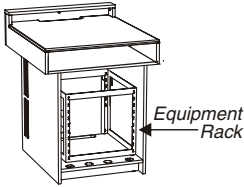

<b>Option:</b>	OPTION-DL-WP2	33	33		30	<b>704</b>
<b>Drop leaves</b>	OPTION-DLL-WP2	33	33		15	<b>352</b>
	OPTION-DLR-WP2	33	33		15	<b>352</b>

Add DL to model number for drop leaves on both sides, DLL for left side only, DLR for the right side only.

Shown on CRL-MF-3430-RACK model.

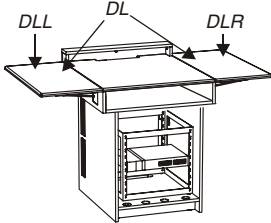

<b>Option:</b>	OPTION-UD-WP2				27	<b>254</b>
<b>User side door</b>	Add UD to model number for user side door with touch latch.					
	Shown on CRL-MF-3430-SHELF model.					

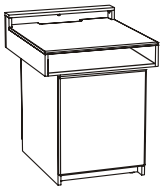

<b>Option:</b>	OPTION-MKT				15	<b>119</b>
<b>Pullout keyboard tray</b>	Add MKT to model number for molded pullout keyboard tray.					
	Shown on CRL-MF-3430-RACK-WP2 model.					

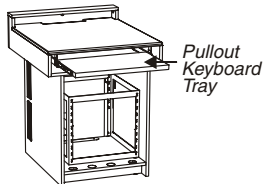

<b>Option:</b>	OPTION-LECTERN-MM-CA					<b>703</b>
<b>Casters</b>	OPTION-VENTS					<b>175</b>
	OPTION-CUTOUTS					<b>117</b>

Add CA to model number for four 2-1/2" casters, two locking. Shown on CRL-MF-3430-RACK model.

Add VENTS to model number for side and bottom vents. Shown on CRL-MF-3430-SHELF model.

Side and bottom vents are included with the RACK model.

Add CUTOUT to model number for cutouts for other options such as microphones, etc. and provide template for the required cutout. Price is for cutout only, does not include equipment.

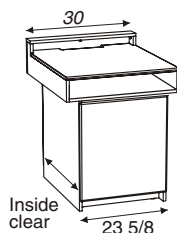
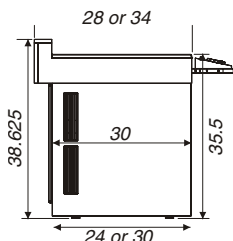

Inside Clear dimension

For 34" deep units the lower section has 30" clear on the inside front to back

For 28" deep units the lower section has 24" clear on the inside front to back

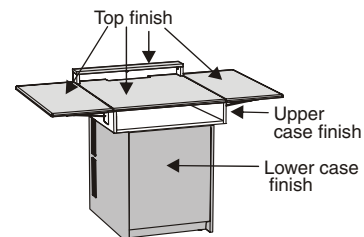

## Multimedia Lecterns

### Multimedia lecterns with sloped tops

Description	Model Number	Dimensions			Wgt	List Price
		Wide	Deep	High		
<b>Adjustable shelf</b>	CRL-MS-2828-48-SHELF	28	28	48	168	<b>2264</b>
	CRL-MS-2842-48-SHELF	28	42	48	198	<b>2668</b>

Includes door(s) on user side, adjustable shelf and finished panel on audience side.

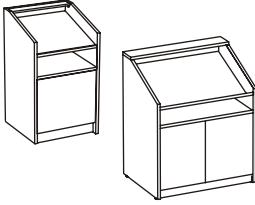

<b>Equipment Rack</b>	CRL-MS-2828-48-RACK	28	28	48	168	<b>3267</b>
	CRL-MS-2842-48-RACK	28	42	48	198	<b>3733</b>

Includes door(s) on user side, one equipment rack, side and bottom vents and audience side door(s).

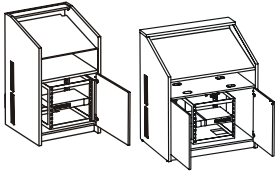

<b>Option:</b>	CRL-MS-TOP-CUTOUT					<b>391</b>
----------------	-------------------	--	--	--	--	------------

**Top Cutout** Add CUTOUT to model number for cutout in top along with monitor shelf. Shown on CRL-MS-2842-SHELF model.

Please provide clearance required for monitor.

Cannot be ordered with the KT Pullout Keyboard Tray option.



<b>Option:</b>	CRL-MS-KT	12			15	<b>364</b>
----------------	-----------	----	--	--	----	------------

**Pullout keyboard tray** Add KT to model number for pullout keyboard tray. Shown on CRL-MS-2842-SHELF model. Cannot be ordered with the TOP CUTOUT option



<b>Option:</b>	OPTION-LECTERN-MM-CA					<b>703</b>
----------------	----------------------	--	--	--	--	------------

**Casters** Add CA to model number for four 2-1/2" casters, two locking. Shown on CRL-MS-2828-SHELF model.

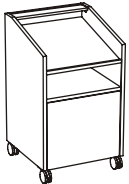

<b>Option:</b>	OPTION-VENTS					<b>175</b>
----------------	--------------	--	--	--	--	------------

**Vents** Add VENTS to Model number for side and bottom vents. Shown on CRL-MS-2828-SHELF model.

Side and bottom vents are included with the RACK model.

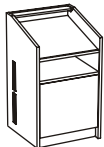

<b>Option:</b>	OPTION-CUTOUTS					<b>117</b>
----------------	----------------	--	--	--	--	------------

**Cutouts** Add cutout for other options such as microphones, etc. Price is for cutout only, does not include the equipment. Must provide a template for the required cutout.

# Credenzas - Overview

## Credenza with lower storage

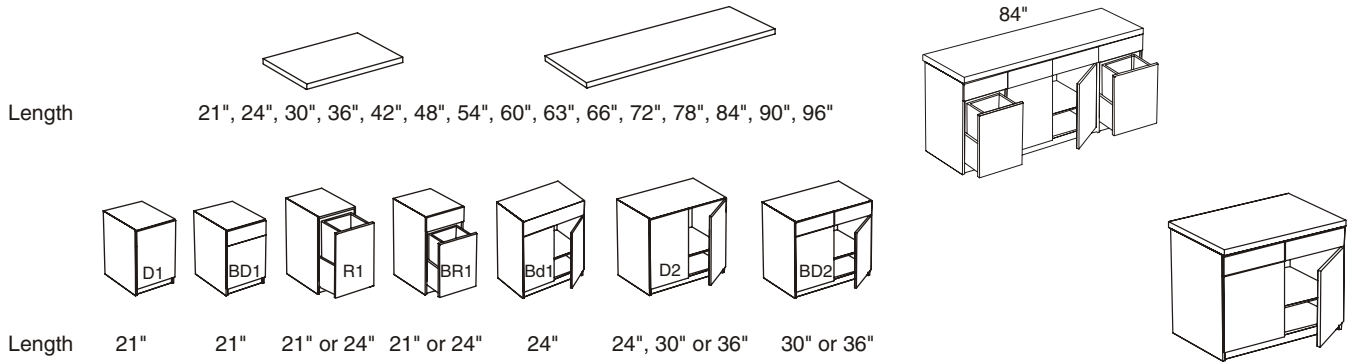

## Credenza with TRI Triangle base and box drawers

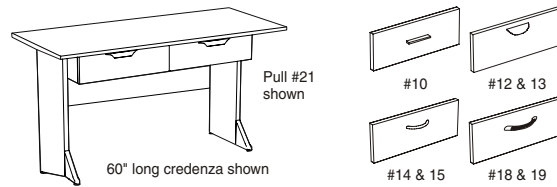

## Credenza between storage towers

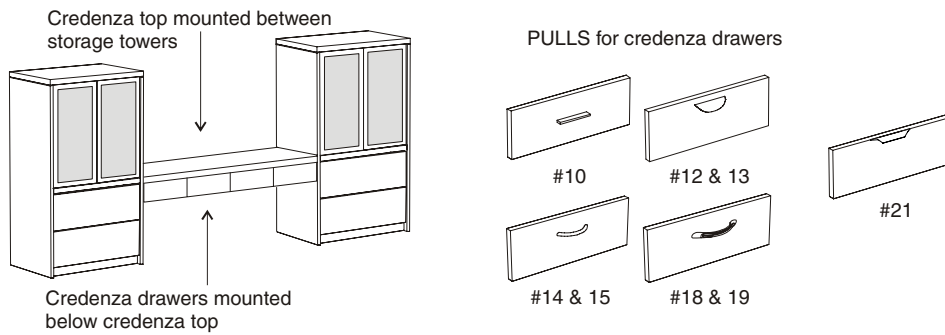

## Modular 8 style Credenza tops

Description	Model Number	Dimensions			Wgt	List Prices		
		Long	Deep	High		Wood Edges		
						WoodPlus	Standard	Detailed

### Modular 8 style credenza tops

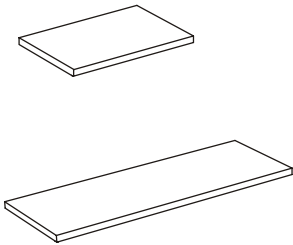

CRC-TOP-M8-2416	16	24	1.75	14	<b>179</b>	228	413
CRC-TOP-M8-2421	21	24	1.75	17	<b>199</b>	248	433
CRC-TOP-M8-2424	24	24	1.75	19	<b>199</b>	248	433
CRC-TOP-M8-2430	30	24	1.75	24	<b>235</b>	284	469
CRC-TOP-M8-2436	36	24	1.75	29	<b>261</b>	310	495
CRC-TOP-M8-2442	42	24	1.75	33	<b>265</b>	314	499
CRC-TOP-M8-2448	48	24	1.75	38	<b>265</b>	314	499
CRC-TOP-M8-2454	54	24	1.75	43	<b>378</b>	427	612
CRC-TOP-M8-2460	60	24	1.75	48	<b>378</b>	427	625
CRC-TOP-M8-2463	63	24	1.75	50	<b>413</b>	462	660
CRC-TOP-M8-2466	66	24	1.75	52	<b>413</b>	462	660
CRC-TOP-M8-2472	72	24	1.75	57	<b>413</b>	462	660
CRC-TOP-M8-2478	78	24	1.75	62	<b>417</b>	466	682
CRC-TOP-M8-2484	84	24	1.75	67	<b>417</b>	466	682
CRC-TOP-M8-2490	90	24	1.75	72	<b>513</b>	562	778
CRC-TOP-M8-2496	96	24	1.75	76	<b>513</b>	562	778
CRC-TOP-M8-24102	102	24	1.75	81	<b>643</b>	692	920
CRC-TOP-M8-24108	108	24	1.75	86	<b>643</b>	692	920
CRC-TOP-M8-24114	114	24	1.75	91	<b>643</b>	692	920
CRC-TOP-M8-24120	120	24	1.75	95	<b>643</b>	692	920

### How to specify your credenza

Choose the credenza top to determine the overall length of the credenza 72 with DET detailed wood edge

Add 2000 Series wood edge along the front of the top

Add Brushed Brass inlay along the front of the top

### Choose the lower units to fill in the credenza

Lower unit style	length		notes
BD1 Box drawer, single door	24	long	door hinges on left
R1 Recycle bin	24	long	
BD1 Box drawer, single door	24	long	door hinges on right

Total list for credenza:

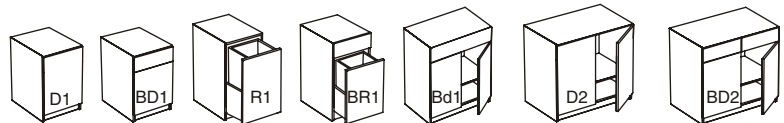

Length	21"	21"	21" or 24"	21" or 24"	24"	24", 30" or 36"	30" or 36"
--------	-----	-----	------------	------------	-----	-----------------	------------

## Modular 8 style credenza lower units

Description	Model Number	Dimensions			Wgt	List Prices		
		Long	Deep	High		Wood Edges		
						WoodPlus	Standard	Detailed

### Lower units for 29" high credenzas

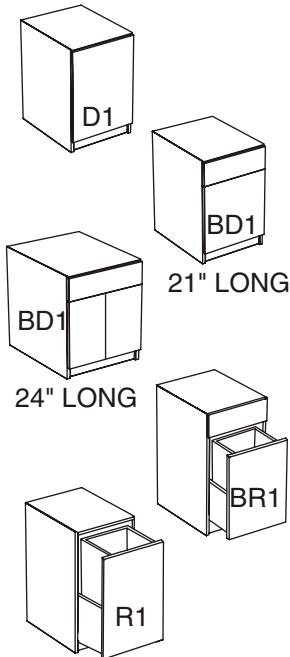

16" wide, 29" high	CRC-CAB-M8-241629-D1-L	16	24	29	82	<b>814</b>	814	814
	CRC-CAB-M8-241629-D1-R	16	24	29	82	<b>814</b>	814	814
	CRC-CAB-M8-241629-BD1-L	16	24	29	82	<b>859</b>	859	859
	CRC-CAB-M8-241629-BD1-R	16	24	29	82	<b>859</b>	859	859
Specify whether the door hinges on the LEFT or RIGHT - when facing the unit.								
21" wide, 29" high	CRC-CAB-M8-242129-D1-L	21	24	29	92	<b>814</b>	814	814
	CRC-CAB-M8-242129-D1-R	21	24	29	92	<b>814</b>	814	814
	CRC-CAB-M8-242129-BD1-L	21	24	29	92	<b>954</b>	954	954
	CRC-CAB-M8-242129-BD1-R	21	24	29	92	<b>954</b>	954	954
	CRC-CAB-M8-242129-R1	21	24	29	92	<b>859</b>	859	859
	CRC-CAB-M8-242129-BR1	21	24	29	92	<b>999</b>	999	999
Specify whether the door hinges on the LEFT or RIGHT - when facing the unit.								
24" wide, 29" high	CRC-CAB-M8-242429-D1-L	24	24	29	98	<b>814</b>	814	814
	CRC-CAB-M8-242429-D1-R	24	24	29	98	<b>814</b>	814	814
	CRC-CAB-M8-242429-BD1-L	24	24	29	98	<b>954</b>	954	954
	CRC-CAB-M8-242429-BD1-R	24	24	29	98	<b>954</b>	954	954
	CRC-CAB-M8-242429-R1	24	24	29	98	<b>859</b>	859	859
	CRC-CAB-M8-242429-BR1	24	24	29	98	<b>999</b>	999	999
Specify whether the door hinges on the LEFT or RIGHT - when facing the unit.								
30" wide, 29" high	CRC-CAB-M8-243029-D2	24	30	29	118	<b>826</b>	826	826
	CRC-CAB-M8-243029-BD2	24	30	29	118	<b>1106</b>	1106	1106
36" wide, 29" high	CRC-CAB-M8-243629-D2	24	36	29	138	<b>826</b>	826	826
	CRC-CAB-M8-243629-BD2	24	36	29	138	<b>1106</b>	1106	1106

Specify Pull for drawers, doors or recycle bins

Pair of doors and two drawers on all credenza cabinets 24" or longer.

### Lower units for 36" high credenzas

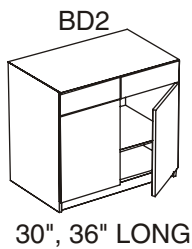
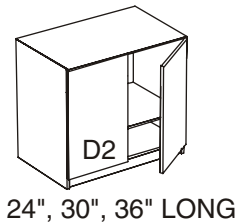

16" wide, 36" high	CRC-CAB-M8-241636-D1-L	16	24	36	82	<b>895</b>	895	895
	CRC-CAB-M8-241636-D1-R	16	24	36	82	<b>895</b>	895	895
	CRC-CAB-M8-241636-BD1-L	16	24	36	82	<b>945</b>	945	945
	CRC-CAB-M8-241636-BD1-R	16	24	36	82	<b>945</b>	945	945
Specify whether the door hinges on the LEFT or RIGHT - when facing the unit.								
21" wide, 36" high	CRC-CAB-M8-242136-D1-L	21	24	36	92	<b>895</b>	895	895
	CRC-CAB-M8-242136-D1-R	21	24	36	92	<b>895</b>	895	895
	CRC-CAB-M8-242136-BD1-L	21	24	36	92	<b>1035</b>	1035	1035
	CRC-CAB-M8-242136-BD1-R	21	24	36	92	<b>1035</b>	1035	1035
	CRC-CAB-M8-242136-R1	21	24	36	92	<b>945</b>	945	945
	CRC-CAB-M8-242136-BR1	21	24	36	92	<b>1085</b>	1085	1085
Specify whether the door hinges on the LEFT or RIGHT - when facing the unit.								
24" wide, 36" high	CRC-CAB-M8-242436-D1-L	24	24	36	98	<b>895</b>	895	895
	CRC-CAB-M8-242436-D1-R	24	24	36	98	<b>895</b>	895	895
	CRC-CAB-M8-242436-BD1-L	24	24	36	98	<b>1035</b>	1035	1035
	CRC-CAB-M8-242436-BD1-R	24	24	36	98	<b>1035</b>	1035	1035
	CRC-CAB-M8-242436-R1	24	24	36	98	<b>945</b>	945	945
	CRC-CAB-M8-242436-BR1	24	24	36	98	<b>1085</b>	1085	1085
Specify whether the door hinges on the LEFT or RIGHT - when facing the unit.								
30" wide, 36" high	CRC-CAB-M8-243036-D2	24	30	36	118	<b>909</b>	909	909
	CRC-CAB-M8-243036-BD2	24	30	36	118	<b>1189</b>	1189	1189
36" wide, 36" high	CRC-CAB-M8-243636-D2	24	36	36	138	<b>909</b>	909	909
	CRC-CAB-M8-243636-BD2	24	36	36	138	<b>1189</b>	1189	1189

Pair of doors and two drawers on all credenza cabinets 24" or longer.

## Equations Standard style Credenza tops

Description	Model Number	Dimensions			Wgt	List Prices		
		Long	Deep	High		Wood Edges		
						WoodPlus	Standard	Detailed

### Equations Standard style credenza tops

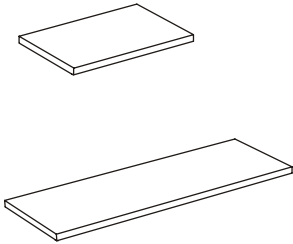

CRC-TOP-EQ-2416	16	24	1.75	14	<b>179</b>	228	413
CRC-TOP-EQ-2421	21	24	1.75	17	<b>199</b>	248	433
CRC-TOP-EQ-2424	24	24	1.75	19	<b>199</b>	248	433
CRC-TOP-EQ-2430	30	24	1.75	24	<b>235</b>	284	469
CRC-TOP-EQ-2436	36	24	1.75	29	<b>261</b>	310	495
CRC-TOP-EQ-2442	42	24	1.75	33	<b>265</b>	314	499
CRC-TOP-EQ-2448	48	24	1.75	38	<b>265</b>	314	499
CRC-TOP-EQ-2454	54	24	1.75	43	<b>378</b>	427	612
CRC-TOP-EQ-2460	60	24	1.75	48	<b>378</b>	427	625
CRC-TOP-EQ-2463	63	24	1.75	50	<b>413</b>	462	660
CRC-TOP-EQ-2466	66	24	1.75	52	<b>413</b>	462	660
CRC-TOP-EQ-2472	72	24	1.75	57	<b>413</b>	462	660
CRC-TOP-EQ-2478	78	24	1.75	62	<b>417</b>	466	682
CRC-TOP-EQ-2484	84	24	1.75	67	<b>417</b>	466	682
CRC-TOP-EQ-2490	90	24	1.75	72	<b>513</b>	562	778
CRC-TOP-EQ-2496	96	24	1.75	76	<b>513</b>	562	778
CRC-TOP-EQ-24102	102	24	1.75	81	<b>643</b>	692	920
CRC-TOP-EQ-24108	108	24	1.75	86	<b>643</b>	692	920
CRC-TOP-EQ-24114	114	24	1.75	91	<b>643</b>	692	920
CRC-TOP-EQ-24120	120	24	1.75	95	<b>643</b>	692	920

### How to specify your credenza

List Price

Choose the credenza top to determine the overall length of the credenza 72 with DET detailed wood edge

Add 2000 Series wood edge along the front of the top

Add Brushed Brass inlay along the front of the top

### Choose the lower units to fill in the credenza

Lower unit style	length		notes
BD1 Box drawer, single door	24	long	door hinges on left
R1 Recycle bin	24	long	
BD1 Box drawer, single door	24	long	door hinges on right

Total list for credenza:

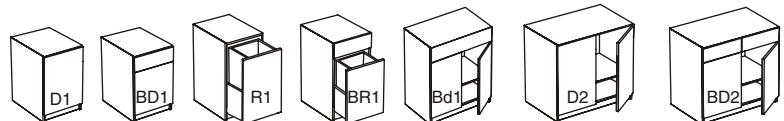

Length	21"	21"	21" or 24"	21" or 24"	24"	24", 30" or 36"	30" or 36"
--------	-----	-----	------------	------------	-----	-----------------	------------



## Equations Standard style credenza lower units

Description	Model Number	Dimensions			Wgt	List Prices		
		Long	Deep	High		Wood Edges		
						WoodPlus	Standard	Detailed

### Lower units for 29" high credenzas

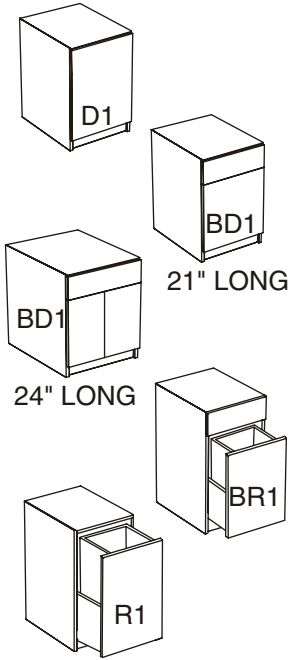

16" wide, 29" high	CRC-CAB-EQ-241629-D1-L	16	24	29	82	<b>814</b>	814	814
	CRC-CAB-EQ-241629-D1-R	16	24	29	82	<b>814</b>	814	814
	CRC-CAB-EQ-241629-BD1-L	16	24	29	82	<b>859</b>	859	859
	CRC-CAB-EQ-241629-BD1-R	16	24	29	82	<b>859</b>	859	859
Specify whether the door hinges on the LEFT or RIGHT - when facing the unit.								
21" wide, 29" high	CRC-CAB-EQ-242129-D1-L	21	24	29	92	<b>814</b>	814	814
	CRC-CAB-EQ-242129-D1-R	21	24	29	92	<b>814</b>	814	814
	CRC-CAB-EQ-242129-BD1-L	21	24	29	92	<b>954</b>	954	954
	CRC-CAB-EQ-242129-BD1-R	21	24	29	92	<b>954</b>	954	954
	CRC-CAB-EQ-242129-R1	21	24	29	92	<b>859</b>	859	859
	CRC-CAB-EQ-242129-BR1	21	24	29	92	<b>999</b>	999	999
Specify whether the door hinges on the LEFT or RIGHT - when facing the unit.								
24" wide, 29" high	CRC-CAB-EQ-242429-D1-L	24	24	29	98	<b>814</b>	814	814
	CRC-CAB-EQ-242429-D1-R	24	24	29	98	<b>814</b>	814	814
	CRC-CAB-EQ-242429-BD1-L	24	24	29	98	<b>954</b>	954	954
	CRC-CAB-EQ-242429-BD1-R	24	24	29	98	<b>954</b>	954	954
	CRC-CAB-EQ-242429-R1	24	24	29	98	<b>859</b>	859	859
	CRC-CAB-EQ-242429-BR1	24	24	29	98	<b>999</b>	999	999
Specify whether the door hinges on the LEFT or RIGHT - when facing the unit.								
30" wide, 29" high	CRC-CAB-EQ-243029-D2	24	30	29	118	<b>826</b>	826	826
	CRC-CAB-EQ-243029-BD2	24	30	29	118	<b>1106</b>	1106	1106
36" wide, 29" high	CRC-CAB-EQ-243629-D2	24	36	29	138	<b>826</b>	826	826
	CRC-CAB-EQ-243629-BD2	24	36	29	138	<b>1106</b>	1106	1106

Specify Pull for drawers, doors or recycle bins

Pair of doors and two drawers on all credenza cabinets 24" or longer.

### Lower units for 36" high credenzas

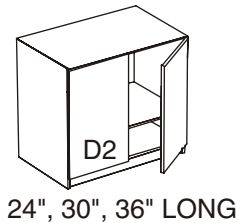

24", 30", 36" LONG

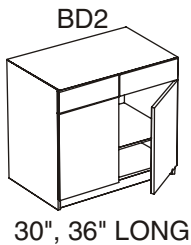

30", 36" LONG

16" wide, 36" high	CRC-CAB-EQ-241636-D1-L	16	24	36	82	<b>895</b>	895	895
	CRC-CAB-EQ-241636-D1-R	16	24	36	82	<b>895</b>	895	895
	CRC-CAB-EQ-241636-BD1-L	16	24	36	82	<b>945</b>	945	945
	CRC-CAB-EQ-241636-BD1-R	16	24	36	82	<b>945</b>	945	945
Specify whether the door hinges on the LEFT or RIGHT - when facing the unit.								
21" wide, 36" high	CRC-CAB-EQ-242136-D1-L	21	24	36	92	<b>895</b>	895	895
	CRC-CAB-EQ-242136-D1-R	21	24	36	92	<b>895</b>	895	895
	CRC-CAB-EQ-242136-BD1-L	21	24	36	92	<b>1035</b>	1035	1035
	CRC-CAB-EQ-242136-BD1-R	21	24	36	92	<b>1035</b>	1035	1035
	CRC-CAB-EQ-242136-R1	21	24	36	92	<b>945</b>	945	945
	CRC-CAB-EQ-242136-BR1	21	24	36	92	<b>1085</b>	1085	1085
Specify whether the door hinges on the LEFT or RIGHT - when facing the unit.								
24" wide, 36" high	CRC-CAB-EQ-242436-D1-L	24	24	36	98	<b>895</b>	895	895
	CRC-CAB-EQ-242436-D1-R	24	24	36	98	<b>895</b>	895	895
	CRC-CAB-EQ-242436-BD1-L	24	24	36	98	<b>1035</b>	1035	1035
	CRC-CAB-EQ-242436-BD1-R	24	24	36	98	<b>1035</b>	1035	1035
	CRC-CAB-EQ-242436-R1	24	24	36	98	<b>945</b>	945	945
	CRC-CAB-EQ-242436-BR1	24	24	36	98	<b>1085</b>	1085	1085
Specify whether the door hinges on the LEFT or RIGHT - when facing the unit.								
30" wide, 36" high	CRC-CAB-EQ-243036-D2	24	30	36	118	<b>909</b>	909	909
	CRC-CAB-EQ-243036-BD2	24	30	36	118	<b>1189</b>	1189	1189
36" wide, 36" high	CRC-CAB-EQ-243636-D2	24	36	36	138	<b>909</b>	909	909
	CRC-CAB-EQ-243636-BD2	24	36	36	138	<b>1189</b>	1189	1189

Pair of doors and two drawers on all credenza cabinets 24" or longer.

## Series 50 style Credenza tops

Description	Model Number	Dimensions			Wgt	List Prices		
		Long	Deep	High		Wood Edges		
						WoodPlus	Standard	Detailed

### Series 50 style credenza tops

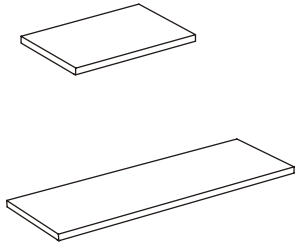

CRC-TOP-S50-2416	16	24	1.75	14	<b>179</b>	228	413
CRC-TOP-S50-2421	21	24	1.75	17	<b>199</b>	248	433
CRC-TOP-S50-2424	24	24	1.75	19	<b>199</b>	248	433
CRC-TOP-S50-2430	30	24	1.75	24	<b>235</b>	284	469
CRC-TOP-S50-2436	36	24	1.75	29	<b>261</b>	310	495
CRC-TOP-S50-2442	42	24	1.75	33	<b>265</b>	314	499
CRC-TOP-S50-2448	48	24	1.75	38	<b>265</b>	314	499
CRC-TOP-S50-2454	54	24	1.75	43	<b>378</b>	427	612
CRC-TOP-S50-2460	60	24	1.75	48	<b>378</b>	427	625
CRC-TOP-S50-2463	63	24	1.75	50	<b>413</b>	462	660
CRC-TOP-S50-2466	66	24	1.75	52	<b>413</b>	462	660
CRC-TOP-S50-2472	72	24	1.75	57	<b>413</b>	462	660
CRC-TOP-S50-2478	78	24	1.75	62	<b>417</b>	466	682
CRC-TOP-S50-2484	84	24	1.75	67	<b>417</b>	466	682
CRC-TOP-S50-2490	90	24	1.75	72	<b>513</b>	562	778
CRC-TOP-S50-2496	96	24	1.75	76	<b>513</b>	562	778
CRC-TOP-S50-24102	102	24	1.75	81	<b>643</b>	692	920
CRC-TOP-S50-24108	108	24	1.75	86	<b>643</b>	692	920
CRC-TOP-S50-24114	114	24	1.75	91	<b>643</b>	692	920
CRC-TOP-S50-24120	120	24	1.75	95	<b>643</b>	692	920

### How to specify your credenza

List Price

Choose the credenza top to determine the overall length of the credenza 72 with DET detailed wood edge





Add 2000 Series wood edge along the front of the top

Add Brushed Brass inlay along the front of the top

### Choose the lower units to fill in the credenza

Lower unit style	length		notes
BD1 Box drawer, single door	24	long	door hinges on left
R1 Recycle bin	24	long	
BD1 Box drawer, single door	24	long	door hinges on right

Total list for credenza:

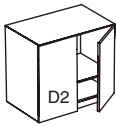
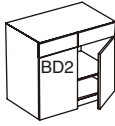
							
Length	16" or 21"	16" or 21"	21" or 24"	21" or 24"	24"	24", 30" or 36"	30" or 36"

## Series 50 style credenza lower units

Description	Model Number	Dimensions			Wgt	List Prices		
		Long	Deep	High		Wood Edges		
						WoodPlus	Standard	Detailed

### Lower units for 29" high credenzas

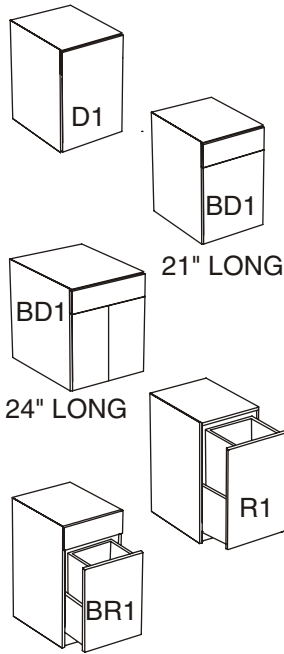

16" wide, 29" high	CRC-CAB-S50-241629-D1-L	16	24	29	82	<b>814</b>	814	814
	CRC-CAB-S50-241629-D1-R	16	24	29	82	<b>814</b>	814	814
	CRC-CAB-S50-241629-BD1-L	16	24	29	82	<b>859</b>	859	859
	CRC-CAB-S50-241629-BD1-R	16	24	29	82	<b>859</b>	859	859

Specify whether the door hinges on the LEFT or RIGHT - when facing the unit.

21" wide, 29" high	CRC-CAB-S50-242129-D1-L	21	24	29	92	<b>814</b>	814	814
	CRC-CAB-S50-242129-D1-R	21	24	29	92	<b>814</b>	814	814
	CRC-CAB-S50-242129-BD1-L	21	24	29	92	<b>954</b>	954	954
	CRC-CAB-S50-242129-BD1-R	21	24	29	92	<b>954</b>	954	954
	CRC-CAB-S50-242129-R1	21	24	29	92	<b>859</b>	859	859
	CRC-CAB-S50-242129-BR1	21	24	29	92	<b>999</b>	999	999

Specify whether the door hinges on the LEFT or RIGHT - when facing the unit.

24" wide, 29" high	CRC-CAB-S50-242429-D1-L	24	24	29	98	<b>814</b>	814	814
	CRC-CAB-S50-242429-D1-R	24	24	29	98	<b>814</b>	814	814
	CRC-CAB-S50-242429-BD1-L	24	24	29	98	<b>954</b>	954	954
	CRC-CAB-S50-242429-BD1-R	24	24	29	98	<b>954</b>	954	954
	CRC-CAB-S50-242429-R1	24	24	29	98	<b>859</b>	859	859
	CRC-CAB-S50-242429-BR1	24	24	29	98	<b>999</b>	999	999

Specify whether the door hinges on the LEFT or RIGHT - when facing the unit.

30" wide, 29" high	CRC-CAB-S50-243029-D2	24	30	29	118	<b>826</b>	826	826
	CRC-CAB-S50-243029-BD2	24	30	29	118	<b>1106</b>	1106	1106

36" wide, 29" high	CRC-CAB-S50-243629-D2	24	36	29	138	<b>826</b>	826	826
	CRC-CAB-S50-243629-BD2	24	36	29	138	<b>1106</b>	1106	1106

Specify Pull for drawers, doors or recycle bins

Pair of doors and two drawers on all credenza cabinets 24" or longer.

### Lower units for 36" high credenzas

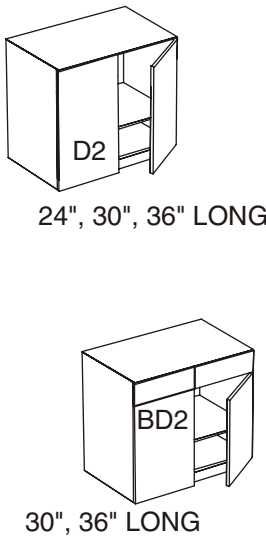

16" wide, 36" high	CRC-CAB-S50-241636-D1-L	16	24	36	82	<b>895</b>	895	895
	CRC-CAB-S50-241636-D1-R	16	24	36	82	<b>895</b>	895	895
	CRC-CAB-S50-241636-BD1-L	16	24	36	82	<b>945</b>	945	945
	CRC-CAB-S50-241636-BD1-R	16	24	36	82	<b>945</b>	945	945

Specify whether the door hinges on the LEFT or RIGHT - when facing the unit.

21" wide, 36" high	CRC-CAB-S50-242136-D1-L	21	24	36	92	<b>895</b>	895	895
	CRC-CAB-S50-242136-D1-R	21	24	36	92	<b>895</b>	895	895
	CRC-CAB-S50-242136-BD1-L	21	24	36	92	<b>1035</b>	1035	1035
	CRC-CAB-S50-242136-BD1-R	21	24	36	92	<b>1035</b>	1035	1035
	CRC-CAB-S50-242136-R1	21	24	36	92	<b>945</b>	945	945
	CRC-CAB-S50-242136-BR1	21	24	36	92	<b>1085</b>	1085	1085

Specify whether the door hinges on the LEFT or RIGHT - when facing the unit.

24" wide, 36" high	CRC-CAB-S50-242436-D1-L	24	24	36	98	<b>895</b>	895	895
	CRC-CAB-S50-242436-D1-R	24	24	36	98	<b>895</b>	895	895
	CRC-CAB-S50-242436-BD1-L	24	24	36	98	<b>1035</b>	1035	1035
	CRC-CAB-S50-242436-BD1-R	24	24	36	98	<b>1035</b>	1035	1035
	CRC-CAB-S50-242436-R1	24	24	36	98	<b>945</b>	945	945
	CRC-CAB-S50-242436-BR1	24	24	36	98	<b>1085</b>	1085	1085

Specify whether the door hinges on the LEFT or RIGHT - when facing the unit.

30" wide, 36" high	CRC-CAB-S50-243036-D2	24	30	36	118	<b>909</b>	909	909
	CRC-CAB-S50-243036-BD2	24	30	36	118	<b>1189</b>	1189	1189

36" wide, 36" high	CRC-CAB-S50-243636-D2	24	36	36	138	<b>909</b>	909	909
	CRC-CAB-S50-243636-BD2	24	36	36	138	<b>1189</b>	1189	1189

Pair of doors and two drawers on all credenza cabinets 24" or longer.

## Equations2 WoodPlus2 style Credenza tops

Description	Model Number	Dimensions			Wgt	List Prices WoodPlus2
		Long	Deep	High		

### Equations2 WP2 WoodPlus2 style credenza tops

CRC-TOP-WP2-2416	16	24	1.75	14	<b>162</b>
CRC-TOP-WP2-2421	21	24	1.75	17	<b>216</b>
CRC-TOP-WP2-2424	24	24	1.75	19	<b>216</b>
CRC-TOP-WP2-2430	30	24	1.75	24	<b>271</b>
CRC-TOP-WP2-2436	36	24	1.75	29	<b>326</b>
CRC-TOP-WP2-2442	42	24	1.75	33	<b>378</b>
CRC-TOP-WP2-2448	48	24	1.75	38	<b>434</b>
CRC-TOP-WP2-2454	54	24	1.75	43	<b>488</b>
CRC-TOP-WP2-2460	60	24	1.75	48	<b>541</b>
CRC-TOP-WP2-2463	63	24	1.75	50	<b>597</b>
CRC-TOP-WP2-2466	66	24	1.75	52	<b>597</b>
CRC-TOP-WP2-2472	72	24	1.75	57	<b>649</b>
CRC-TOP-WP2-2478	78	24	1.75	62	<b>760</b>
CRC-TOP-WP2-2484	84	24	1.75	67	<b>760</b>
CRC-TOP-WP2-2490	90	24	1.75	72	<b>868</b>
CRC-TOP-WP2-2496	96	24	1.75	76	<b>868</b>

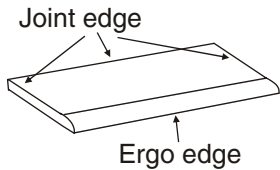

#### How to specify your credenza

List Price

**Choose the credenza top to determine the overall length of the credenza**      72      with DET detailed wood edge

Add 2000 Series wood edge along the front of the top

Add Brushed Brass inlay along the front of the top

#### Choose the lower units to fill in the credenza

Lower unit style	length		notes
BD1 Box drawer, single door	24	long	door hinges on left
R1 Recycle bin	24	long	
BD1 Box drawer, single door	24	long	door hinges on right

Total list for credenza:

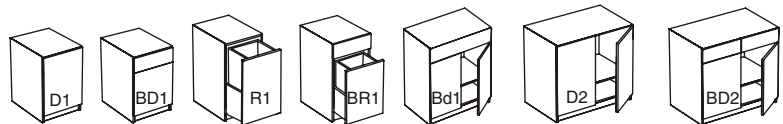

Length	21"	21"	21" or 24"	21" or 24"	24"	24", 30" or 36"	30" or 36"
--------	-----	-----	------------	------------	-----	-----------------	------------

## Equations2 WoodPlus2 style credenza lower units

Description	Model Number	Dimensions			Wgt	List Prices WoodPlus2
		Long	Deep	High		

### Lower units for 29" high credenzas

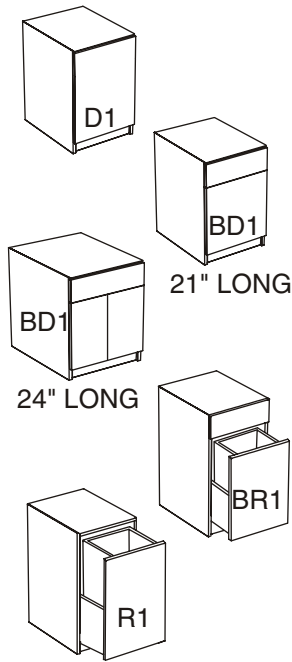

<b>16" wide,</b>	CRC-CAB-WP2-241629-D1-L	16	24	29	82	<b>814</b>
<b>29" high</b>	CRC-CAB-WP2-241629-D1-R	16	24	29	82	<b>814</b>
	CRC-CAB-WP2-241629-BD1-L	16	24	29	82	<b>859</b>
	CRC-CAB-WP2-241629-BD1-R	16	24	29	82	<b>859</b>
Specify whether the door hinges on the LEFT or RIGHT - when facing the unit.						
<b>21" wide,</b>	CRC-CAB-WP2-242129-D1-L	21	24	29	92	<b>814</b>
<b>29" high</b>	CRC-CAB-WP2-242129-D1-R	21	24	29	92	<b>814</b>
	CRC-CAB-WP2-242129-BD1-L	21	24	29	92	<b>954</b>
	CRC-CAB-WP2-242129-BD1-R	21	24	29	92	<b>954</b>
	CRC-CAB-WP2-242129-R1	21	24	29	92	<b>859</b>
	CRC-CAB-WP2-242129-BR1	21	24	29	92	<b>999</b>
Specify whether the door hinges on the LEFT or RIGHT - when facing the unit.						
<b>24" wide,</b>	CRC-CAB-WP2-242429-D1-L	24	24	29	98	<b>814</b>
<b>29" high</b>	CRC-CAB-WP2-242429-D1-R	24	24	29	98	<b>814</b>
	CRC-CAB-WP2-242429-BD1-L	24	24	29	98	<b>954</b>
	CRC-CAB-WP2-242429-BD1-R	24	24	29	98	<b>954</b>
	CRC-CAB-WP2-242429-R1	24	24	29	98	<b>859</b>
	CRC-CAB-WP2-242429-BR1	24	24	29	98	<b>999</b>
Specify whether the door hinges on the LEFT or RIGHT - when facing the unit.						
<b>30" wide,</b>	CRC-CAB-WP2-243029-D2	24	30	29	118	<b>826</b>
<b>29" high</b>	CRC-CAB-WP2-243029-BD2	24	30	29	118	<b>1106</b>
<b>36" wide,</b>	CRC-CAB-WP2-243629-D2	24	36	29	138	<b>826</b>
<b>29" high</b>	CRC-CAB-WP2-243629-BD2	24	36	29	138	<b>1106</b>

Specify Pull for drawers, doors or recycle bins

Pair of doors and two drawers on all credenza cabinets 24" or longer.

### Lower units for 36" high credenzas

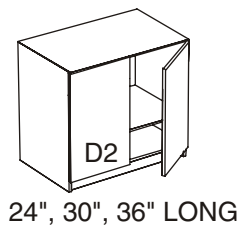

24", 30", 36" LONG

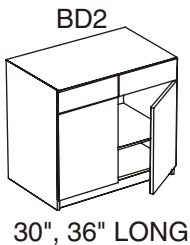

30", 36" LONG

<b>16" wide,</b>	CRC-CAB-WP2-241636-D1-L	16	24	36	82	<b>895</b>
<b>36" high</b>	CRC-CAB-WP2-241636-D1-R	16	24	36	82	<b>895</b>
	CRC-CAB-WP2-241636-BD1-L	16	24	36	82	<b>945</b>
	CRC-CAB-WP2-241636-BD1-R	16	24	36	82	<b>945</b>
Specify whether the door hinges on the LEFT or RIGHT - when facing the unit.						
<b>21" wide,</b>	CRC-CAB-WP2-242136-D1-L	21	24	36	92	<b>895</b>
<b>36" high</b>	CRC-CAB-WP2-242136-D1-R	21	24	36	92	<b>895</b>
	CRC-CAB-WP2-242136-BD1-L	21	24	36	92	<b>1035</b>
	CRC-CAB-WP2-242136-BD1-R	21	24	36	92	<b>1035</b>
	CRC-CAB-WP2-242136-R1	21	24	36	92	<b>945</b>
	CRC-CAB-WP2-242136-BR1	21	24	36	92	<b>1085</b>
Specify whether the door hinges on the LEFT or RIGHT - when facing the unit.						
<b>24" wide,</b>	CRC-CAB-WP2-242436-D1-L	24	24	36	98	<b>895</b>
<b>36" high</b>	CRC-CAB-WP2-242436-D1-R	24	24	36	98	<b>895</b>
	CRC-CAB-WP2-242436-BD1-L	24	24	36	98	<b>1035</b>
	CRC-CAB-WP2-242436-BD1-R	24	24	36	98	<b>1035</b>
	CRC-CAB-WP2-242436-R1	24	24	36	98	<b>945</b>
	CRC-CAB-WP2-242436-BR1	24	24	36	98	<b>1085</b>
<b>30" wide,</b>	CRC-CAB-WP2-243036-D2	24	30	36	118	<b>909</b>
<b>36" high</b>	CRC-CAB-WP2-243036-BD2	24	30	36	118	<b>1189</b>
<b>36" wide,</b>	CRC-CAB-WP2-243636-D2	24	36	36	138	<b>909</b>
<b>36" high</b>	CRC-CAB-WP2-243636-BD2	24	36	36	138	<b>1189</b>

Pair of doors and two drawers on all credenza cabinets 24" or longer.

## Credenzas with TRI Base and drawers

Description	Model Number	Dimensions			Wgt	List Prices		
		Long	Deep	High		Wood Edges		
						WoodPlus	Standard	Detailed

### WoodPlus Credenza Tops with TRI Triangle base and drawers

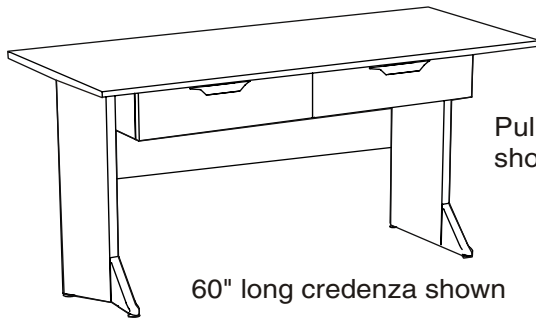

Pull #21 shown

60" long credenza shown

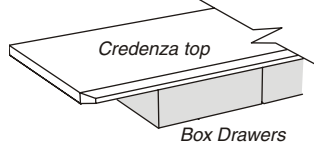
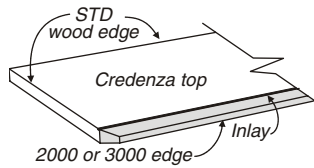
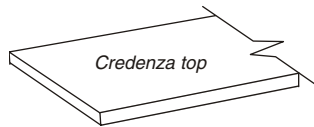
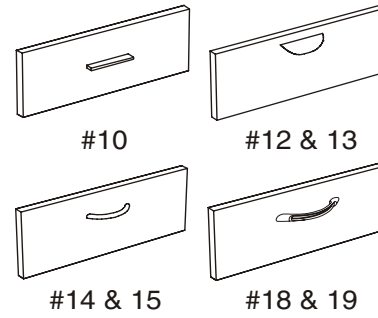

<b>Modular 8 Credenza top</b>	CRC-TOP-M8-2460	60	24	1.75	48	<b>378</b>	427	625
	CRC-TOP-M8-2466	66	24	1.75	52	<b>413</b>	462	660
	CRC-TOP-M8-2472	72	24	1.75	57	<b>413</b>	462	660
<b>Equations Standard Credenza top</b>	CRC-TOP-EQ-2460	60	24	1.125	48	<b>378</b>	427	625
	CRC-TOP-EQ-2466	66	24	1.125	52	<b>413</b>	462	660
	CRC-TOP-EQ-2472	72	24	1.125	57	<b>413</b>	462	660
<b>Series 50 Credenza top</b>	CRC-TOP-S50-2460	642	24	1.50	48	<b>378</b>	427	625
	CRC-TOP-S50-2466	66	24	1.50	52	<b>413</b>	462	660
	CRC-TOP-S50-2472	72	24	1.50	57	<b>413</b>	462	660
<b>Pair of TRI Triangle bases</b>	BASE-TRI-CRED-2429				29	<b>492</b>	492	492
	This is a pair of the TRI Triangle bases to support the credenza top and includes a half modesty panel. Please specify black or silver finish on the 'wedges'.							
<b>Drawer units</b>	CRC-TRI-DRAWERS-WP-60					<b>730</b>	730	730
	CRC-TRI-DRAWERS-WP-66					<b>777</b>	777	777
	CRC-TRI-DRAWERS-WP-72					<b>777</b>	777	777
At 60" long, two drawers, at 66" and 72" long, three drawers.								
<b>Front of top edge</b>	CREDENZA-2000-1LONG					<b>356</b>		
	CREDENZA-3000-1LONG					<b>514</b>		
For the front edge of credenza top only. Other three edges use 3mm Standard wood edge.								
<b>Inlay along front edge of top</b>	CREDENZA-INLAY-BLACK-1LONG							<b>95</b>
	CREDENZA-INLAY-BRASS-1LONG							<b>137</b>
	CREDENZA-INLAY-CHROME-1LONG							<b>137</b>
For use with the 2000 or 3000 edge along the front of the credenza top.								
<b>Inlay on all four sides of top</b>	CREDENZA-INLAY-BLACK-4SIDES							<b>275</b>
	CREDENZA-INLAY-BRASS-4SIDES							<b>413</b>
	CREDENZA-INLAY-CHROME-4SIDES							<b>413</b>
For use with the Detailed wood edge only								
<b>Pulls</b>	Pull 10, 12, 13, 14, 15, 18, 19							<b>NC</b>
	Pull 21					charge per pull:	<b>21</b>	

## Equations2 WoodPlus2 style credenza with Triangle base

Description	Model Number	Dimensions			Wgt	List Prices
		Long	Deep	High		

### WoodPlus2 Credenza Tops with TRI Triangle base and drawers

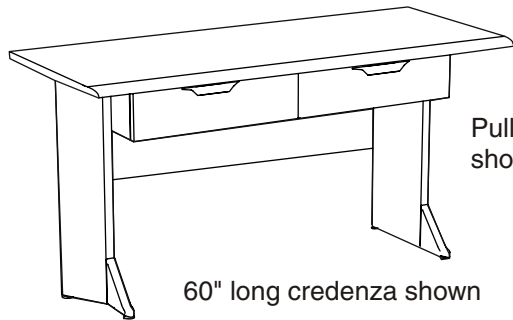

Pull #21 shown

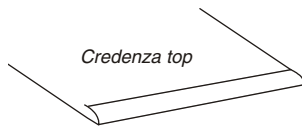
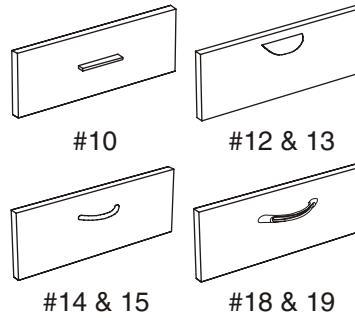

Credenza top

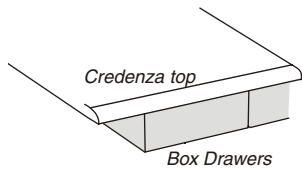

Credenza top

Box Drawers



<b>Credenza top</b>	CRC-TOP-WP2-2460	60	24	1.125	48	<b>541</b>
	CRC-TOP-WP2-2466	66	24	1.125	52	<b>597</b>
	CRC-TOP-WP2-2472	72	24	1.125	57	<b>597</b>
<b>Pair of TRI Triangle bases</b>	BASE-TRI-CRED-2429			29		<b>492</b>
	This is a pair of the TRI Triangle bases to support the credenza top and includes a half modesty panel. Please specify black or silver finish on the 'wedges'.					
<b>Drawer units</b>	CRC-TRI-DRAWERS-WP2-60					<b>730</b>
	CRC-TRI-DRAWERS-WP2-66					<b>777</b>
	CRC-TRI-DRAWERS-WP2-72					<b>777</b>
	At 60" long, two drawers, at 66" and 72" long, three drawers.					
<b>Pulls</b>	Pull 10, 12, 13, 14, 15, 18, 19					NC
	Pull 21				charge per pull:	21



## WoodPlus style credenza top between Towers

Description	Model Number	Dimensions			Wgt	List Prices		
		Long	Deep	High		Wood Edges		
						WoodPlus	Standard	Detailed

### WoodPlus Credenza Tops mounted between towers, optional drawers

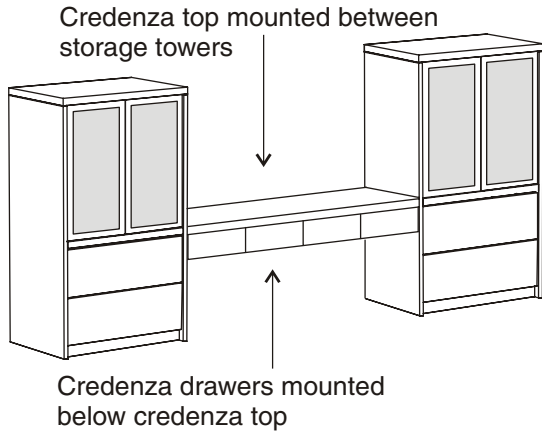

#### PULLS for credenza drawers

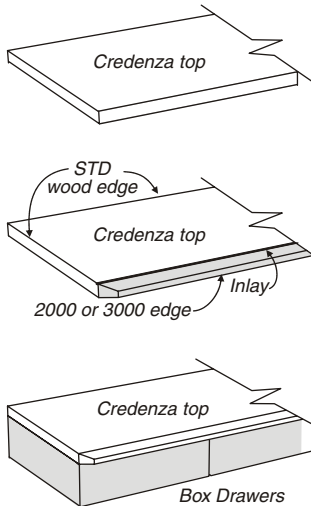
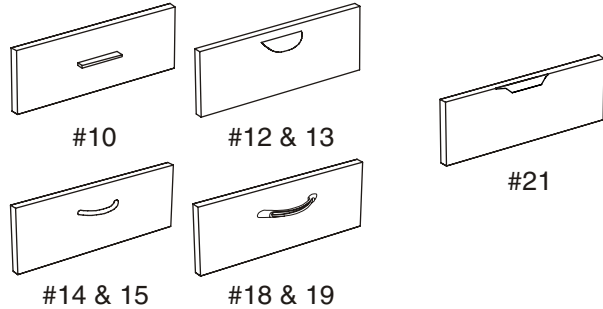

<b>Modular 8 Credenza top</b>	CRC-TOP-M8-2460	60	24	1.75	48	<b>416</b>	462	603
	CRC-TOP-M8-2466	66	24	1.75	52	<b>455</b>	501	642
	CRC-TOP-M8-2472	72	24	1.75	57	<b>455</b>	501	642
<b>Equations Standard Credenza top</b>	CRC-TOP-EQ-2460	60	24	1.125	48	<b>416</b>	462	603
	CRC-TOP-EQ-2466	66	24	1.125	52	<b>455</b>	501	642
	CRC-TOP-EQ-2472	72	24	1.125	57	<b>455</b>	501	642
<b>Series 50 Credenza top</b>	CRC-TOP-S50-2460	642	24	1.50	48	<b>416</b>	462	603
	CRC-TOP-S50-2466	66	24	1.50	52	<b>455</b>	501	642
	CRC-TOP-S50-2472	72	24	1.50	57	<b>455</b>	501	642
<b>Drawer units</b>	CREDENZA-BOX-DRWRS-WP-60					<b>665</b>	665	665
	CREDENZA-BOX-DRWRS-WP-66					<b>707</b>	707	707
	CREDENZA-BOX-DRWRS-WP-72					<b>707</b>	707	707
At 60" long, three drawers, at 66" and 72" long, four drawers.								
<b>Front of top edge</b>	CREDENZA-2000-1LONG					<b>356</b>	356	356
	CREDENZA-3000-1LONG					<b>514</b>	514	514
For the front edge of credenza top only. Other three edges use 3mm Standard wood edge. The 2000 or 3000 wood edge extends past the face of the adjacent towers.								
<b>Inlay along front edge of top</b>	CREDENZA-INLAY-BLACK-1LONG					<b>95</b>	95	95
	CREDENZA-INLAY-BRASS-1LONG					<b>137</b>	137	137
	CREDENZA-INLAY-CHROME-1LONG					<b>137</b>	137	137
For use with the 2000 or 3000 edge along the front of the credenza top.								
<b>Inlay on all four sides of top</b>	CREDENZA-INLAY-BLACK-4SIDES					<b>275</b>		
	CREDENZA-INLAY-BRASS-4SIDES					<b>413</b>		
	CREDENZA-INLAY-CHROME-4SIDES					<b>413</b>		
For use with the Detailed wood edge only								
<b>Pulls</b>	Pull 10, 12, 13, 14, 15, 18, 19					<b>NC</b>		
	Pull 21					charge per pull:	<b>21</b>	
<b>Mounting of Credenza top</b>	CRC-AB8-BRACKETS					<b>NC</b>		
	Two each AB8 brackets to mount CRC-TOP to adjacent towers.							



## Equations2 WoodPlus2 style credenza top between Towers

Description	Model Number	Dimensions			Wgt	List Prices
		Long	Deep	High		

### WoodPlus2 Credenza Tops mounted between towers, optional drawers

Credenza top mounted between storage towers

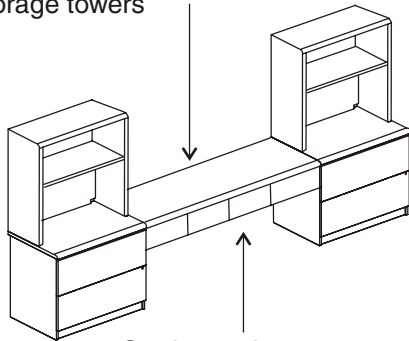

Credenza drawers mounted below credenza top

PULLS for credenza drawers

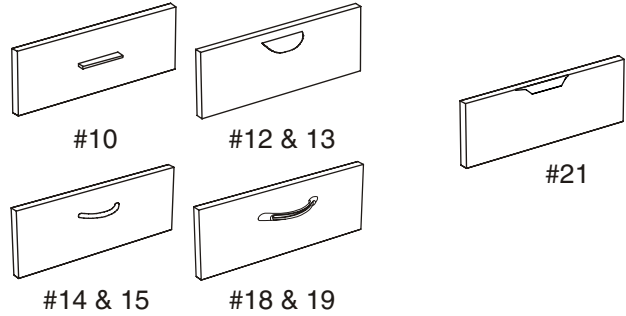

Credenza top	Model Number	Long	Deep	High	Wgt	List Prices
	CRC-TOP-WP2-2460	60	24	1.125	48	416
	CRC-TOP-WP2-2466	66	24	1.125	52	455
	CRC-TOP-WP2-2472	72	24	1.125	57	455

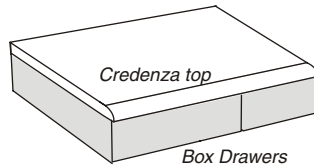

Drawer units	Model Number	List Prices
	CREDENZA-BOX-DRWRS-WP2-60	730
	CREDENZA-BOX-DRWRS-WP2-66	777
	CREDENZA-BOX-DRWRS-WP2-72	777

At 60" long, three drawers, at 66" and 72" long, four drawers.

Pulls	Model Number	List Prices
	Pull 10, 12, 13, 14, 15, 18, 19	NC
	Pull 21	charge per pull: 21

Mounting of Credenza top	Model Number	List Prices
	CRC-AB8-BRACKETS	NC

Two each AB8 brackets to mount CRC-TOP to adjacent towers.

## Occasional Tables

### Cube Tables

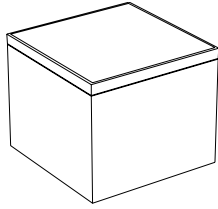

CUBE-202024-STD

Description	Model Number	Dimensions			Wgt	List Prices		
		Wide	Deep	High		Wood Edges		
						WoodPlus	Standard	Detailed
18" square	CUBE-181816	18	18	16	64	<b>531</b>	578	797
	CUBE-181820	18	18	20	73	<b>620</b>	667	886
	CUBE-181824	18	18	24	85	<b>684</b>	731	950
20" square	CUBE-202016	20	20	16	64	<b>584</b>	631	850
	CUBE-202020	20	20	20	73	<b>683</b>	730	949
	CUBE-202024	20	20	24	85	<b>790</b>	837	1056
24" square	CUBE-242416	24	24	16	86	<b>629</b>	676	895
	CUBE-242420	24	24	20	98	<b>738</b>	785	1004
	CUBE-242424	24	24	24	112	<b>855</b>	902	1121
30" square	CUBE-303016	30	30	16	94	<b>783</b>	830	1049
	CUBE-303020	30	30	20	105	<b>838</b>	885	1104
	CUBE-303030	30	30	30	116	<b>955</b>	1002	1221
36" square	CUBE-363616	36	36	16	140	<b>899</b>	946	1165
	CUBE-363620	36	36	20	156	<b>950</b>	997	1216

### Drum Tables

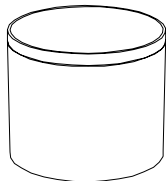

DRUM-2024-STD

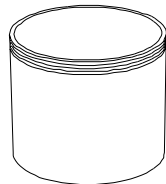

DRUM-2024-RE

20" diameter	DRUM-2018	20	18	61	<b>575</b>	622	841
	DRUM-2020	20	20	66	<b>685</b>	732	951
	DRUM-2024	20	24	80	<b>790</b>	837	1056
24" diameter	DRUM-2418	24	18	77	<b>704</b>	751	970
	DRUM-2420	24	20	83	<b>829</b>	876	1095
	DRUM-2424	24	24	100	<b>951</b>	998	1217
30" diameter	DRUM-3018	30	18	106	<b>908</b>	955	1174
	DRUM-3020	30	20	114	<b>1088</b>	1135	1354
	DRUM-3024	30	24	137	<b>1269</b>	1316	1535

### Edge Options Information

Cube and Drum Tables are available with the following edge options:

- WoodPlus 3 mm PVC edge
- Standard 3 mm Wood Edge
- Detailed 3/8" Wood Edge

Cube table vertical corners are eased to 3 mm radius.

WoodPlus 3 mm PVC	Standard Wood	Detailed Wood
Equations WPES	Equations SWES	RE
Modular 8 WPER	Modular 8 SWER	RA
WPMS	SWMS	BE
WPEN	SWEN	TR
WPMN	SWMN	CL
WPMR	SWMR	

# Storage Towers with Lateral File drawers

## Overview - Storage Towers with Lateral Files

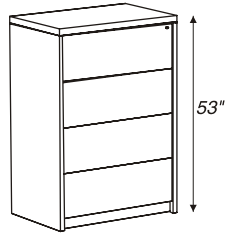

Lateral File:  
30" or 36" wide, 24" deep

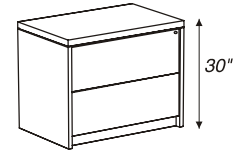
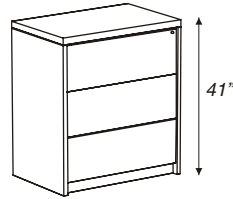

Storage Towers - Rectangular Top, 2, 3 or 4 Lateral File Drawers, see Pg 138

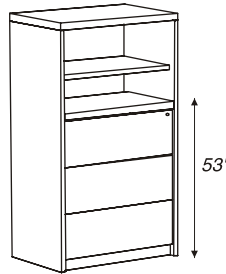

65" or 72" high with Lateral File  
30" or 36" wide, 24" deep

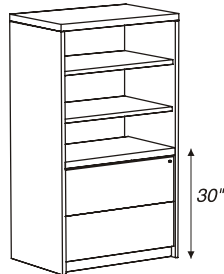

OPTIONAL HINGED DOORS  
Full Height Hinged Upper Doors  
Upper Hinged Door (UD)  
Lateral File Drawers below

Storage Towers - Rectangular Top, 65" high, Lateral File Drawers, storage above, see Pg 138

Figure , "Add Upper Hinged Doors," on page 144

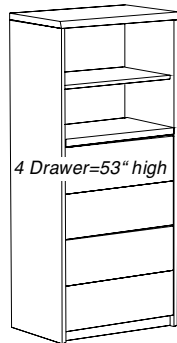

84" high Storage with Lateral File  
30" or 36" wide, 84" high, 24" deep

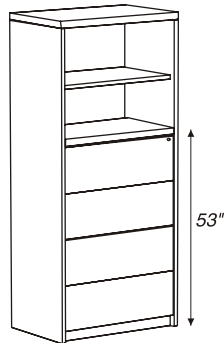

84" high Storage with Lateral File  
30" or 36" wide, 84" high, 24" deep

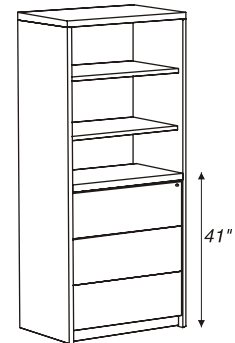

Storage Towers - Rectangular Top, 84" high with Lateral File Drawers and storage above, see Pg 140

## Storage Towers with Lateral File drawers

### Storage Towers - Rectangular Top, 2, 3 or 4 Lateral File Drawers

Description	Model Number	List Prices - Laminate			Dimensions			Wgt
		Wood Edges			Wide	Deep	High	
		WoodPlus	Standard	Detailed				
<b>2 Lateral File Drawers</b>	ST8-2LF-3029-24-LOCK	<b>1645</b>	1790	1935	30	24	29	274
	ST8-2LF-3629-24-LOCK	<b>1645</b>	1790	1935	36	24	29	284

Specify Pull number.

<b>3 Lateral File Drawers</b>	ST8-3LF-3041-24-LOCK	<b>1989</b>	2134	2279	30	24	41	281
	ST8-3LF-3641-24-LOCK	<b>1989</b>	2134	2279	36	24	41	293

Specify Pull number.

<b>4 Lateral File Drawers</b>	ST8-4LF-3053-24-LOCK	<b>2321</b>	2466	2611	30	24	53	288
	ST8-4LF-3653-24-LOCK	<b>2321</b>	2466	2611	36	24	53	301

Specify Pull number.

### Storage Towers - Rectangular Top, 65" high, Lateral File Drawers, storage above

<b>2 Lateral Files, 65" high</b>	ST8-2LF-3065-24-LOCK	<b>2196</b>	2389	2553	30	24	65	274
	ST8-2LF-3665-24-LOCK	<b>2253</b>	2446	2610	36	24	65	284

Specify Pull number.

<b>3 Lateral Files, 65" high</b>	ST8-3LF-3065-24-LOCK	<b>2504</b>	2697	2861	30	24	65	281
	ST8-3LF-3665-24-LOCK	<b>2562</b>	2755	2919	36	24	65	293

Specify Pull number.

#### Lateral File Pull Options

Tower shelf finish matches case finish.

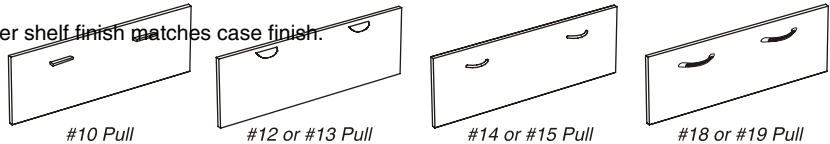

#### Edge Options Information

Modular 8 Tops are 1 3/4" thick, available with the following edge options:

#### WoodPlus (PVC)

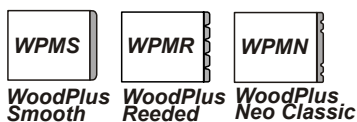

WoodPlus 3 mm PVC edge:  
 WPMS - 3 mm Smooth  
 WPMR - 3 mm Reeded  
 WPMN - 3 mm Neo Classic

WoodPlus 3 mm PVC edge:  
 WPMS - 3 mm Smooth  
 WPMR - 3 mm Reeded  
 WPMN - 3 mm Neo Classic

#### Standard Wood Edges



Standard 3 mm Wood Edge:  
 SWMS - 3 mm Radius  
 SWMR - 3 mm Reeded  
 SWMN - 3 mm NeoClassic

Standard 3 mm Wood Edge:  
 SWMS - 3 mm Radius  
 SWMR - 3 mm Reeded  
 SWMN - 3 mm NeoClassic

#### Detailed Wood Edges

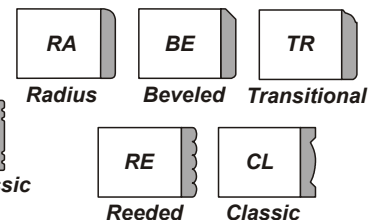

Detailed 3/8" Wood Edge:  
 RA - Radius  
 BE - Beveled  
 TR - Transitional  
 RE - Reeded  
 CL - Classic

## Storage Towers with Lateral File drawers

### Storage Towers - Rectangular Top, 72" high with Lateral File Drawers and storage above

Description	Model Number	List Prices - Laminate			Dimensions			Wgt
		Wood Edges			Wide	Deep	High	
		WoodPlus	Standard	Detailed				
<b>2 Lateral Files, 72" high</b>	ST8-2LF-3072-24-LOCK	<b>2244</b>	2437	2601	30	24	72	310
	ST8-2LF-3672-24-LOCK	<b>2300</b>	2493	2657	36	24	72	322

Specify Pull number.

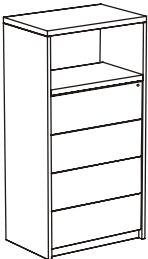
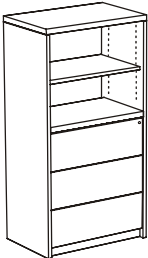
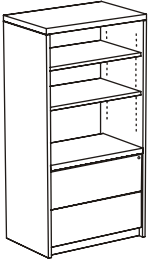

<b>3 Lateral Files, 72" high</b>	ST8-3LF-3072-24-LOCK	<b>2551</b>	2744	2908	30	24	72	317
	ST8-3LF-3672-24-LOCK	<b>2609</b>	2802	2966	36	24	72	331

Specify Pull number.

<b>4 Lateral Files, 72" high</b>	ST8-4LF-3072-24-LOCK	<b>2934</b>	3127	3291	30	24	72	324
	ST8-4LF-3672-24-LOCK	<b>2997</b>	3190	3354	36	24	72	339

Specify Pull number.

Tower shelf finish matches case finish.

#### Options

Options are built-in at factory

Upper Hinged Doors: UHD  
Specify Door Pull number.

Upper Glass Hinged Doors,  
Aluminum Frame UGDA or  
WoodPlus Frame UGW

GRV End Panel Grommet

#### Accessories

Order Separately

ESH Extra Shelf, WoodPlus edge  
ESH Extra Shelf, Wood edge

Please specify cabinet.

For information on these and other available options and accessories, please see the end of this section.

**See end of this section for pricing on all Options and Accessories**

## Storage Towers with Lateral File drawers

### Storage Towers - Rectangular Top, 84" high with Lateral File Drawers and storage above

Description	Model Number	List Prices - Laminate			Dimensions			Wgt
		Wood Edges			Wide	Deep	High	
		WoodPlus	Standard	Detailed				
<b>2 Lateral Files, 84" high</b>	ST8-2LF-3084-24-LOCK	<b>2362</b>	2555	2719	30	24	84	310
	ST8-2LF-3684-24-LOCK	<b>2427</b>	2620	2784	36	24	84	322

Specify Pull number.

<b>3 Lateral Files, 84" high</b>	ST8-3LF-3084-24-LOCK	<b>2672</b>	2865	3029	30	24	84	317
	ST8-3LF-3684-24-LOCK	<b>2735</b>	2928	3092	36	24	84	331

Specify Pull number.

<b>4 Lateral Files, 84" high</b>	ST8-4LF-3084-24-LOCK	<b>2981</b>	3174	3338	30	24	84	324
	ST8-4LF-3684-24-LOCK	<b>3045</b>	3238	3402	36	24	84	339

Specify Pull number.

Tower shelf finish matches case finish.

#### Lateral File Pull Options

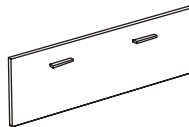

#10 Pull

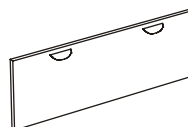

#12 or #13 Pull

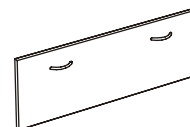

#14 or #15 Pull

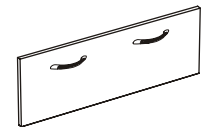

#18 or #19 Pull

#### Edge Options Information

Modular 8 Tops are 1 3/4" thick, available with the following edge options:

#### WoodPlus (PVC)



WoodPlus Smooth



WoodPlus Reeded



WoodPlus Neo Classic

WoodPlus 3 mm PVC edge:  
 WPMS - 3 mm Smooth  
 WPMR - 3 mm Reeded  
 WPMN - 3 mm Neo Classic

#### Standard Wood Edges



Standard Smooth



Standard Reeded



Standard NeoClassic

Standard 3 mm Wood Edge:  
 SWMS - 3 mm Radius  
 SWMR - 3 mm Reeded  
 SWMN - 3 mm NeoClassic

#### Detailed Wood Edges



Radius



Beveled



Transitional



Reeded

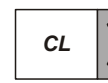

Classic

Detailed 3/8" Wood Edge:  
 RA - Radius  
 BE - Beveled  
 TR - Transitional  
 RE - Reeded  
 CL - Classic

## Storage Towers with Lateral File drawers

### Storage Towers - Bow Front Top, 2, 3 or 4 Lateral File Drawers

Description	Model Number	List Prices - Laminate			Dimensions			Wgt
		Wood Edges			Wide	Deep	High	
		WoodPlus	Standard	Detailed				
<b>2 Lateral File Drawers</b>	STB8-2LF-3029-24-LOCK	<b>1677</b>	1816	1957	30	24	29	274
	STB8-2LF-3629-24-LOCK	<b>1677</b>	1816	1957	36	24	29	284

Specify Pull number.

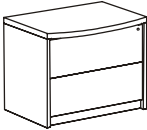
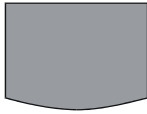

<b>3 Lateral File Drawers</b>	STB8-3LF-3041-24-LOCK	<b>2094</b>	2239	2384	30	24	41	281
	STB8-3LF-3641-24-LOCK	<b>2094</b>	2239	2384	36	24	41	293

Specify Pull number.

<b>4 Lateral File Drawers</b>	STB8-4LF-3053-24-LOCK	<b>2426</b>	2571	2716	30	24	53	288
	STB8-4LF-3653-24-LOCK	<b>2426</b>	2571	2716	36	24	53	301

Specify Pull number.

### Storage Towers - Bow Front Top, 65" high, Lateral File Drawers, storage above

<b>2 Lateral Files, 65" high</b>	STB8-2LF-3065-24-LOCK	<b>2408</b>	2601	2765	30	24	65	274
	STB8-2LF-3665-24-LOCK	<b>2466</b>	2659	2823	36	24	65	284

Specify Pull number.

<b>3 Lateral Files, 65" high</b>	STB8-3LF-3065-24-LOCK	<b>2716</b>	2909	3073	30	24	65	281
	STB8-3LF-3665-24-LOCK	<b>2775</b>	2968	3132	36	24	65	293

Specify Pull number.

Tower shelf finish matches case finish.

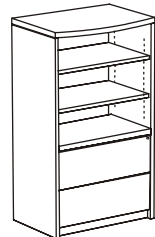

#### Options

Options are built-in at factory

Upper Hinged Doors: UHD  
Specify Door Pull number.

Upper Glass Hinged Doors,  
Aluminum Frame UGDA or  
WoodPlus Frame UGW

GRV End Panel Grommet

#### Accessories

Order Separately

ESH Extra Shelf, WoodPlus edge  
ESH Extra Shelf, Wood edge

Please specify cabinet.

For information on these and other available options and accessories, please see the end of this section.

**See end of this section for pricing on all Options and Accessories**

## Storage Towers with Lateral File drawers

### Storage Towers - Bow Front Top, 72" high with Lateral File Drawers and storage above

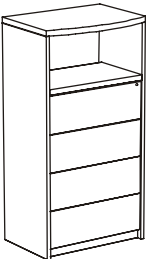
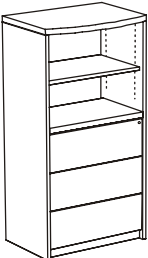
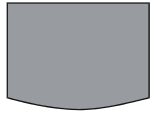

Description	Model Number	List Prices - Laminate			Dimensions			Wgt
		Wood Edges			Wide	Deep	High	
		WoodPlus	Standard	Detailed				
<b>2 Lateral Files, 72" high</b>	STB8-2LF-3072-24-LOCK	<b>2457</b>	2650	2814	30	24	72	310
	STB8-2LF-3672-24-LOCK	<b>2513</b>	2706	2870	36	24	72	322

Specify Pull number.

<b>3 Lateral Files, 72" high</b>	STB8-3LF-3072-24-LOCK	<b>2764</b>	2957	3121	30	24	72	317
	STB8-3LF-3672-24-LOCK	<b>2822</b>	3015	3179	36	24	72	331

Specify Pull number.

<b>4 Lateral Files, 72" high</b>	STB8-4LF-3072-24-LOCK	<b>3146</b>	3339	3503	30	24	72	324
	STB8-4LF-3672-24-LOCK	<b>3208</b>	3401	3565	36	24	72	339

Specify Pull number.

Tower shelf finish matches case finish.

#### Lateral File Pull Options

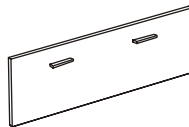

#10 Pull

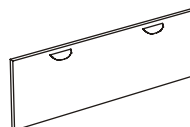

#12 or #13 Pull

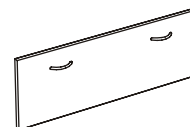

#14 or #15 Pull

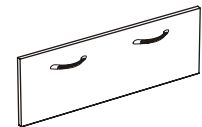

#18 or #19 Pull

#### Edge Options Information

Modular 8 Tops are 1 3/4" thick, available with the following edge options:

#### WoodPlus (PVC)



WoodPlus Smooth



WoodPlus Reeded



WoodPlus Neo Classic

WoodPlus 3 mm PVC edge:  
 WPMS - 3 mm Smooth  
 WPMR - 3 mm Reeded  
 WPMN - 3 mm Neo Classic

#### Standard Wood Edges



Standard Smooth



Standard Reeded



Standard NeoClassic

Standard 3 mm Wood Edge:  
 SWMS - 3 mm Radius  
 SWMR - 3 mm Reeded  
 SWMN - 3 mm NeoClassic

#### Detailed Wood Edges



Radius



Beveled



Transitional



Reeded

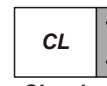

Classic

Detailed 3/8" Wood Edge:  
 RA - Radiused  
 BE - Beveled  
 TR - Transitional  
 RE - Reeded  
 CL - Classic



## Storage Towers with Lateral File drawers

### Storage Towers - Bow Front Top, 84" high with Lateral File Drawers and storage above

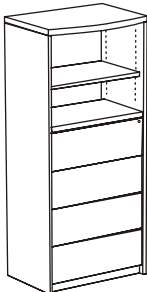
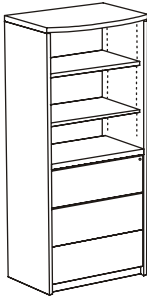
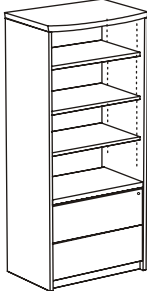
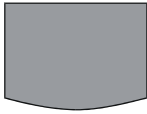

Description	Model Number	List Prices - Laminate			Dimensions			Wgt
		Wood Edges			Wide	Deep	High	
		WoodPlus	Standard	Detailed				
<b>2 Lateral Files, 84" high</b>	STB8-2LF-3084-24-LOCK	<b>2574</b>	2767	2931	30	24	84	310
	STB8-2LF-3684-24-LOCK	<b>2639</b>	2832	2996	36	24	84	322

Specify Pull number.

<b>3 Lateral Files, 84" high</b>	STB8-3LF-3084-24-LOCK	<b>2883</b>	3076	3240	30	24	84	317
	STB8-3LF-3684-24-LOCK	<b>2947</b>	3140	3304	36	24	84	331

Specify Pull number.

<b>4 Lateral Files, 84" high</b>	STB8-4LF-3084-24-LOCK	<b>3193</b>	3386	3550	30	24	84	324
	STB8-4LF-3684-24-LOCK	<b>3256</b>	3449	3613	36	24	84	339

Specify Pull number.

Tower shelf finish matches case finish.

#### Options

Options are built-in at factory

Upper Hinged Doors: UHD  
Specify Door Pull number.

Upper Glass Hinged Doors,  
Aluminum Frame UGDA or  
WoodPlus Frame UGW

GRV End Panel Grommet

#### Accessories

Order Separately

ESH Extra Shelf, WoodPlus edge  
ESH Extra Shelf, Wood edge

Please specify cabinet.

For information on these and other available options and accessories, please see the end of this section.

**See end of this section for pricing on all Options and Accessories**

## Storage Towers with Lateral File drawers

### Options for Storage Towers with Lateral Files

Description	Model Number	List Price	Dimensions			Wgt
			Wide	Deep	High	
<b>Add Upper Hinged Doors</b>	OPTION-UHD Specify Door Pull number.	<b>353</b>				33
<b>Lock Upper Hinged Doors</b>	OPTION-LOCK-PAIR-DOORS	<b>87</b>				

#### DoorPull Options

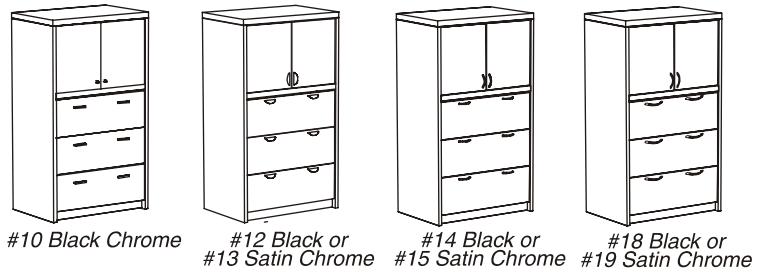

### Options GDA Glass Doors with Aluminum or WoodPlus2 frames

<b>Add Glass Doors</b>	OPTION-UGA	<b>791</b>				45
	OPTION-UGW	<b>791</b>				45

Glass is frosted. No pulls or locks available with glass doors.  
 GDA is frosted glass door with Aluminum frame.  
 GDW is frosted glass door with WoodPlus2 frame.  
 WoodPlus2 glass door frames are detailed to match Modular 8 details.  
 Specify WP2 or XTRA WP2 finish for the door frames.  
 Note that the XTRA WP2 upcharge applies when choosing an XTRA WP2 finish.  
**MAGNA NOW! Glass doors NOT available on MAGNA NOW!**

#### Glass Door illustrations

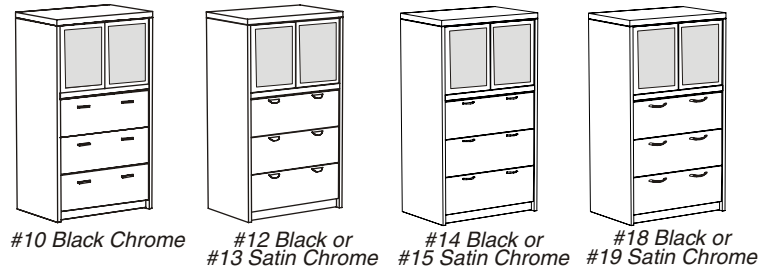

### Accessories for Storage Towers

<b>Extra adjustable shelf - any size</b>	ESH-WPE	<b>57</b>				15
	ESH-STD	<b>82</b>				15

Tower shelves match tower vertical finish.



<b>Tasklights</b>	WL24	<b>79</b>	21	7	2	3
	WL30	<b>86</b>	27	7	2	3

For access to Task Light cord, please order Vertical Grommet option (GRV) in Tower.

## Storage Towers - Bookcases

### Storage Tower Bookcases - Rectangular Top, Black Hardboard Back

Description	Model Number	List Prices - Laminate			Dimensions			Wgt
		Wood Edges			Wide	Deep	High	
		WoodPlus	Standard	Detailed				
<b>30" wide, 12" deep Black Back</b>	ST8-BCK-3029-12	570	715	860	30	12	29	64
	ST8-BCK-3036-12	622	767	912	30	12	36	69
	ST8-BCK-3042-12	654	799	944	30	12	42	79
	ST8-BCK-3048-12	687	832	977	30	12	48	89
	ST8-BCK-3060-12	788	933	1078	30	12	60	108
	ST8-BCK-3065-12	839	984	1129	30	12	65	121
	ST8-BCK-3072-12	885	1030	1175	30	12	72	131
	ST8-BCK-3084-12	963	1108	1253	30	12	84	148
Doors NOT available; use ST8-SC cabinets. Shelf finish matches case finish.								
<b>30" wide, 15" deep Black Back</b>	ST8-BCK-3029-15	570	715	860	30	15	29	73
	ST8-BCK-3036-15	622	767	912	30	15	36	77
	ST8-BCK-3042-15	654	799	944	30	15	42	78
	ST8-BCK-3048-15	687	832	977	30	15	48	99
	ST8-BCK-3060-15	788	933	1078	30	15	60	151
	ST8-BCK-3065-15	839	984	1129	30	15	65	139
	ST8-BCK-3072-15	885	1030	1175	30	15	72	150
	ST8-BCK-3084-15	963	1108	1253	30	15	84	170
Doors NOT available; use ST8-SC cabinets. Shelf finish matches case finish.								
<b>36" wide, 12" deep Black Back</b>	ST8-BCK-3629-12	570	715	860	36	12	29	70
	ST8-BCK-3636-12	622	767	912	36	12	36	77
	ST8-BCK-3642-12	654	799	944	36	12	42	88
	ST8-BCK-3648-12	687	832	977	36	12	48	96
	ST8-BCK-3660-12	788	933	1078	36	12	60	120
	ST8-BCK-3665-12	857	1002	1147	36	12	65	134
	ST8-BCK-3672-12	903	1048	1193	36	12	72	145
	ST8-BCK-3684-12	981	1126	1271	36	12	84	164
Doors NOT available; use ST8-SC cabinets. Shelf finish matches case finish.								
<b>36" wide, 15" deep Black Back</b>	ST8-BCK-3629-15	570	715	860	36	15	29	81
	ST8-BCK-3636-15	622	767	912	36	15	36	86
	ST8-BCK-3642-15	654	799	944	36	15	42	99
	ST8-BCK-3648-15	687	832	977	36	15	48	110
	ST8-BCK-3660-15	788	933	1078	36	15	60	168
	ST8-BCK-3665-15	857	1002	1147	36	15	65	154
	ST8-BCK-3672-15	903	1048	1193	36	15	72	167
	ST8-BCK-3684-15	981	1126	1271	36	15	84	189
Doors NOT available; use ST8-SC cabinets. Shelf finish matches case finish.								

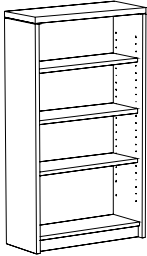

NOTES:  
Shelf depth on 12" deep units is 10-1/2"  
Shelf depth on 15" deep units is 13-1/2"  
Weight limit is 100 lb per shelf.  
Shelves are adjustable on 2" increments.

**Please Note:**  
29" high units will not accommodate two rows of binders.

**Options**  
Options are built-in at factory  
GRV End Panel Grommet

**Accessories**  
Order Separately  
ESHExtra Shelf, WoodPlus edge  
ESHExtra Shelf, Wood edge  
Please specify cabinet.

For information on these and other available options and accessories, please see the end of this section.

**See end of this section for pricing on all Options and Accessories**

# Storage Towers - Bookcases

## Storage Tower Bookcases - Rectangular Top, 3/4" Finished Back

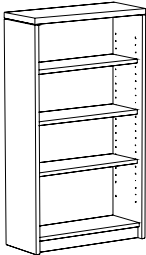

**IMPORTANT:**  
Number of Adjustable shelves:  
29" high = 1  
36" high = 1  
42" high = 2  
48" high = 2  
60" high = 3  
65" high = 3  
72" high = 4  
84" high = 5

**Please Note:**  
29" high units will not accommodate two rows of binders.

Description	Model Number	List Prices - Laminate			Dimensions			Wgt
		Wood Edges			Wide	Deep	High	
		WoodPlus	Standard	Detailed				
<b>30" wide, 12" deep, Finished Back</b>	ST8-BCB-3029-12	<b>719</b>	864	1009	30	12	29	77
	ST8-BCB-3036-12	<b>783</b>	928	1073	30	12	36	86
	ST8-BCB-3042-12	<b>824</b>	969	1114	30	12	42	94
	ST8-BCB-3048-12	<b>868</b>	1013	1158	30	12	48	109
	ST8-BCB-3060-12	<b>996</b>	1141	1286	30	12	60	135
	ST8-BCB-3065-12	<b>1058</b>	1203	1348	30	12	65	179
	ST8-BCB-3072-12	<b>1104</b>	1249	1394	30	12	72	177
	ST8-BCB-3084-12	<b>1208</b>	1353	1498	30	12	84	185
Doors NOT available; use ST8-SC cabinets. Shelf finish matches case finish.								
<b>30" wide, 15" deep, Finished Back</b>	ST8-BCB-3029-15	<b>719</b>	864	1009	30	15	29	89
	ST8-BCB-3036-15	<b>783</b>	928	1073	30	15	36	98
	ST8-BCB-3042-15	<b>824</b>	969	1114	30	15	42	108
	ST8-BCB-3048-15	<b>868</b>	1013	1158	30	15	48	125
	ST8-BCB-3060-15	<b>996</b>	1141	1286	30	15	60	156
	ST8-BCB-3065-15	<b>1058</b>	1203	1348	30	15	65	179
	ST8-BCB-3072-15	<b>1104</b>	1249	1394	30	15	72	203
	ST8-BCB-3084-15	<b>1208</b>	1353	1498	30	15	84	212
Doors NOT available; use ST8-SC cabinets. Shelf finish matches case finish.								
<b>36" wide, 12" deep, Finished Back</b>	ST8-BCB-3629-12	<b>719</b>	864	1009	36	12	29	86
	ST8-BCB-3636-12	<b>783</b>	928	1073	36	12	36	95
	ST8-BCB-3642-12	<b>824</b>	969	1114	36	12	42	104
	ST8-BCB-3648-12	<b>868</b>	1013	1158	36	12	48	121
	ST8-BCB-3660-12	<b>996</b>	1141	1286	36	12	60	150
	ST8-BCB-3665-12	<b>1091</b>	1236	1381	36	12	65	173
	ST8-BCB-3672-12	<b>1137</b>	1282	1427	36	12	72	197
	ST8-BCB-3684-12	<b>1245</b>	1390	1535	36	12	84	205
Doors NOT available; use ST8-SC cabinets. Shelf finish matches case finish.								
<b>36" wide, 15" deep, Finished Back</b>	ST8-BCB-3629-15	<b>719</b>	864	1009	36	15	29	99
	ST8-BCB-3636-15	<b>783</b>	928	1073	36	15	36	109
	ST8-BCB-3642-15	<b>824</b>	969	1114	36	15	42	120
	ST8-BCB-3648-15	<b>868</b>	1013	1158	36	15	48	139
	ST8-BCB-3660-15	<b>996</b>	1141	1286	36	15	60	173
	ST8-BCB-3665-15	<b>1091</b>	1236	1381	36	15	65	199
	ST8-BCB-3672-15	<b>1137</b>	1282	1427	36	15	72	226
	ST8-BCB-3684-15	<b>1245</b>	1390	1535	36	15	84	236
Doors NOT available; use ST8-SC cabinets. Shelf finish matches case finish.								

### Edge Options Information

Modular 8 Tops are 1 3/4" thick, available with the following edge options:

#### WoodPlus (PVC)

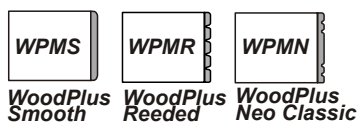

WoodPlus 3 mm PVC edge:  
WPMS - 3 mm Smooth  
WPMR - 3 mm Reeded  
WPMN - 3 mm Neo Classic

#### Standard Wood Edges

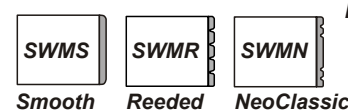

Standard 3 mm Wood Edge:  
SWMS - 3 mm Radius  
SWMR - 3 mm Reeded  
SWMN - 3 mm NeoClassic

#### Detailed Wood Edges

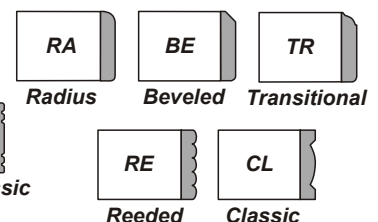

Detailed 3/8" Wood Edge:  
RA - Radiused RE - Reeded  
BE - Beveled CL - Classic  
TR - Transitional

## Storage Towers - Bookcases

### Storage Tower Bookcases - Bow Front Top, Black Hardboard Back

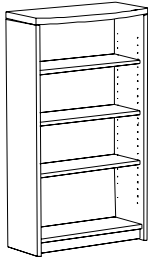

NOTES:  
Shelf depth on 12" deep units is 10-1/2"  
Shelf depth on 15" deep units is 13-1/2"  
Weight limit is 100 lb per shelf.  
Shelves are adjustable on 2" increments.

**Please Note:**  
29" high units will not accommodate two rows of binders.

Description	Model Number	List Prices - Laminate			Dimensions			Wgt
		Wood Edges			Wide	Deep	High	
		WoodPlus	Standard	Detailed				
<b>30" wide, 12" deep Black Back</b>	STB8-BCK-3029-12	<b>748</b>	893	1038	30	12	29	77
	STB8-BCK-3036-12	<b>661</b>	806	951	30	12	36	86
	STB8-BCK-3042-12	<b>702</b>	847	992	30	12	42	94
	STB8-BCK-3048-12	<b>743</b>	888	1033	30	12	48	109
	STB8-BCK-3060-12	<b>862</b>	1007	1152	30	12	60	135
	STB8-BCK-3065-12	<b>924</b>	1069	1214	30	12	65	179
	STB8-BCK-3072-12	<b>968</b>	1113	1258	30	12	72	177
	STB8-BCK-3084-12	<b>1047</b>	1192	1337	30	12	84	185
Doors NOT available; use STB8-SC cabinets. Shelf finish matches case finish.								
<b>30" wide, 15" deep Black Back</b>	STB8-BCK-3029-15	<b>748</b>	893	1038	30	15	29	73
	STB8-BCK-3036-15	<b>661</b>	806	951	30	15	36	77
	STB8-BCK-3042-15	<b>702</b>	847	992	30	15	42	78
	STB8-BCK-3048-15	<b>743</b>	888	1033	30	15	48	99
	STB8-BCK-3060-15	<b>862</b>	1007	1152	30	15	60	121
	STB8-BCK-3065-15	<b>924</b>	1069	1214	30	15	65	139
	STB8-BCK-3072-15	<b>968</b>	1113	1258	30	15	72	150
	STB8-BCK-3084-15	<b>1047</b>	1192	1337	30	15	84	170
Doors NOT available; use STB8-SC cabinets. Shelf finish matches case finish.								
<b>36" wide, 12" deep Black Back</b>	STB8-BCK-3629-12	<b>748</b>	893	1038	36	12	29	86
	STB8-BCK-3636-12	<b>661</b>	806	951	36	12	36	95
	STB8-BCK-3642-12	<b>702</b>	847	992	36	12	42	104
	STB8-BCK-3648-12	<b>743</b>	888	1033	36	12	48	121
	STB8-BCK-3660-12	<b>862</b>	1007	1152	36	12	60	150
	STB8-BCK-3665-12	<b>939</b>	1084	1229	36	12	65	173
	STB8-BCK-3672-12	<b>985</b>	1130	1275	36	12	72	197
	STB8-BCK-3684-12	<b>1065</b>	1210	1355	36	12	84	205
Doors NOT available; use STB8-SC cabinets. Shelf finish matches case finish.								
<b>36" wide, 15" deep Black Back</b>	STB8-BCK-3629-15	<b>748</b>	893	1038	36	15	29	81
	STB8-BCK-3636-15	<b>661</b>	806	951	36	15	36	86
	STB8-BCK-3642-15	<b>702</b>	847	992	36	15	42	99
	STB8-BCK-3648-15	<b>743</b>	888	1033	36	15	48	110
	STB8-BCK-3660-15	<b>862</b>	1007	1152	36	15	60	168
	STB8-BCK-3665-15	<b>939</b>	1084	1229	36	15	65	154
	STB8-BCK-3672-15	<b>985</b>	1130	1275	36	15	72	167
	STB8-BCK-3684-15	<b>1065</b>	1210	1355	36	15	84	189
Doors NOT available; use STB8-SC cabinets. Shelf finish matches case finish.								

#### Options

Options are built-in at factory  
GRV End Panel Grommet

#### Accessories

Order Separately  
ESHExtra Shelf, WoodPlus edge  
ESHExtra Shelf, Wood edge  
Please specify cabinet.

For information on these and other available options and accessories, please see the end of this section.

**See end of this section for pricing on all Options and Accessories**

# Storage Towers - Bookcases

## Storage Tower Bookcases - Bow Front Top, 3/4" Finished Back

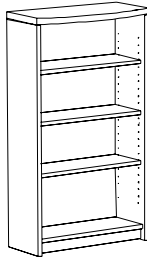

**IMPORTANT:**  
Number of  
Adjustable  
shelves:  
29" high = 1  
36" high = 1  
42" high = 2  
48" high = 2  
60" high = 3  
65" high = 3  
72" high = 4  
84" high = 5

**Please Note:**  
29" high units  
will not  
accommodate  
two rows of  
binders.

Description	Model Number	List Prices - Laminate			Dimensions			Wgt
		Wood Edges			Wide	Deep	High	
		WoodPlus	Standard	Detailed				
<b>30" wide, 12" deep, Finished Back</b>	STB8-BCB-3029-12	<b>910</b>	1055	1200	30	12	29	77
	STB8-BCB-3036-12	<b>822</b>	967	1112	30	12	36	86
	STB8-BCB-3042-12	<b>872</b>	1017	1162	30	12	42	94
	STB8-BCB-3048-12	<b>921</b>	1066	1211	30	12	48	109
	STB8-BCB-3060-12	<b>1068</b>	1213	1358	30	12	60	135
	STB8-BCB-3065-12	<b>1141</b>	1286	1431	30	12	65	179
	STB8-BCB-3072-12	<b>1187</b>	1332	1477	30	12	72	177
	STB8-BCB-3084-12	<b>1291</b>	1436	1581	30	12	84	184
Doors NOT available; use STB8-SC cabinets. Shelf finish matches case finish.								
<b>30" wide, 15" deep, Finished Back</b>	STB8-BCB-3029-15	<b>910</b>	1055	1200	30	15	29	89
	STB8-BCB-3036-15	<b>822</b>	967	1112	30	15	36	98
	STB8-BCB-3042-15	<b>872</b>	1017	1162	30	15	42	108
	STB8-BCB-3048-15	<b>921</b>	1066	1211	30	15	48	125
	STB8-BCB-3060-15	<b>1068</b>	1213	1358	30	15	60	156
	STB8-BCB-3065-15	<b>1141</b>	1286	1431	30	15	65	179
	STB8-BCB-3072-15	<b>1187</b>	1332	1477	30	15	72	203
	STB8-BCB-3084-15	<b>1291</b>	1436	1581	30	15	84	212
Doors NOT available; use STB8-SC cabinets. Shelf finish matches case finish.								
<b>36" wide, 12" deep, Finished Back</b>	STB8-BCB-3629-12	<b>910</b>	1055	1200	36	12	29	86
	STB8-BCB-3636-12	<b>822</b>	967	1112	36	12	36	95
	STB8-BCB-3642-12	<b>872</b>	1017	1162	36	12	42	104
	STB8-BCB-3648-12	<b>921</b>	1066	1211	36	12	48	121
	STB8-BCB-3660-12	<b>1068</b>	1213	1358	36	12	60	150
	STB8-BCB-3665-12	<b>1173</b>	1318	1463	36	12	65	173
	STB8-BCB-3672-12	<b>1220</b>	1365	1510	36	12	72	197
	STB8-BCB-3684-12	<b>1329</b>	1474	1619	36	12	84	205
Doors NOT available; use STB8-SC cabinets. Shelf finish matches case finish.								
<b>36" wide, 15" deep, Finished Back</b>	STB8-BCB-3629-15	<b>910</b>	1055	1200	36	15	29	99
	STB8-BCB-3636-15	<b>822</b>	967	1112	36	15	36	109
	STB8-BCB-3642-15	<b>872</b>	1017	1162	36	15	42	120
	STB8-BCB-3648-15	<b>921</b>	1066	1211	36	15	48	139
	STB8-BCB-3660-15	<b>1068</b>	1213	1358	36	15	60	173
	STB8-BCB-3665-15	<b>1173</b>	1318	1463	36	15	65	199
	STB8-BCB-3672-15	<b>1220</b>	1365	1510	36	15	72	226
	STB8-BCB-3684-15	<b>1329</b>	1474	1619	36	15	84	236
Doors NOT available; use STB8-SC cabinets. Shelf finish matches case finish.								

### Edge Options Information

Modular 8 Tops are 1 3/4" thick, available with the following edge options:

#### WoodPlus (PVC)

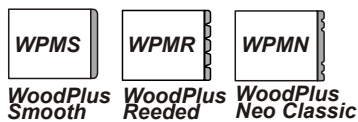

WoodPlus 3 mm PVC edge:  
WPMS - 3 mm Smooth  
WPMR - 3 mm Reeded  
WPMN - 3 mm Neo Classic

#### Standard Wood Edges



Standard 3 mm Wood Edge:  
SWMS - 3 mm Radius  
SWMR - 3 mm Reeded  
SWMN - 3 mm NeoClassic

#### Detailed Wood Edges

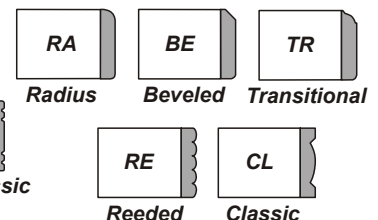

Detailed 3/8" Wood Edge:  
RA - Radiused RE - Reeded  
BE - Beveled CL - Classic  
TR - Transitional

# Storage Towers, Audio-Video

## Overview - Storage Towers - Audio-Video

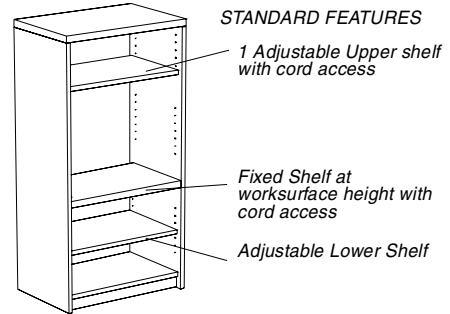
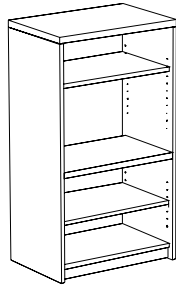

AV Storage, 72" High  
30" or 36" wide, 24" deep

Storage Towers - Rectangular Top, Audio Video, see Pg 150

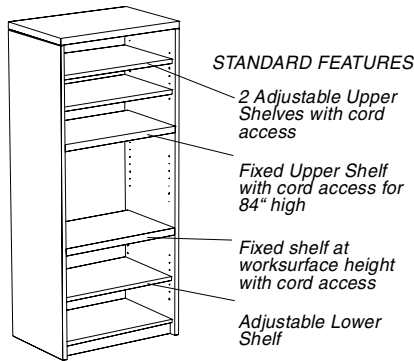

AV Storage, 84" High  
30" or 36" wide, 24" deep

All Video Towers are supplied with a Vertical Grommet in back, located below the fixed work surface.

### Door Options

Upper Door Options:

- UPD Upper Pocket Doors
- UHD Upper Hinged Doors
- GDW Glass with WoodPlus2 Frame
- GDA Glass with Aluminum frame

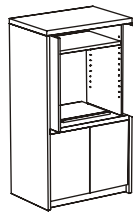

UPD

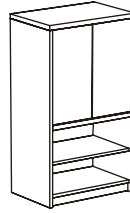

UHD  
165° hinges

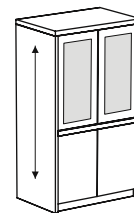

GDW  
165° hinges

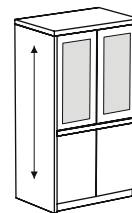

GDA  
165° hinges

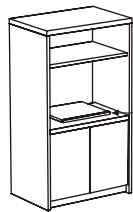

LHD

LHD  
Lower Hinged Doors

TVT

## Storage Towers, Audio-Video

### Storage Towers - Rectangular Top, Audio Video

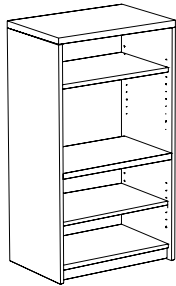

Description	Model Number	List Prices - Laminate			Dimensions			Wgt
		Wood Edges			Wide	Deep	High	
		WoodPlus	Standard	Detailed				
<b>Audio Video Cabinet, 65" high, 24" deep</b>	STV8-3065-24	<b>1334</b>	1527	1691	30	24	65	276
	STV8-3665-24	<b>1392</b>	1585	1749	36	24	65	301
<b>72" high</b>	STV8-3072-24	<b>1383</b>	1576	1740	30	24	72	312
	STV8-3672-24	<b>1439</b>	1632	1796	36	24	72	339
<b>84" high</b>	STV8-3084-24	<b>1500</b>	1693	1857	30	24	84	312
	STV8-3684-24	<b>1565</b>	1758	1922	36	24	84	339

Shelf finish matches case finish.

### Storage Towers - Bow Front Top, Audio Video

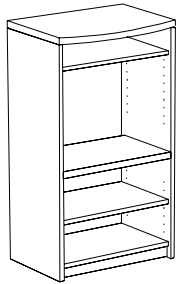
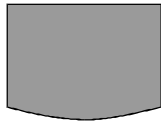

Description	Model Number	List Prices - Laminate			Dimensions			Wgt
		Wood Edges			Wide	Deep	High	
		WoodPlus	Standard	Detailed				
<b>65" high, Audio Video Cabinet, 24" deep</b>	STVB8-3065-24	<b>1428</b>	1621	1785	30	24	65	276
	STVB8-3665-24	<b>1488</b>	1681	1845	36	24	65	301
<b>72" high</b>	STVB8-3072-24	<b>1477</b>	1670	1834	30	24	72	312
	STVB8-3672-24	<b>1534</b>	1727	1891	36	24	72	339
<b>84" high</b>	STVB8-3084-24	<b>1596</b>	1789	1953	30	24	84	312
	STVB8-3684-24	<b>1661</b>	1854	2018	36	24	84	339

Shelf finish matches case finish.

#### Edge Options Information

Modular 8 Tops are 1 3/4" thick, available with the following edge options:

#### WoodPlus (PVC)

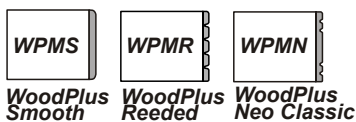

WoodPlus 3 mm PVC edge:  
 WPMS - 3 mm Smooth  
 WPMR - 3 mm Reeded  
 WPMN - 3 mm Neo Classic

#### Standard Wood Edges

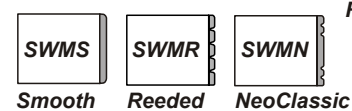

Standard 3 mm Wood Edge:  
 SWMS - 3 mm Radius  
 SWMR - 3 mm Reeded  
 SWMN - 3 mm NeoClassic

#### Detailed Wood Edges

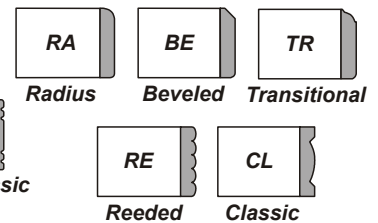

Detailed 3/8" Wood Edge:  
 RA - Radius  
 BE - Beveled  
 TR - Transitional  
 RE - Reeded  
 CL - Classic



## Storage Towers, Audio-Video

### Options for Video Towers

Description	Model Number	List Price	Dimensions			Wgt
			Wide	Deep	High	
<b>Vertical Grommet</b>	OPTION-GRV	<b>48</b>	2.75	0	4.25	

Grommet opening: 2.00" X 3.50"  
One Grommet is included on Video Towers - located in center back, below the fixed worksurface.

<b>Locks for Doors</b>	OPTION-LOCK-PAIR-DOORS	<b>87</b>				
------------------------	------------------------	-----------	--	--	--	--

<b>Upper Pocket Doors</b>	OPTION-UPD	<b>1001</b>				<b>89</b>
---------------------------	------------	-------------	--	--	--	-----------

Pocket Doors slide into cabinet when open, and are full height from top of fixed worksurface to top of cabinet. Specify Pull number.

<b>Upper Hinged Doors</b>	OPTION-UHD	<b>353</b>				<b>33</b>
---------------------------	------------	------------	--	--	--	-----------

Upper Hinged Doors use 165 degree hinges and extend from top of fixed worksurface to top of cabinet. Specify Pull number.

<b>Glass Doors WoodPlus2 frame</b>	OPTION-UGW	<b>791</b>				<b>45</b>
------------------------------------	------------	------------	--	--	--	-----------

WoodPlus2 glass door frames are detailed to match Modular 8 details. Glass is frosted. No pulls or locks available with glass doors. Specify WP2 or XTRA WP2 finish for the door frames. Note that the XTRA WP2 upcharge applies when choosing an XTRA WP2 finish.

<b>Glass Doors Aluminum frame</b>	OPTION-UGA	<b>791</b>				<b>45</b>
-----------------------------------	------------	------------	--	--	--	-----------

Glass Doors use 165 degree hinges and extend from top of fixed worksurface to top of cabinet. No pulls or lock available. MAGNA NOW! Glass Doors are NOT available on MAGNA NOW!

<b>Lower Hinged Doors</b>	OPTION-LHD	<b>353</b>				<b>25</b>
---------------------------	------------	------------	--	--	--	-----------

Lower Hinged Doors use 105 degree hinges. Specify Pull number.

### Upper and Lower Door Pull Options and Locations

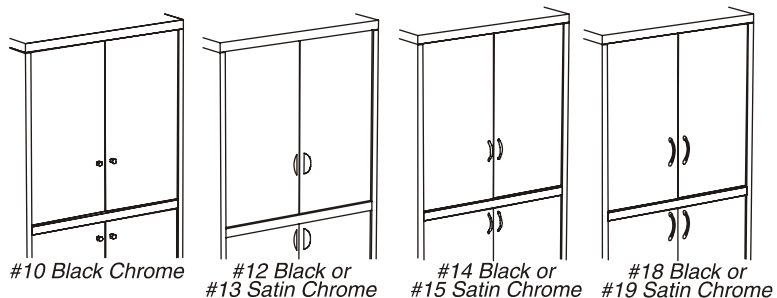

## Storage Towers, Audio-Video

### Accessories for Video Storage Towers

Description	Model Number	List Price	Dimensions			Wgt
			Wide	Deep	High	
<b>Extra adjustable Shelves - any size</b>	ESH-WPE	<b>57</b>				15
	ESH-STD	<b>82</b>				15

Tower shelves match tower vertical finish.

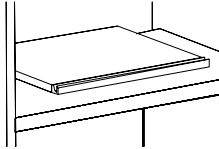

Extends 11-1/2"  
Swivels 180°  
Load limit: 200 lb.

TV Tray	Model Number	List Price	Wide	Deep	High	Wgt
	TVT-30-WS	<b>592</b>	15	18	0.75	25
	TVT-36-WS	<b>592</b>	20	18	0.75	35

Finish is Black.

To order as an Accessory, use model number TVT-30 for 30" wide towers and TVT-36 for 36" wide towers.

To order as an Option, specify location:

1. For worksurface location (for any height Tower) add "TVT-WS" to end of model number.
2. For upper fixed shelf location for 84" high Towers add "TVT-SH" to end of model number.

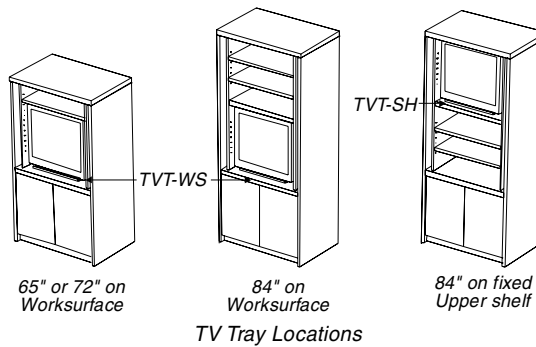

#### Clearance for TV

Cabinet Width	Open - No Doors			Hinged or Pocket Doors		
	W	H	D	W	H	D
30"	27-3/4	23-5/8*	22	22-1/4	23-5/8*	21-1/8
36"	33-3/4	23-5/8*	22	28-1/4	23-5/8*	21-1/8

\*with TVT Tray - 25-3/8 without TVT

## Mobile Units

### Overview - Mobile Units, Pedestals

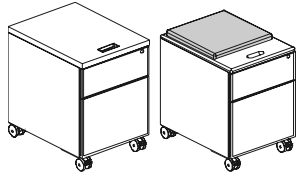

Mobile Pedestals, see Pg 154

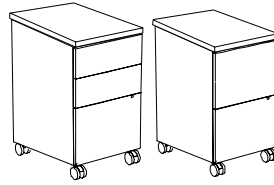

Mobile Pedestals, see Pg 154

### Overview - Mobile Units, Laptop Storage

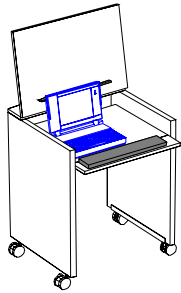

### Overview - Mobile Units, Cabinets

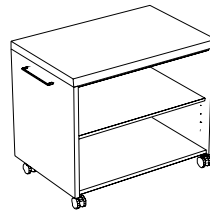
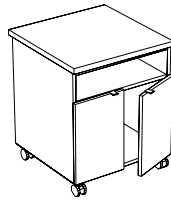

Mobile Coffee and Storage Carts, see Pg 155

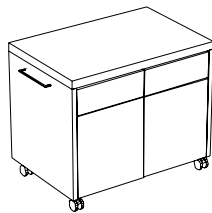
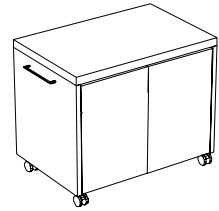

Mobile Projection Stand Carts, see Pg 155

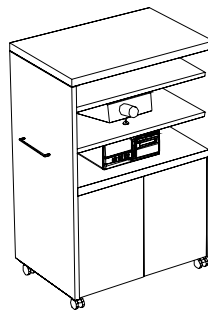

Mobile Projection Stand Carts, see Pg 155

## Mobile Units

### Mobile Pedestals

Description	Model Number	Dimensions			Wgt	List Prices		
		Wide	Deep	High		Wood Edges		
					WoodPlus	Standard	Detailed	
<b>Mobile 3/4 Pedestal</b>	M8-PM-BF-LOCK	16	24	27	75	<b>1101</b>	1101	1101
	Option M8-PM-Cushion	24	16		5	<b>88</b>	88	88

M8-PM Box / File Pedestal with lock, on casters, may be stored underneath a worktop. Please specify pull number.  
Optional Black vinyl cushion maybe ordered for the top of pedestal case.

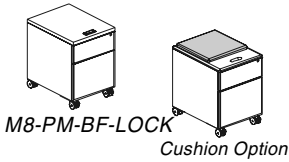

<b>Mobile Docking Pedestals</b>	M8-PD-DB-LOCK	16	24	29	82	<b>1280</b>	1280	1280
	M8-PD-DF-LOCK	16	24	29	82	<b>1280</b>	1280	1280

M8-PD-DB Box/Box/File pedestal with lock, on casters, includes a worktop, 16w x 24d.  
M8-PD-DF File/File pedestal with lock, on casters, includes a worktop 16w x 24d. Please specify pull number.  
The M8-PD pedestal can be 'docked' next to a worktop to extend the worktop surface.

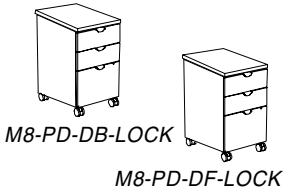

<b>Mobile Laptop Storage</b>	CRM-MLS	24	21	30	68	<b>1181</b>	1181	1181
------------------------------	---------	----	----	----	----	-------------	------	------

Includes lock.

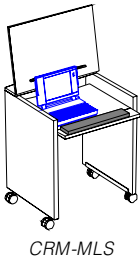

### Mobile Printer Cabinet

<b>Printer Cabinet</b>	CRM-2424-29-PC	24	24	30	112	<b>1463</b>	1608	1753
------------------------	----------------	----	----	----	-----	-------------	------	------

Open shelf with hinged doors below. Specify pull number for hinged doors.

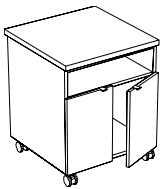

### Drawer and Door Pull Options

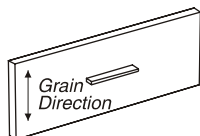

#10 Pulls are an applied metal pull: finish is Black Chrome

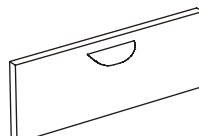

#12 and #13 Pulls are an applied metal pull: #12 finish is Black; #13 is Satin Chrome

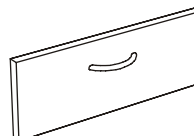

#14 and #15 Pulls are an applied metal pull: #14 finish is Black; #15 is Satin Chrome

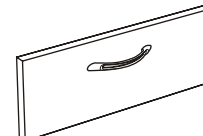

#18 and #19 Pulls are an applied metal pull: #18 finish is Black; #19 is Satin Chrome

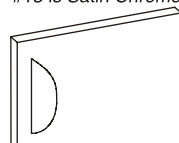
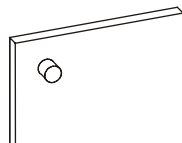

## Mobile Units

### Mobile Coffee and Storage Carts

Description	Model Number	Dimensions			Wgt	List Prices		
		Wide	Deep	High		Wood Edges		
					WoodPlus	Standard	Detailed	
30" wide, 30" high	CRM-2430-29-O	30	24	30	127	<b>1071</b>	1216	1361
	CRM-2430-29-D	30	24	30	127	<b>1463</b>	1608	1753
	CRM-2430-29-BD	30	24	30	127	<b>1758</b>	1903	2048

Specify side pull finish as black or silver.

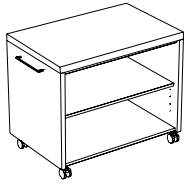

CRM-2436-30-0

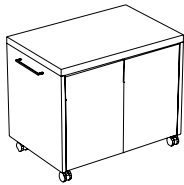

CRM-2436-30-D

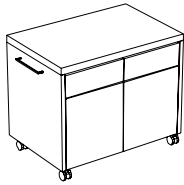

CRM-2436-30-BD

36" wide, 30" high	CRM-2436-29-O	36	24	30	142	<b>1071</b>	1216	1361
	CRM-2436-29-D	36	24	30	142	<b>1463</b>	1608	1753
	CRM-2436-29-BD	36	24	30	142	<b>1758</b>	1903	2048

Specify pull number for doors.

Side pull finish matches the finish on the doors.

### Mobile Projection Stand Carts

54" high	CRM-2430-54-PROJ	30	24	54	134	<b>2116</b>	2261	2406
	CRM-2436-54-PROJ	36	24	54	149	<b>2180</b>	2325	2470
65" high	CRM-2430-65-PROJ	30	24	65	134	<b>2171</b>	2364	2528
	CRM-2436-65-PROJ	36	24	65	149	<b>2235</b>	2428	2592

Specify pull number lower hinged doors.

Side pull finish matches the finish on the doors

Specify pull number lower hinged doors.

Side pull finish matches the finish on the doors

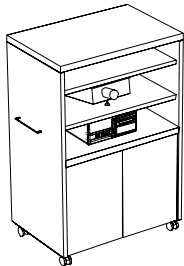

#### Notes:

- Mobile units are equipped with two Locking casters.

#### Options

Options are built-in at factory

- L Lock for Single Door
- L Lock for Pair of Doors
- L Lock for two Pair of Doors
- L Lock for Pedestal

INLAY -available ONLY with Detailed edge

INP Black 3mm (1/8") Inlay:  
Rectangular tops

INB Brushed Brass 3mm Inlay or  
INC Satin Chrome 3mm Inlay:  
Rectangular tops

#### Accessories

Order Separately

- Extra Shelves
- ESH Laminate WPE
- ESH Laminate Wood edge

For information on these and other available options and accessories, as well as for pricing, please see the end of this section.

## Mobile Unit - Options and Accessories

### Mobile Cabinet Options

Description	Model Number	Dimensions			Wgt	List Price
		Wide	Deep	High		
<b>Grommets</b>	GR	4.25	2.75			<b>48</b>



GR=Grommet with cover. Opening: 2 x 3.5

Grommet location is at left rear corner.

<b>Inserts for grommets</b>	WHT-INSERT	4.25	2.75	5	1	<b>148</b>
	DVR-INSERT	4.25	2.75	5	1	<b>67</b>
	PDC-INSERT	4.25	2.75	5	1	<b>139</b>

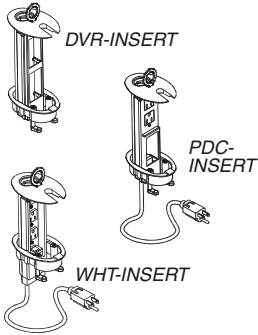

WHT fits into an existing GR grommet; GR must be ordered separately.

WHT is a work surface pop-up with three outlets and is provided with a 6 foot, 15 amp cord. Pull-up size: 2 x 3.5 x 5-1/8" high when extended.

Finish is satin Black.

DVR fits into an existing GR grommet; GR must be ordered separately.

DVR is a work surface pop-up that accepts various receptacle plates to be supplied by your electrical contractor or supplier.

**DVR does not include any receptacles or receptacle plates.**

Pull-up size: 2 x 3.5 x 5-1/8" high when extended.

Finish is satin Black.

PDC fits into an existing GR grommet; GR must be ordered separately.

PDC is a work surface pop-up with two outlets and it accepts one receptacle plate to be supplied by your electrical contractor or supplier.

**PDC does not include any receptacles or receptacle plates.**

Pull-up size: 2 x 3.5 x 5-1/8" high when extended.

Finish is satin Black.

<b>Vertical Grommets</b>	OPTION-GRV	2.75	0	4.25	0	<b>48</b>
--------------------------	------------	------	---	------	---	-----------

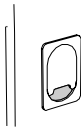

Specify Location as Left (side panel), Right (side panel) or Back.

<b>Wiremanager with Data Bezel</b>	CRM Data-Electrical				2	<b>126</b>
------------------------------------	---------------------	--	--	--	---	------------

Wiremanager supplied with bezel and blank inserts. Data and /or Voice inserts to be supplied by electrical contractor. Includes power strip with 6 grounded outlets, reset-able overload circuit breaker, and 6' cord with plug.

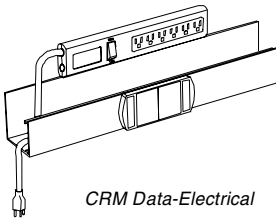

CRM Data-Electrical

<b>Door Locks</b>	LOCK-DOORS					<b>87</b>
-------------------	------------	--	--	--	--	-----------

### Mobile Cabinet Accessories

<b>Additional Shelves</b>	ESH-WPE					<b>57</b>
	ESH-STD					<b>82</b>

## Conference & Meeting Products - Index

Code	Description	Page	Code	Description	Page
<b>A</b>					
Accent	Base accent, silver or black	51, 90			
Accent	METRO base accent	57			
Accent	Conference table top accent	57			
ACE	ACT Table overview of table shapes	20			
	ACT Table plan view of table tops	21			
	Duplex and Insert layouts	22 - 23 - 24			
	ACT table monument locations	25 to 31			
<b>B</b>					
Base	ACT table monument locations	25 to 31			
Base	Distance between conference table bases	58			
BHD	Base Hinged Door	51, 57, 90			
BE	Bow End option, Tables	50, 87			
BEZEL	add Bezel cutout to ACT table	53			
<b>C</b>					
C3R	3" radius corners on table top	50, 87, 110			
Cable Cubby 300C		88, 109, 114			
CENTER	ACT power entry moved to center base	51			
CLAM	ACT table 'CLAM'	51			
CLAM	Conference table 'CLAM'	90			
CMR	Mobile Units	153			
CPU	CPU storage in table base	52			
CRL	Lecterns	119			
CRL-MF	Multimedia lecterns, flat top	120			
CRL-MS	Multimedia lecterns, sloped top	121			
CRM	Mobile units	153			
CUBE	Cube Tables	136			
<b>Credenzas</b>					
Overview		123			
CRC-TOP	in M8, EQ, S50, WP2	124 to 130			
CRC-CAB	in M8, EQ, S50, WP2	125 to 131			
TRI-BASE	Credenza with TRI base	132			
	Credenza top between towers	134			
<b>D</b>					
DRUM	Drum Tables	136			
DRW	Display rails, wall mounted	117			
DVR	DVR-INSERT	88, 109, 114, 119			
<b>E</b>					
Rack	Add equipment rack to table base	52			
ESH	Extra Adjustable Shelves	144, 152, 156			
<b>F</b>					
Finishes		18			
Flat Screen storage in ACT table		50			
Freight surcharge		7			
Fuel surcharge		7			
<b>G</b>					
Grommet locations in conference tables		88			
GR	Grommet in top	88, 109, 114, 119			
GRV	Grommet, Vertical,	109, 144, 151			
<b>I</b>					
INLAY	Inlay for Tables	50, 87, 99, 109			
INSERT	Inserts for ACT tables	53			
INSERT	for MINI-ACTS, MINIPORTS, INTERPORTS	57			
INSERT	DVR-INSERT	88, 109, 114, 119			
INSERT	PDC-INSERT	88, 109, 114, 119			
INSERT	WHT-INSERT	88, 109, 114, 119			
INTERPORT		88, 109, 114, 119			
<b>L</b>					
Warranty, Lifetime		7			
Layout guide and room size		14			
L	Lock	119, 116, 144, 151			
<b>M</b>					
NOW!	Magna NOW! tables ship in 10 days	3			
M8-PD	Mobile Docking Pedestals	154			
M8-PM	3/4 high Mobile Pedestal	154			
MB	Marker Board	118			
METRO BASE ACCENT		57			
MJT	Wiremanager	99			
MINIACT power and data inserts		57			
MINIPORT		88, 109, 114			
MUT	Mobile Utility table	35, 68, 108			
MWB	Mobile White Board	117			
<b>N</b>					
NOW!	Magna NOW! tables ship in 10 days	3			
NU	notches in table bases	51, 90			
<b>P</b>					
PDB	Presentation Display Board	116			
PDBM	Presentation Display, Magnetic	116			
PDC	PDC-INSERT	88, 109, 114, 119			
Polycom	Polycom storage in table base	53			
Planning Guide		9			
Pricing and Delivery		7			
PSV	Projection Valance	115			
<b>R</b>					
Rack	Add equipment rack to table base	52			
RC	Radius Corner option, Tables	50, 87			
RMN	Table wiremanager	90, 99			
Room size and Layout guide		14			
<b>S</b>					
Seating Capacity		12			
SLIDE	Slide table	86, 108			
Spec	Quick spec guide	4			
Specifications, ACT and Kaizen tables, WP		15			
Specifications, ACT tables, WP2		17			
Specifications, Conference tables, WP		15			
Specifications, Conference tables, WP2		17			
ST8...LF	Storage tower with lateral file drawers	137			
ST8...BC	Bookcases	145			
STV	Video towers	149			

## Conference & Meeting Products - Index

<i>Code</i>	<i>Description</i>	<i>Page</i>	<i>Code</i>	<i>Description</i>	<i>Page</i>
<b>Storage Towers, rectangular tops</b>			<b>Tables, Modular Conference</b>		
ST8-BC	Bookcases -----	145	Overview	-----	91
ST8-LF	Storage Tower, Lateral Files -----	137	MT-101 through MT-105 configurations -----		92 to 96
Doors	-----	144	SECTIONS for modular conference tables -----		97
<b>Storage Towers, Bow Front tops</b>				MT-TT, MT-TZ, MT-THL, MT-THR, MT-SC, MT-SA	
STB8-BC	Storage Tower Bookcases -----	141	FILLERS for modular conference tables -----		98
STB8-LF	Storage Tower, Lateral Files -----	141	MT-FC, MT-FA		
Doors	-----	144	MT-KP	Kneespace protectors -----	99
<b>Video Towers</b>			WEDGE	added to table bases -----	99
STV8	Video Towers -----	149	<b>Tables, Modular</b>		
STVB8	Video Towers, Bow Front Tops -----	150	Overview	-----	101
Doors	-----	151	TD	Round Tables -----	102
<b>T</b>			THR	Half Round Tables -----	103
TOP ACCENT	-----	57	TK	Kidney Shape Table -----	104
Table edges	-----	10, 10	TQR	Quarter Round corner filler top -----	103
TC	Modular Table Top Connectors -----	110	TRAP	Trapezoid shaped top -----	104
Terms and Conditions	-----	7	TS	Square Table -----	105
TILT-N-PLUG	-----	88, 115, 119	TT	Rectangle Tables -----	105 to 107
TVT	TV Tray, Video Towers -----	151	TT CLEG	Rectangle Tables with C LEG base -----	107
<b>Tables, ACT</b>			MUT	Mobile Utility Table -----	108
Overview of table shapes	-----	12	SLIDE	Slide table -----	108
Plan view of table tops	-----	21	<b>Tables, Modular Assemblies</b>		
Duplex and Insert layout	-----	24	Overview	-----	111
Table base monument locations -----			TMOR	Modular Table Assemblies 'O' Shape -----	112
	RC, HC, CYL, RHC bases -----	31	TMOS	Modular Table Assemblies, 'O' Shape -----	112
	TRI bases -----	29	TMR	Modular Table Assemblies, Racetrack -----	113
	RCN, HCN, METRO bases -----	27	TMT	Modular Table Assemblies, Rectangle -----	113
TAR	Arrow Table -----	36	TMTRAP	Modular Table Assemblies, Hexagonal -----	113
TB	Boat Shape Tables -----	40	INLAYS for Modular Table Assemblies -----		114
TB-BE	Boat Bow End Table WP2 -----	48	<b>U</b>		
TD	Round Table -----	45	UHD	Upper Hinged Doors, Lateral File Towers ---	144
TDE	Delta Tables -----	44	UHD	Upper Hinged Doors, Video Towers -----	151
TEG	Egg Shape Table -----	44	UPD	Upper Pocket Doors, Video Towers -----	151
TEG	Egg Shape Table, WP2 -----	49	<b>V</b>		
TR	Racetrack Tables -----	42	V-BAY	Conference table V-Bay wiremanager -----	57
TR	Racetrack Table, WP2 -----	49	<b>W</b>		
TT	Rectangular Tables -----	38	Warranty, Lifetime -----		7
TT-BE	Rectangular Tables, WP2 -----	47	WEDGE	added to table bases -----	99
TW	Wing Tables -----	46	WHT	WHT-INSERT -----	88, 109, 114, 119
ACT Table OPTIONS	-----	50	Wiremanagers	-----	57, 90, 99
<b>Tables, Kaizen</b>			WL	Work Lights -----	144
TKZ	Kaizen articulating ACT table -----	34	<b>Tables, Conference</b>		
<b>Tables, Conference</b>			TB	Boat Shape Tables -----	74
TB	Boat Shape Tables -----	74	TB-BE	Boat Shape Bow End Table, WP2 -----	82
TB-BE	Boat Shape Bow End Table, WP2 -----	82	TDE	Delta Shape Tables -----	79
TDE	Delta Shape Tables -----	79	TD	Round Table, WP2 -----	74
TD	Round Table, WP2 -----	74	TEG	Egg Shape Tables -----	79
TEG	Egg Shape Tables -----	79	TEG	Egg Shape Table, WP2 -----	85
TEG	Egg Shape Table, WP2 -----	85	TR	Racetrack Table, WP2 -----	83
TR	Racetrack Table, WP2 -----	83	TR	Racetrack Tables -----	3, 77
TR	Racetrack Tables -----	3, 77	TT	Rectangular Conference Tables -----	71
TT	Rectangular Conference Tables -----	71	TT-BE	Rectangular Bow End Table, WP2 -----	81
TT-BE	Rectangular Bow End Table, WP2 -----	81	TW	Wing table -----	80
TW	Wing table -----	80			